

Архангельск (8182)63-90-72
 Астана (7172)727-132
 Астрахань (8512)99-46-04
 Барнаул (3852)73-04-60
 Белгород (4722)40-23-64
 Брянск (4832)59-03-52
 Владивосток (423)249-28-31
 Волгоград (844)278-03-48
 Вологда (8172)26-41-59
 Воронеж (473)204-51-73
 Екатеринбург (343)384-55-89
 Иваново (4932)77-34-06

Ижевск (3412)26-03-58
 Иркутск (395)279-98-46
 Казань (843)206-01-48
 Калининград (4012)72-03-81
 Калуга (4842)92-23-67
 Кемерово (3842)65-04-62
 Киров (8332)68-02-04
 Краснодар (861)203-40-90
 Красноярск (391)204-63-61
 Курск (4712)77-13-04
 Липецк (4742)52-20-81

Магнитогорск (3519)55-03-13
 Москва (495)268-04-70
 Мурманск (8152)59-64-93
 Набережные Челны (8552)20-53-41
 Нижний Новгород (831)429-08-12
 Новокузнецк (3843)20-46-81
 Новосибирск (383)227-86-73
 Омск (3812)21-46-40
 Орел (4862)44-53-42
 Оренбург (3532)37-68-04
 Пенза (8412)22-31-16

Пермь (342)205-81-47
 Ростов-на-Дону (863)308-18-15
 Рязань (4912)46-61-64
 Самара (846)206-03-16
 Санкт-Петербург (812)309-46-40
 Саратов (845)249-38-78
 Севастополь (8692)22-31-93
 Симферополь (3652)67-13-56
 Смоленск (4812)29-41-54
 Сочи (862)225-72-31
 Ставрополь (8652)20-65-13

Сургут (3462)77-98-35
 Тверь (4822)63-31-35
 Томск (3822)98-41-53
 Тула (4872)74-02-29
 Тюмень (3452)66-21-18
 Ульяновск (8422)24-23-59
 Уфа (347)229-48-12
 Хабаровск (4212)92-98-04
 Челябинск (351)202-03-61
 Череповец (8202)49-02-64
 Ярославль (4852)69-52-93

Киргизия (996)312-96-26-47

Россия (495)268-04-70

Казахстан (772)734-952-31

<https://fanar.nt-rt.ru/> || frk@nt-rt.ru

DIN-352

General purpose hand taps for metric and inch threads are available in 2- and 3-piece sets. They are produced of High Speed Steel (HSS). The length of the finishing tap chamfer is ~2xP.

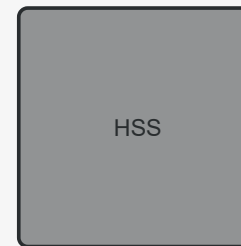

Application

Variants

Variant

Chamfer

Coating type

Execution standard

Set of 2 pcs.



DIN-5157/DIN-2181/DIN-352

Set of 3 pcs.



DIN-352



HSS

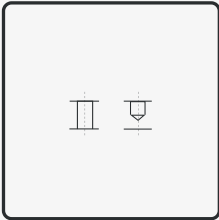

DIN-352

Set of 2 pcs.

General purpose HSSE hand 2- and 3-piece sets.

Select thread variant

M - RH

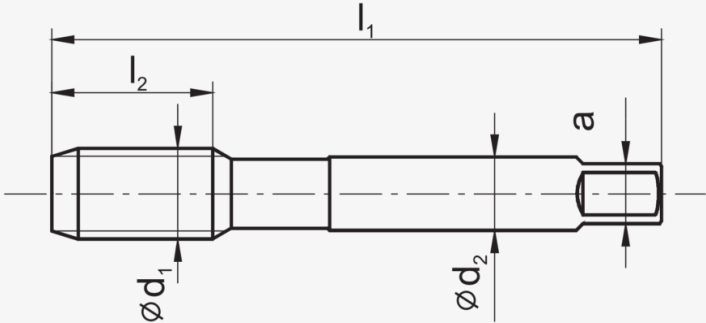

Application

P

M

K









N

S

H

Dimensions

Index	Thread direction	Thread size	P	Pitch diameter tolerance	l ₁	l ₂	l ₃	ød ₂	a	Tapping hole diameter
A1-220001-0030		M3	0,50	ISO2(6H)	40,0	11,0	18,0	3,5	2,70	2,50
A1-220001-0035		M3,5	0,60	ISO2(6H)	45,0	13,0	21,0	4,0	3,00	2,90
A1-220001-0040		M4	0,70	ISO2(6H)	45,0	13,0	21,0	4,5	3,40	3,30
A1-220001-0045		M4,5	0,75	ISO2(6H)	50,0	16,0	25,0	6,0	4,90	3,70

A1-220001-0050		M5	0,80	ISO2(6H)	52,0	16,0	26,0	6,0	4,90	4,20
A1-220001-0060		M6	1,00	ISO2(6H)	56,0	18,0	27,0	6,0	4,90	5,00
A1-220001-0070		M7	1,00	ISO2(6H)	56,0	18,0		6,0	4,90	6,00
A1-220001-0080		M8	1,25	ISO2(6H)	63,0	20,0		6,0	4,90	6,80
A1-220001-0090		M9	1,25	ISO2(6H)	63,0	20,0		7,0	5,50	7,80
A1-220001-0100		M10	1,50	ISO2(6H)	70,0	22,0		7,0	5,50	8,50
A1-220001-0110		M11	1,50	ISO2(6H)	70,0	22,0		8,0	6,20	9,50
A1-220001-0120		M12	1,75	ISO2(6H)	80,0	24,0		9,0	7,00	10,20
A1-220001-0140		M14	2,00	ISO2(6H)	80,0	26,0		11,0	9,00	12,00



A1-220001-0160



M16

2,00

ISO2(6H)

80,0

27,0

12,0

9,00

14,00

A1-220001-0180



M18

2,50

ISO2(6H)

95,0

30,0

14,0

11,00

15,50

A1-220001-0200



M20

2,50

ISO2(6H)

95,0

32,0

16,0

12,00

17,50

A1-220001-0220



M22

2,50

ISO2(6H)

100,0

32,0

18,0

14,50

19,50

A1-220001-0240



M24

3,00

ISO2(6H)

110,0

34,0

18,0

14,50

21,00

A1-220001-0270



M27

3,00

ISO2(6H)

110,0

36,0

20,0

16,00

24,00



HSS

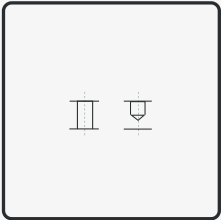

DIN-352

Set of 3 pcs.

General purpose HSSE hand 2- and 3-piece sets.

Select thread variant

M - RH

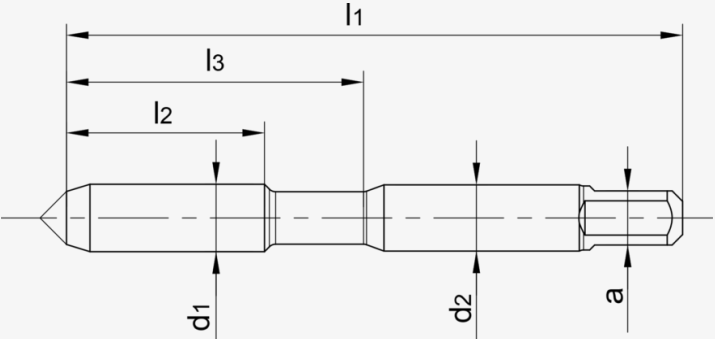

Application

P

M





K









N

S

H

Dimensions

Index	Thread direction	Thread size	P	Pitch diameter tolerance	l ₁	l ₂	l ₃	ød ₂	a	Tapping hole diameter
A1-230002-0010		M1	0,25	ISO1(4H)	32,5	6,5	10,5	2,5	2,10	0,75
A1-230002-0011		M1,1	0,25	ISO1(4H)	32,5	6,5	10,5	2,5	2,10	0,85
A1-230002-0012		M1,2	0,25	ISO1(4H)	32,5	6,5	10,5	2,5	2,10	0,95
A1-230002-0014		M1,4	0,30	ISO1(4H)	32,5	8,0	10,5	2,5	2,10	1,10

A1-230001-0016		M1,6	0,35	ISO2(6H)	41,0	9,0	10,5	2,5	2,10	1,25
A1-230001-0017		M1,7	0,35	ISO2(6H)	41,0	9,0	10,5	2,5	2,10	1,35
A1-230001-0018		M1,8	0,35	ISO2(6H)	41,0	9,0	10,5	2,5	2,10	1,45
A1-230001-0020		M2	0,40	ISO2(6H)	36,0	10,0	10,0	2,8	2,10	1,60
A1-230001-0022		M2,2	0,45	ISO2(6H)	36,0	9,0	13,0	2,8	2,10	1,75
A1-230001-0023		M2,3	0,40	ISO2(6H)	36,0	9,0	13,0	2,8	2,10	1,90
A1-230001-0025		M2,5	0,45	ISO2(6H)	40,0	9,0	15,0	2,8	2,10	2,05
A1-230001-0026		M2,6	0,45	ISO2(6H)	40,0	9,0	15,0	2,8	2,10	2,15
A1-230001-0030		M3	0,50	ISO2(6H)	40,0	11,0	18,0	3,5	2,70	2,50



A1-230001-0035



M3,5

0,60

ISO2(6H)

45,0

13,0

21,0

4,0

3,00

2,90

A1-230001-0040



M4

0,70

ISO2(6H)

45,0

13,0

21,0

4,5

3,40

3,30

A1-230001-0045



M4,5

0,75

ISO2(6H)

50,0

16,0

25,0

6,0

4,90

3,70

A1-230001-0050



M5

0,80

ISO2(6H)

52,0

16,0

26,0

6,0

4,90

4,20

A1-230001-0060



M6

1,00

ISO2(6H)

56,0

18,0

27,0

6,0

4,90

5,00

A1-230001-0070



M7

1,00

ISO2(6H)

56,0

18,0

6,0

4,90

6,00

A1-230001-0080



M8

1,25

ISO2(6H)

63,0

20,0

6,0

4,90

6,80

A1-230001-0090

M9

1,25

ISO2(6H)

63,0

20,0

7,0

5,50

7,80



A1-230001-0100



M10

1,50

ISO2(6H)

70,0

22,0

7,0

5,50

8,50

A1-230001-0110



M11

1,50

ISO2(6H)

70,0

22,0

8,0

6,20

9,50

A1-230001-0120



M12

1,75

ISO2(6H)

80,0

24,0

9,0

7,00

10,20

A1-230001-0140



M14

2,00

ISO2(6H)

80,0

26,0

11,0

9,00

12,00

A1-230001-0160



M16

2,00

ISO2(6H)

80,0

27,0

12,0

9,00

14,00

A1-230001-0180



M18

2,50

ISO2(6H)

95,0

30,0

14,0

11,00

15,50

A1-230001-0200



M20

2,50

ISO2(6H)

95,0

32,0

16,0

12,00

17,50

A1-230001-0220

M22

2,50

ISO2(6H)

100,0

32,0

18,0

14,50

19,50



A1-230001-0240



M24

3,00

ISO2(6H)

110,0

34,0

18,0

14,50

21,00

A1-230001-0270



M27

3,00

ISO2(6H)

110,0

36,0

20,0

16,00

24,00

A1-230001-0300



M30

3,5

ISO2(6H)

125

40

22

18

26,5

A1-230001-0330



M33

3,5

ISO2(6H)

125

40

25

20

29,5

A1-230001-0360



M36

4,0

ISO2(6H)

150

50

28

22

32,0

A1-230001-0390



M39

4,0

ISO2(6H)

150

50

32

24

35,0

A1-230001-0420



M42

4,5

ISO2(6H)

150

56

32

24

37,5

A1-230001-0450

M45

4,5

ISO2(6H)

160

58

36

29

40,5



A1-230001-0480



M48

5,0

ISO2(6H)

180

65

36

29

43,0

A1-230001-0520



M52

5,0

ISO2(6H)

180

65

40

32

47,0

A1-230001-0560



M56

5,5

ISO2(6H)

200

75

45

35

50,5

A1-230001-0600



M60

5,5

ISO2(6H)

200

70

45

35

54,5

A1-230001-0640



M64

6,0

ISO2(6H)

220

75

50

39

58,0

A1-230001-0680



M68

6,0

ISO2(6H)

220

75

50

39

62,0

Архангельск (8182)63-90-72
Астана (7172)727-132
Астрахань (8512)99-46-04
Барнаул (3852)73-04-60
Белгород (4722)40-23-64
Брянск (4832)59-03-52
Владивосток (423)249-28-31
Волгоград (844)278-03-48
Вологда (8172)26-41-59
Воронеж (473)204-51-73
Екатеринбург (343)384-55-89
Иваново (4932)77-34-06

Ижевск (3412)26-03-58
Иркутск (395)279-98-46
Казань (843)206-01-48
Калининград (4012)72-03-81
Калуга (4842)92-23-67
Кемерово (3842)65-04-62
Киров (8332)68-02-04
Краснодар (861)203-40-90
Красноярск (391)204-63-61
Курск (4712)77-13-04
Липецк (4742)52-20-81

Киргизия (996)312-96-26-47

Магнитогорск (3519)55-03-13
Москва (495)268-04-70
Мурманск (8152)59-64-93
Набережные Челны (8552)20-53-41
Нижний Новгород (831)429-08-12
Новокузнецк (3843)20-46-81
Новосибирск (383)227-86-73
Омск (3812)21-46-40
Орел (4862)44-53-42
Оренбург (3532)37-68-04
Пенза (8412)22-31-16

Россия (495)268-04-70

Пермь (342)205-81-47
Ростов-на-Дону (863)308-18-15
Рязань (4912)46-61-64
Самара (846)206-03-16
Санкт-Петербург (812)309-46-40
Саратов (845)249-38-78
Севастополь (8692)22-31-93
Симферополь (3652)67-13-56
Смоленск (4812)29-41-54
Сочи (862)225-72-31
Ставрополь (8652)20-65-13

Казахстан (772)734-952-31

Сургут (3462)77-98-35
Тверь (4822)63-31-35
Томск (3822)98-41-53
Тула (4872)74-02-29
Тюмень (3452)66-21-18
Ульяновск (8422)24-23-59
Уфа (347)229-48-12
Хабаровск (4212)92-98-04
Челябинск (351)202-03-61
Череповец (8202)49-02-64
Ярославль (4852)69-52-93