

Cutting tools

Catalogue | 21 edition

Архангельск (8182)63-90-72
Астана (7172)727-132
Астрахань (8512)99-46-04
Барнаул (3852)73-04-60
Белгород (4722)40-23-64
Брянск (4832)59-03-52
Владивосток (423)249-28-31
Волгоград (844)278-03-48
Вологда (8172)26-41-59
Воронеж (473)204-51-73
Екатеринбург (343)384-55-89
Иваново (4932)77-34-06

Ижевск (3412)26-03-58
Иркутск (395)279-98-46
Казань (843)206-01-48
Калининград (4012)72-03-81
Калуга (4842)92-23-67
Кемерово (3842)65-04-62
Киров (8332)68-02-04
Краснодар (861)203-40-90
Красноярск (391)204-63-61
Курск (4712)77-13-04
Липецк (4742)52-20-81

Магнитогорск (3519)55-03-13
Москва (495)268-04-70
Мурманск (8152)59-64-93
Набережные Челны (8552)20-53-41
Нижний Новгород (831)429-08-12
Новокузнецк (3843)20-46-81
Новосибирск (383)227-86-73
Омск (3812)21-46-40
Орел (4862)44-53-42
Оренбург (3532)37-68-04
Пенза (8412)22-31-16

Пермь (342)205-81-47
Ростов-на-Дону (863)308-18-15
Рязань (4912)46-61-64
Самара (846)206-03-16
Санкт-Петербург (812)309-46-40
Саратов (845)249-38-78
Севастополь (8692)22-31-93
Симферополь (3652)67-13-56
Смоленск (4812)29-41-54
Сочи (862)225-72-31
Ставрополь (8652)20-65-13

Сургут (3462)77-98-35
Тверь (4822)63-31-35
Томск (3822)98-41-53
Тула (4872)74-02-29
Тюмень (3452)66-21-18
Ульяновск (8422)24-23-59
Уфа (347)229-48-12
Хабаровск (4212)92-98-04
Челябинск (351)202-03-61
Череповец (8202)49-02-64
Ярославль (4852)69-52-93

Киргизия (996)312-96-26-47

Россия (495)268-04-70

Казахстан (772)734-952-31

TECHNICAL INFORMATION

Groups of high performance tools and their application:

- MASTER** Linia **MASTER TAP**, **MASTER MILL** and **MASTER DRILL** are characterized by highest performance. These tools are manufactured using state-of-art technology and materials. They can be used in a wide range of materials.

- X** Linia The **BOOX** Taps, **X-MILL** Mills and **X-DRILL** Drill Bits contain the highest number of tool variants to suit almost any application. Multifunctional tools for use on both conventional machine tools and modern CNC machines.

- 800** For structural, free machining and low alloy steels with the tensile strength of $R_m \leq 800$ Mpa.

- FAN-200** For tool and difficult to process steels with the tensile strength of $800 \text{ MPa} \leq R_m \leq 1200 \text{ MPa}$, and for heat treated steels up to 38 HRC.

- 1400-HT** For machining hard and abrasive materials such as steel with tensile strength from 1200 to 1400 Mpa and aluminum with high silicon content.

- INOX** For high alloy steel, stainless and acid resistant steels with a tensile strength of $R_m \leq 1000$ Mpa.

- GG** For processing of grey and nodular cast iron.

- GAL** For cast aluminum alloys with the Si content of max 12%.

- AL** For aluminum alloys and non ferrous metals.

- HRC** For materials, which have been hardened. The number next to the symbol indicates the maximum hardness of the material to be processed, in the HRC scale.

- S-NC** For synchronized tapping on CNC machines with the "rigid tapping" function for a wide range of materials with the high cutting speeds.

- Ms** For brass and short chip bronze.

- WGN** Forming taps for machining materials with limited ductility.



For more information visit our website WWW.FANAR.PL

- Annealed A
- Tempered QT
- Hardened and tempered HT
- Precipitation hardened PH

	Mark	Price	Availability	Cutting speed Vc (m/min)		Hole type
In catalogue	●	in pricelist	on stock	10-15	Recommended tool	Through
	○	in pricelist	on request			
	-	-	not available	10-15	Permitted use of the tool	Blind
Not in catalogue	standard index special index	on request	on request		Manual processing	

Coating

HL TiAIN + WC/C	TC TiN + TiCN	TB TiB ₂
TN2 TiAIN + TiN	AT AlTiN	TS TiAlSiN

Flutes execution

C		Straight flutes
B		Straight flutes with spiral point
R		Right spiral flutes
L		Left spiral flutes

Coolant

E Emulsion	O Oil	P Threading paste	MQL Minimum Quantity Lubrication
-------------------	--------------	--------------------------	---

The speed values below are approximate. The speed should be adjust experimentally.

			Rm	HB	HRC	kc	MATERIAL EXAMPLE	MATERIAL NUMBER	TYPE OF CHIPS		
P	Non-alloyed steel	P1	A	750	220	-	2500	11SMnPb30 / 10SPb20 / 35S20 / 11SMn37	1.0718 / 1.0722 / 1.0726 / 1.0736	short	P1
		P2	A	650	190	-	2500	S235JR / S275JR / C22 / C45	1.0038 / 1.0044 / 1.0402 / 1.0503	long	P2
		P3	A	650	190	-	2500	C55 / C60 / C60E	1.0535 / 1.0601 / 1.1221	long	P3
		P4	QT	700	210	-	2500	C25E / C53G / G18Mo5 / 16Mo5	1.1158 / 1.1213 / 1.5422 / 1.5423	long	P4
		P5	QT	1000	300	32	2600	C55 / C55E / C60E	1.0535 / 1.1203 / 1.1221	long	P5
	Low-alloyed steel	P6	A	600	175	-	2300	36Mn5 / 107CrV3 / 100Cr6 / 20NiCrMo2-2 / 41Cr4	1.1167 / 1.2210 / 1.3505 / 1.6523 / 1.7035	long	P6
		P7	QT	1000	300	32	2600	34Cr4 / 25CrMo4 / 42CrMo4 / Weldox 700 / Weldox 900	1.7033 / 1.7218 / 1.7225	long	P7
		P8	QT	1200	380	41	3000	36NiCr6 / 34CrNiMo6 / 55Cr3 / 51CrV4	1.5710 / 1.6582 / 1.7176 / 1.8159	long	P8
		P9	QT	1400	420	45	3600	55Si7 / 60SiCr7 / 55NiCrMoV6 / 40CrMoV13-9	1.0904 / 1.0961 / 1.2713 / 1.8523	long	P9
		P10	A	700	210	-	2500	X210Cr12 / X100CrMoV5-1 / HS6-5-2-5 / HS6-5-2	1.2080 / 1.2363 / 1.3243 / 1.3343	middle	P10
	High-alloyed steel and high-alloyed tool steel	P11	A	1000	300	32	2600	HS6-5-2-5 / HS18-1-2-5 / HS 10-2-5-8 / HS 6-5-3-8	1.3243 / 1.3255 / 1.3253 / 1.3294	middle	P11
		P12	HT	1400	420	45	3600	X30WCrV9-3	1.2581	middle	P12
		P13	A	700	210	-	3200	X6Cr13 / X12Cr13 / X14CrMoS17 / X6CrMo17-1	1.4000 / 1.4006 / 1.4104 / 1.4113	long	P13
		P14	QT	1100	330	34	3200	X12Cr13 / GX20Cr14 / X19CrNi17-2 / X45CrSi9-3-1	1.4006 / 1.4027 / 1.4057 / 1.4718	long	P14
M	Stainless steel	M1		700	210	-	3200	X5CrNi18-10 / X5CrNiMo17-12-2 / X2CrNiMo18-14-3 / X12NiCrSi36-16	1.4301 / 1.4401 / 1.4435,1.4864	long	M1
		M2	PH	1000	300	32	3200	X9CrNi18-8 / X53CrMnNiN21-9	1.4310 / 1.4871	long	M2
		M3		800	240	23	4000	X2CrNiN23-4 / X2CrNiMoN17-13-3 / X2CrNiMoN22-5-3 / X2CrNiMoCuN25-6-3	1.4362 / 1.4429 / 1.4462 / 1.4507	long	M3
K	Cast iron	K1		400	120	-	1600	EN-GJL-100 / EN-GJL-200 / EN-GJL-300 / EN-GJL-400	0.6010 / 0.6020 / 0.6030 / 0.6040	very short	K1
		K2		550	160	-	2500	EN-GJV-300 / EN-GJV-400 / EN-GJV-500 / EN-GJV-550	-	short/middle	K2
		K3		500	150	-	2700	EN-GJMW-300-26 / EN-GJMB-350-10 / EN-GJMB-450-6	0.8035 / 0.8135 / 0.8145	short/middle	K3
		K4		800	240	-	2700	EN-GJMB-550-4 / EN-GJMB-700-2 / EN-GJMB-800-1	0.8155 / 0.8170 / 0.8180	short/middle	K4
		K5		700	210	-	2400	EN-GJS-400-15 / EN-GJS-500-7 / EN-GJS-700-2	0.7040 / 0.7050 / 0.7070	short/middle	K5
		K6		1400	420	45	3600	EN-GJS-800-8 / EN-GJS-1200-2 / EN-GJS-1400-1	-	short/middle	K6
N	Non-ferrous metals	N1		200	-	-	680	ENAW-Al99.5 / ENAW-AlSi1MgMn (PA4) / ENAW-AlMg0.7Si (PA38) / ENAW-AlMg3 (PA11)	3.0255 / 3.2315 / 3.3206 / 3.3535	long	N1
		N2	PH	500	152	-	680	ENAW-AlCu6BiPb / ENAW-AlCu4MgSi(A) (PA6) / ENAW-AlZn5.5MgCu (Pa9) / ENAW-AlMg4.5Mn0.7 (PA13)	3.1655 / 3.1325 / 3.4365 / 3.3547	long	N2
		N3		250	75	-	680	ENAC-AlSi12 / ENAC-AlSi12(Fe) / ENAC-AlSi12(Cu) / ENAC-AlMg5	3.2581 / 3.2582 / 3.2583 / 3.3561	short/middle	N3
		N4	PH	300	90	-	680	ENAC-AlCu4MgTi / ENAC-AlSi7Mg0.3 / ENAC-AlSi9Mg / ENAC-AlSi10Mg(a)	3.1371 / 3.2371 / 3.2373 / 3.2381	short/middle	N4
		N5		450	130	-	680	ENAC-AlSi17Cu4Mg	-	short	N5
		N6		250	70	-	750	EN-MAMgMn1 / EN-MCMgRE3Zn2Zr / EN-MCMgRE2Ag2Zr / EN-MCMgAl4Si	3.5101 / 3.5103 / 3.3506 / 3.5470	short	N6
		N7		350	100	-	1100	Cu-OF / Cu-DHP / CuZn35Mn2Al1Fe1-C / CuAl10Ni5Fe4	2.0040 / 2.0090 / 2.0592 / 2.0966	extra long	N7
		N8		600	180	-	1900	CuZn37 (M63) / CuAl10Ni5Fe4 / CuSn8P	2.0321 / 2.0966 / 2.1030	long	N8
		N9		400	120	-	1900	CuZn40Pb2 (M58)(MO58) / CuSn7Zn4Pb7-C / CuSn5Zn5Pb5-C / CuSn10Pb10-C	2.0402 / 2.1090 / 2.1096 / 2.1176	short	N9
		N10		1000	300	32	1400	AMPCO 8 / AMPCO 21 / AMPCO M4	-	long	N10
S	Superalloys and titanium	S1	A	675	200	-	4000	Incoloy 909 / Multimet 155 / X10NiCrAlTi3220 (Incoly 800) / X40CoCrNi2020	1.4876 / 1.4977	long	S1
		S2	PH	950	280	29	4000	Incoloy A-286 / Unitemp 212	-	long	S2
		S3	A	850	250	25	4000	Incoloy 864 / Nimocast 713	-	long	S3
		S4	PH	1200	350	38	4000	Inconel 718 / Nimonic 80A	-	long	S4
		S5	C	1100	320	34	4000	GMR 235* / Jessop G81*	-	long	S5
		S6		675	200	-	4000	Ti 99.8 / TiCu2	3.7025 / 3.7124	extra long	S6
		S7		1250	375	40	4000	Ti-6Al-4V / Ti-6Al-2Mo-2Cr / Ti-6Al-6Mo-4Zr-2Sn	3.7165	short/middle	S7
		S8		1400	410	44	4000	Ti-10V-2Fe-3Al / Ti-13V-11Cr-3Al	-	short/middle	S8
H	Hard materials	H1	HT			50	4100	Weldox 1100 / Weldox 1300 / Hardox 500	-	short	H1
		H2	HT			55	4700	Hardox 550 / Hardox 600 / Armox 600 T	-	short	H2
		H3	HT			60	5000	Hardox Extreme	-	short	H3
		H4	HT			55	4700	GX260NiCr42 / GX330NiCr42 / GX300CrMoNi15-2-1	0.9620 / 0.9625 / 0.9640	short	H4

MASTER TAP						800X			800			FAN-I200		Name
B-HL	B-IKR-HL	C-R45-HL	C-R45-IK-HL	E-R45-HL	E-R45-IK-HL	C-TN2	B-TN2	C-R40-TN2	C	B	C-R40	B-TS	C-R40-TS	
17 / 18 40 / 41	17 / 18 40 / 41	17 / 18 40 / 41	17 / 18 40 / 41	17 / 18 40 / 41	17 / 18 40 / 41	19 / 20 42 / 43 / 44	19 / 20 / 23 42 / 43 / 44	21 / 22 / 23 42 / 43 / 44	24 / 25 45 / 46 / 47	24 / 25 / 28 45 / 46 / 47	26 / 27 / 28 45 / 46 / 47	29 48 / 49	29 48 / 49	M
63		63					64	64		65	65			UNC
67		67					68	68		69	69			UNF
							71	71		72	72			UNEF
														UNJC
														UNJF
75		75				76	76	76	77	77	77			G
									81					Rp
									81					RC
									82					NPT
									83					NPTF
									84					NPSF
										85	85			BSW
														BSF
86				86										EG M
87				87										EG UNC
88				88										EG UNF
														Tr
HSSE-PM	HSSE-PM	HSSE-PM	HSSE-PM	HSSE-PM	HSSE-PM	HSSE	HSSE	HSSE	HSSE	HSSE	HSSE	HSSE-PM	HSSE-PM	Material
B/4-5P	B/4-5P	C/2-3P	C/2-3P	E/1,5-2P	E/1,5-2P	C/2-3P	B/4-5P	C/2-3P	C/2-3P	B/4-5P	C/2-3P	B/4-5P	C/2-3P	Chamfer
														Hole type
< 3xD	< 3xD	< 2,5xD	< 2,5xD	< 2,5xD	< 2,5xD	< 1,5xD	< 3xD	< 2,5xD	< 1,5xD	< 3xD	< 2,5xD	< 3xD	< 2,5xD	Coolant
E/O/P	E/O/MQL	E/O/P	E/O/MQL	E/O/P	E/O/MQL	E/O/P	E/O/P	E/O/P	E/O/P	E/O/P	E/O/P	E/O/P	E/O/P	
Vc (m/min)														
10-40	20-50	10-40	20-50	10-40	20-50	10-35	10-35	10-35	5-20	5-20	5-20	10-35	10-35	P1
10-40	20-50	10-40	20-50	10-40	20-50	10-35	10-35	10-35	5-20	5-20	5-20	10-35	10-35	P2
10-40	20-50	10-40	20-50	10-40	20-50	10-35	10-35	10-35	5-20	5-20	5-20	10-35	10-35	P3
10-40	20-50	10-40	20-50	10-40	20-50	10-35	10-35	10-35	5-20	5-20	5-20	10-35	10-35	P4
10-40	20-50	10-40	20-50	10-40	20-50	5-20	5-20	5-20				5-20	5-20	P5
10-40	20-50	10-40	20-50	10-40	20-50	10-35	10-35	10-35	5-20	5-20	5-20	10-35	10-35	P6
10-40	20-50	10-40	20-50	10-40	20-50	5-20	5-20	5-20				5-20	5-20	P7
10-40	20-50	10-40	20-50	10-40	20-50							5-20	5-20	P8
5-15 ¹⁾	5-15 ¹⁾													P9
10-40	20-50	10-40	20-50	10-40	20-50	10-35	10-35	10-35	5-20	5-20	5-20	10-35	10-35	P10
10-40	20-50	10-40	20-50	10-40	20-50							5-20	5-20	P11
5-15 ¹⁾	5-15 ¹⁾													P12
5-15	5-25	5-15	5-25	5-15	5-25	5-15	5-15	5-15				5-15	5-15	P13
5-15	5-25	5-15	5-25	5-15	5-25	5-15	5-15	5-15				5-15	5-15	P14
5-15	5-25	5-15	5-25	5-15	5-25	5-15	5-15	5-15	5-10	5-10	5-10			M1
5-15	5-25	5-15	5-25	5-15	5-25	5-15	5-15	5-15	5-10	5-10	5-10	5-10	5-10	M2
5-15	5-25	5-15	5-25	5-15	5-25	5-15	5-15	5-15	5-10	5-10	5-10	5-10	5-10	M3
10-30	10-50	10-30	10-50	10-30	10-50	5-15	5-15		5-15	5-15		5-15	5-15	K1
10-30	10-50	10-30	10-50	10-30	10-50	5-15	5-15		5-15	5-15		5-15	5-15	K2
10-30	10-50	10-30	10-50	10-30	10-50	10-25	10-25	10-25	5-15	5-15	5-15	10-25	10-25	K3
10-30	10-50	10-30	10-50	10-30	10-50	10-25	10-25	10-25	5-15	5-15	5-15	10-25	10-25	K4
10-30	10-50	10-30	10-50	10-30	10-50	10-25	10-25	10-25	5-15	5-15	5-15	10-25	10-25	K5
5-15 ¹⁾	5-15 ¹⁾	5-15 ¹⁾	5-15 ¹⁾	5-15 ¹⁾	5-15 ¹⁾				5-15	5-15	5-15	10-25	10-25	K6
10-30	10-50	10-30	10-50	10-30	10-50									N1
10-30	10-50	10-30	10-50	10-30	10-50									N2
10-30	10-50	10-30	10-50	10-30	10-50	10-30	10-30	10-20	10-25	10-25	10-25	10-30	10-30	N3
10-30	10-50	10-30	10-50	10-30	10-50	10-30	10-30	10-20	10-25	10-25	10-25	10-30	10-30	N4
10-30	10-50	10-30	10-50	10-30	10-50	10-30	10-30	10-20	5-20	5-20	10-25	10-30	10-30	N5
10-30	10-50	10-30	10-50	10-30	10-50									N6
10-30	10-50	10-30	10-50	10-30	10-50	10-30	10-30	10-30	5-20	5-20	5-20	10-30	10-30	N7
10-30	10-50	10-30	10-50	10-30	10-50	10-30	10-30	10-30	5-20	5-20	5-20	10-30	10-30	N8
10-30	10-50	10-30	10-50	10-30	10-50									N9
5-25	5-25	5-25	5-25	5-25	5-25							10-30	10-30	N10
1-8 ¹⁾	1-8 ¹⁾	1-8 ¹⁾	1-8 ¹⁾	1-8 ¹⁾	1-8 ¹⁾									S1
1-8 ¹⁾	1-8 ¹⁾	1-8 ¹⁾	1-8 ¹⁾	1-8 ¹⁾	1-8 ¹⁾									S2
														S3
														S4
														S5
1-8 ¹⁾	1-8 ¹⁾	1-8 ¹⁾	1-8 ¹⁾	1-8 ¹⁾	1-8 ¹⁾									S6
														S7
														S8
														H1
														H2
														H3
														H4

Page

P

M

K

N





















S



















































H

Name	1400-HT			INOX				GG					GAL	
	C-TS	B-TS	C-R15-TS	B	B-HL	C-R40	C-R40-HL	C-TS	C-IK-TS	E-TS	E-IK-TS	E-IKR-TS	C-R15-TS	E-R15-IK-TS
M	29	29	29	30 / 31	30 / 31	30 / 31	30 / 31	32	32	32	32	32	32	32
MF	48 / 49	48 / 49	48 / 49	50 / 51 / 52	50 / 51 / 52	50 / 51 / 52	50 / 51 / 52	53 / 54	53 / 54	53 / 54	53 / 54	53 / 54	53 / 54	53 / 54
UNC														
UNF														
UNEF														
UNJC		73	73											
UNJF		74	74											
G														
Rp														
RC														
NPT														
NPTF														
NPSF														
BSW														
BSF														
EG M														
EG UNC														
EG UNF														
Tr														
Material	HSSE-PM	HSSE-PM	HSSE-PM	HSSE	HSSE	HSSE	HSSE	HSSE-PM	HSSE-PM	HSSE-PM	HSSE-PM	HSSE-PM	HSSE-PM	HSSE-PM
Chamfer	C/2-3P	B/4-5P	C/2-3P	B/4-5P	B/4-5P	C/2-3P	C/2-3P	C/2-3P	C/2-3P	E/1,5-2P	E/1,5-2P	E/1,5-2P	C/2-3P	E/1,5-2P
Hole type														
	< 1,5xD	< 2,5xD	< 1,5xD	< 3xD	< 3xD	< 2,5xD	< 2,5xD	< 2xD	< 2,5xD	< 2xD	< 2,5xD	< 2,5xD	< 2,5xD	< 2,5xD
Coolant	E/O/P	E/O	E/O/P	E/O/P	E/O/P	E/O/P	E/O/P	E/O	E/O/MQL	E/O	E/O/MQL	E/O/MQL	E/O/P	E/O/MQL
Vc (m/min)														
P	P1													
	P2													
	P3													
	P4													
	P5	5-20	5-20	5-20										
	P6													
	P7	5-20	5-20	5-20										
	P8	5-20	5-20	5-20										
	P9	1-5	1-10	1-10										
	P10													
	P11	5-20	5-20	5-20										
	P12	1-5	1-10	1-10										
	P13													
	P14													
M	M1			5-15	5-25	5-15	5-25							
	M2	5-10	5-10	5-10	5-15	5-25	5-15	5-25						
	M3	1-8	1-8	1-8	5-10	5-10	5-10	5-10						
K	K1	10-20	10-20	10-20				20-60	20-60	20-60	20-60	20-60		
	K2							15-30	15-30	15-30	15-30	15-30		
	K3	10-20	10-20	10-20				15-30	15-30	15-30	15-30	15-30		
	K4	10-20	10-20	10-20				15-30	15-30	15-30	15-30	15-30		
	K5	10-20	10-20	10-20				15-30	15-30	15-30	15-30	15-30		
	K6	1-5	1-10	1-10				5-10	5-10	5-10	5-10	5-10		
N	N1													
	N2													
	N3			10-30									10-30	10-50
	N4			10-30									10-30	10-50
	N5			10-30									10-30	10-50
	N6													
	N7													
N8														
N9														
N10														
S	S1													
	S2													
	S3													
	S4													
	S5													
	S6													
	S7													
	S8													
H	H1													
	H2													
	H3													
	H4													

HRC60				S-NC			DIN-352	Ms	NUTAP	NGMF	NGST	KOMBI	BIT	Name
C-HM-TC	C-IK-HM-TC	D-HM-TC	D-IK-HM-TC	B-TC	C-R45-TC	C-R45-IK-TC					TRAPEZOIDAL			
33	33	33	33	34	34	34	35		36	37		38	39	M
				55 / 56	55 / 56	55 / 56	57 / 58 / 59		60	61 / 62				MF
							66							UNC
							70							UNF
														UNEF
														UNJC
							79	78		80				UNJF
														G
														Rp
														RC
														NPT
														NPTF
														NPSF
														BSW
														BSF
														EG M
														EG UNC
														EG UNF
											89			Tr
VHM	VHM	VHM	VHM	HSSE-PM	HSSE-PM	HSSE-PM	HSS	HSSE	HSSE	HSS	HSS	HSS	HSS	HSS
C/2-3P	C/2-3P	D/3,5-5P	D/3,5-5P	B/4-5P	C/2-3P	C/2-3P	~3P	F/1P	12P	12P	24P	D/4P	D/4P	
< 1,5xD	< 1,5xD	< 1,5xD	< 1,5xD	< 2,5xD	< 3xD	< 3xD	< 1,5xD	< 2xD	< 1,5xD	< 1,5xD	< 2xD	< 1,5xD	< 1,5xD	
E/O/P	E/O/MQL	E/O/P	E/O/MQL	E/O/P	E/O/P	E/O/MQL	E/O/P	E/O/P	E/O/P	E/O/P	E/O/P	E/O/P	E/O/P	E/O/P
				10-50	10-50	20-60	5-20		5-20	5-20	5-20	5-15	5-15	P1
				10-50	10-50	20-60	5-20		5-20	5-20	5-20	5-15	5-15	P2
				10-50	10-50	20-60	5-20		5-20	5-20	5-20	5-15	5-15	P3
				10-50	10-50	20-60	5-20		5-20	5-20	5-20	5-15	5-15	P4
				10-50	10-50	20-60			5-15					P5
				10-50	10-50	20-60	5-20		5-20	5-20	5-20	5-15	5-15	P6
				10-50	10-50	20-60			5-15					P7
				10-50	10-50	20-60			5-10					P8
				5-15 ¹⁾										P9
				10-50	10-50	20-60	5-20		5-20	5-20	5-20	5-15	5-15	P10
				10-50	10-50	20-60			5-15					P11
				5-15 ¹⁾										P12
				5-20	5-20	5-30								P13
				5-15	5-15	5-25								P14
				5-20	5-20	5-30								M1
				5-15	5-15	5-25								M2
				5-20	5-20	5-30								M3
				10-40	10-40	10-60				6-15	6-15			K1
				10-40	10-40	10-60								K2
				10-40	10-40	10-60								K3
				10-40	10-40	10-60								K4
				10-40	10-40	10-60								K5
				5-15 ¹⁾	5-15 ¹⁾	5-15 ¹⁾								K6
				10-40	10-40	10-60								N1
				10-40	10-40	10-60								N2
				10-40	10-40	10-60								N3
				10-40	10-40	10-60								N4
				10-40	10-40	10-60								N5
				10-40	10-40	10-60								N6
				10-40	10-40	10-60								N7
				10-40	10-40	10-60								N8
				10-40	10-40	10-60		10-25		6-15	6-15	6-15	6-15	N9
				5-25	5-25	5-30								N10
				1-8 ¹⁾	1-8 ¹⁾	1-8 ¹⁾								S1
				1-8 ¹⁾	1-8 ¹⁾	1-8 ¹⁾								S2
														S3
														S4
														S5
				1-8 ¹⁾	1-8 ¹⁾	1-8 ¹⁾								S6
														S7
														S8
	1-4	1-4	1-4	1-4										H1
	1-4	1-4	1-4	1-4										H2
	1-4	1-4	1-4	1-4										H3
	1-4	1-4	1-4	1-4										H4

Page

Name		WGN						HRC			
		C-TN2	C-SR-TN2	C-SR-TC	E-SR-TC	E-SR-IK-TC	E-SR-IKR-TC				
											
											Thread mills for small holes
M		93	93	93	93	93	93	101	102	103	104
MF			94	94				101	102	103	104
UNC			95								
UNF			96								
UNEF											
G			97								
Material		PM/HSSE	PM/HSSE	PM/HSSE	PM/HSSE	PM/HSSE	PM/HSSE	VHM	VHM	VHM	VHM
Chamfer		C/2-3P	C/2-3P	C/2-3P	E/1,5-2P	E/1,5-2P	E/1,5-2P	-	-	-	-
Hole type											
Coolant		E/O	E/O	E/O	E/O	E/O/MQL	E/O/MQL	E/O	E/O	E/O	E/O
P	P1	10-30	10-30	10-30	10-30	15-50	15-50	100-150	100-150		50-90
	P2	10-30	10-30	10-30	10-30	15-50	15-50	100-150	100-150		50-90
	P3	10-30	10-30	10-30	10-30	15-50	15-50	100-150	100-150		50-90
	P4	10-30	10-30	10-30	10-30	15-50	15-50	100-150	100-150		50-90
	P5	10-25	10-25	10-25	10-25	10-30	10-30	100-150	100-150		45-60
	P6	10-30	10-30	10-30	10-30	15-50	15-50	85-120	85-120		50-90
	P7	10-25	10-25	10-25	10-25	10-30	10-30	85-120	85-120		45-60
	P8							85-120	85-120		40-55
	P9							85-120	85-120		40-55
	P10	10-30	10-30	10-30	10-30	15-50	15-50	70-100	70-100	70-100	50-90
	P11			10-25	10-25	10-30	10-30	70-100	70-100	70-100	45-60
	P12							70-100	70-100	70-100	40-55
	P13			10-25	10-25	10-30	10-30	60-90	60-90	60-90	50-90
	P14							60-90	60-90	60-90	40-55
M	M1	10-25	10-25	10-25	10-25	10-25	10-25	60-90	60-90	60-90	35-50
	M2	10-25	10-25	10-25	10-25	10-25	10-25	60-90	60-90	60-90	35-50
	M3			10-25	10-25	10-25	10-25	50-70	50-70	50-70	35-50
K	K1							70-150	70-150		40-60
	K2							70-150	70-150		40-60
	K3							70-150	70-150		40-60
	K4							70-150	70-150		40-60
	K5							70-150	70-150		40-60
	K6										40-60
N	N1	20-40	20-40	20-60	20-60	20-60	20-60	150-220	150-220		60-180
	N2	20-40	20-40	20-60	20-60	20-60	20-60	150-220	150-220		60-180
	N3	20-40	20-40	20-60	20-60	20-60	20-60	150-220	150-220		60-180
	N4			20-60	20-60	20-60	20-60	150-220	150-220		60-180
	N5			20-60	20-60	20-60	20-60	100-180	100-180		60-180
	N6							100-180	100-180		
	N7	20-40	20-40	20-60	20-60	20-60	20-60	100-180	100-180		60-180
	N8	20-40	20-40	20-60	20-60	20-60	20-60	100-180	100-180		60-180
	N9							100-180	100-180		
	N10							100-180	100-180		
S	S1									20-40	25-40
	S2									20-40	25-40
	S3									20-40	25-40
	S4									20-40	25-40
	S5									20-40	25-40
	S6									30-50	25-40
	S7									30-50	25-40
	S8									30-50	25-40
H	H1									55-70	
	H2									40-60	
	H3									35-50	
	H4										

		INOX			HRC40	Name
KPL/2	KPL/3	KPL/3-P	KPL/3-P-TN2	KPL/3-P-TS		
						
107 / 108 / 109	107 / 108 / 109	110	111	112		M
113 / 114 / 115				116		MF
	117					UNC
118						UNF
119		120		121		G
	122					BSW
123						BSF
HSS C/2-3P	HSS C/2-3P	HSSE C/2-3P	HSSE C/2-3P	HSSE-PM C/2-3P		Material
						Chamfer
< 2,5xD	< 2,5xD	< 2,5xD	< 2,5xD	< 1,5xD		Hole type
E/O/P	E/O/P	E/O/P	E/O/P	E/O/P		Coolant
						P1
						P2
						P3
						P4
						P5
						P6
						P7
						P8
						P9
						P10
						P11
						P12
						P13
						P14
						M1
						M2
						M3
						K1
						K2
						K3
						K4
						K5
						K6
						N1
						N2
						N3
						N4
						N5
						N6
						N7
						N8
						N9
						N10
						S1
						S2
						S3
						S4
						S5
						S6
						S7
						S8
						H1
						H2
						H3
						H4

Page

P





M

K

N

S

H

Name	800	800 SPN	Ms	INOX
				
M	127	127	127	127
MF	128 / 129 / 130	128 / 129 / 130	128 / 129 / 130	128 / 129 / 130
UNC	131			
UNF	132			
G	133	133	133	133
R	134			
BSW	135			
BSF	136			
NPT	137			
Execution		SPN - spiral point	Lapped; special geometry	Lapped; special geometry
Material	HSS	HSS	HSS	HSSE
Chamfer	1,75P	1,75P	1,25P	2,25P
Coolant	E/O/P	E/O/P	E/O/P	E/O/P
P	P1	4-8		4-8
	P2	3-6	3-6	3-6
	P3	3-6	3-6	3-6
	P4	2-5	2-5	3-6
	P5	2-5	2-5	3-6
	P6			
	P7			
	P8			
	P9			
	P10	1-3	1-3	1-5
	P11			1-5
	P12			
	P13			2-6
	P14			2-6
M	M1			2-6
	M2			2-6
	M3			
K	K1		5-8	
	K2		5-8	
	K3		5-8	
	K4		2-5	
	K5		2-5	
	K6			
N	N1			
	N2			
	N3	10-20	10-20	10-20
	N4	10-20	10-20	10-20
	N5			5-15
	N6			1-5
	N7	7-12	7-12	10-15
	N8	10-15	10-15	10-15
	N9			20-30
	N10			6-10
S	S1			
	S2			
	S3			
	S4			
	S5			
	S6			
	S7			
	S8			
H	H1			
	H2			
	H3			
	H4			

MASTERDRILL			X-DRILL				HRC		AL		INOX		
DIN-6537 3xD	DIN-6537 5xD	DIN-6537 8xD	DIN-6537 3xD	DIN-6537 5xD	DIN-6537	DIN-6539	DIN-6537 3xD	DIN-6537 5xD	DIN-6537 5xD	DIN-6537 5xD	DIN-338	DIN-338	Norm
m7	m7	m7	m7	m7	m7	h7	m7	m7	m7	m7	h8	h8	Tolerance
141 - 143	144 - 146	147 - 149	141 - 143	144 - 146	160 - 161	159	150 - 152	153 - 155	156 - 158	156 - 158	162 - 164	162 - 164	Page number
$\lambda 35^{\circ} \pm 40^{\circ}$ $\delta 140^{\circ}$	$\lambda 35^{\circ} \pm 40^{\circ}$ $\delta 140^{\circ}$	$\lambda 35^{\circ} \pm 40^{\circ}$ $\delta 140^{\circ}$	$\lambda 35^{\circ} \pm 40^{\circ}$ $\delta 140^{\circ}$	$\lambda 35^{\circ} \pm 40^{\circ}$ $\delta 140^{\circ}$	$\lambda 35^{\circ} \pm 40^{\circ}$ $\delta 140^{\circ}$	$\lambda 35^{\circ} \pm 40^{\circ}$ $\delta 118^{\circ}$	$\lambda 35^{\circ} \pm 40^{\circ}$ $\delta 140^{\circ}$	$\lambda 35^{\circ} \pm 40^{\circ}$ $\delta 140^{\circ}$	$\lambda 15^{\circ}$ $\delta 130^{\circ}$	$\lambda 15^{\circ}$ $\delta 130^{\circ}$	$\lambda 36^{\circ}$ $\delta 130^{\circ}$	$\lambda 36^{\circ}$ $\delta 130^{\circ}$	Geometry
IK	IK	IK					IK	IK	IK	IK			External coolant
VHM	VHM	VHM	VHM	VHM	VHM	VHM	VHM	VHM	VHM	VHM	HSSE	HSSE	Material
AT	AT	AT	AT	AT	AT		TS	TS			TB	TN2	Coating
3+20	3+20	3+20	3+20	3+20	2,35+14	0,75+2,9	3+20	3+20	3+20	3+20	1+16	1+16	Range of diameter
110 c	100 c	50 c	70 c	60 c	70 a	55 a					35 c	40 c	P1
110 c	100 c	50 c	70 c	60 c	70 a	55 a					28 b	32 b	P2
100 c	90 c	50 c	70 c	60 c	70 a	55 a					28 b	32 b	P3
110 c	100 c	40 b	50 b	45 b	50 a	40 a					18 b	21 b	P4
100 c	90 c	40 b	50 b	45 b	50 a	40 a					18 b	21 b	P5
95 c	85 c	40 b	50 b	45 b	50 a	40 a					18 b	21 b	P6
85 c	75 c	30 b	40 b	35 b	40 a	30 a							P7
65 c	55 c	30 b	40 b	35 b	40 a	30 a							P8
65 c	55 c	25 b	30 b	30 b	30 a	25 a							P9
60 c	50 c	40 b	50 b	45 b	50 a	40 a					18 b	21 b	P10
55 c	45 c	30 b	40 b	35 b	40 a	30 a							P11
55 c	45 c	25 b	30 b	30 b	30 a	25 a							P12
60 c	50 c	40 b	50 b	45 b	50 a	40 a					13 b	15 b	P13
60 c	50 c	40 b	50 b	45 b	50 a	40 a					13 b	15 b	P14
60 b	50 b	25 b	30 b	30 b	30 a	25 a					10 b	12 b	M1
60 b	50 b												M2
60 b	50 b	25 b	30 b	30 b	30 a	25 a							M3
120 d	110 d	80 d	100 d	90 d	100 b	80 b					35 d	40 d	K1
95 d	85 d												K2
120 d	110 d	60 d	80 d	70 d	80 b	60 b							K3
100 d	90 d	60 d	80 d	70 d	80 b	60 b							K4
85 d	75 d	50 d	65 d	60 d	65 b	50 b							K5
85 d	75 d	50 d	65 d	60 d	65 b	50 b							K6
250 e	220 e	160 e	200 e	180 e	200 b	160 b			250 e	250 e	37 d	43 d	N1
250 e	220 e	160 e	200 e	180 e	200 b	160 b			250 e	250 e	37 d	43 d	N2
250 e	220 e	160 e	200 e	180 e	200 b	160 b			250 e	250 e	27 c	31 c	N3
250 e	220 e	160 e	200 e	180 e	200 b	160 b			250 e	250 e	27 c	31 c	N4
200 e	180 e	130 e	160 e	150 e	160 a	125 a			200 e	200 e	32 d	37 d	N5
200 e	180 e								150 d	150 d			N6
120 c	110 d	80 c	100 c	90 c	100 b	80 b			200 c	200 c	38 c	44 c	N7
150 c	135 c	100 c	120 c	110 c	120 b	100 b			200 c	200 c	41 b	47 b	N8
150 c	135 c	100 c	120 c	110 c	120 b	100 b			200 c	200 c	41 b	47 b	N9
150 c	135 c								200 c	200 c			N10
25 a	22 a	15 a	20 a	18 a	20 a	16 a					9 b	10 b	S1
25 a	22 a	15 a	20 a	18 a	20 a	16 a					9 b	10 b	S2
25 a	22 a												S3
25 a	22 a												S4
25 a	22 a												S5
60 b	50 b	30 b	40 b	35 b	40 a	30 a					24 b	28 b	S6
60 b	50 b	25 b	30 b	30 b	30 a	25 a					12 a	14 a	S7
60 b	50 b	25 b	30 b	30 b	30 a	25 a					12 a	14 a	S8
							40 b	40 b					H1
							35 b	35 b					H2
							30 b	30 b					H3
							35 b	35 b					H4

The table contains recommended cutting speeds Vc in m/min and the symbols of feed groups on next page























	WST	WDG	Center drills			Deburring tools		Countersinks				Taper reamers
									Deburring tool PF	with solid pilot		
												
Norm			NC	NC	DIN-333 A / B / R / EL	DIN-6537L	DIN-6537L	DIN-335	DIN-335		DIN-373	
Tolerance												
Page number	165	166	167	167	168 - 171	172	172	174	174	176	177	178
Geometry			δ90°	δ120°		δ60°	δ90°	δ90°	δ90°	δ30 / 45 / 60°		
External coolant												
Material	HSS	VHM	HSSE	HSSE	HSSE / HSS / VHM	VHM	VHM	HSSE	VHM		HSS	HSS
Coating	- / TN2	AT	TN2	TN2	TN2 / AT	AT	AT	- / TN2 / TC	AT	-	-	-
Range of diameter		2,5+10,2	3+16	2,5+10,2	0,8+10	4+20	4+20					

TABLE OF RECOMMENDED FEED MM/REV FOR DRILLS

Group	Drill diameter											
	Ø 1	Ø 2	Ø 3	Ø 4	Ø 5	Ø 6	Ø 8	Ø 10	Ø 12	Ø 14	Ø 16	Ø 20
a	0,015	0,030	0,038	0,047	0,053	0,060	0,075	0,090	0,100	0,120	0,127	0,160
b	0,020	0,050	0,070	0,085	0,100	0,120	0,150	0,180	0,200	0,230	0,250	0,270
c	0,023	0,080	0,100	0,130	0,150	0,180	0,250	0,270	0,280	0,300	0,330	0,370
d	0,030	0,100	0,160	0,180	0,220	0,240	0,300	0,370	0,400	0,450	0,480	0,500
e	0,035	0,120	0,200	0,250	0,270	0,300	0,350	0,450	0,470	0,500	0,530	0,550
f	0,050	0,150	0,220	0,250	0,320	0,400	0,490	0,620	0,650	0,720	0,850	0,900
g	0,070	0,160	0,250	0,270	0,360	0,470	0,620	0,830	0,900	0,950	1,100	1,200
h	0,090	0,200	0,270	0,300	0,400	0,520	0,750	1,000	1,100	1,200	1,300	1,350

The symbols of feed groups are given in the drills selection table by the recommended cutting speed

MASTERMILL				X-MILL									
440N	R440N	B440N	645	230	230L	B230	B230L	345	R345	440S	R440S		
Z=4	Z=4	Z=4	Z=6	Z=2	Z=2	Z=2	Z=2	Z=3	Z=3	Z=4	Z=4	Number of flutes	
VHM	VHM	VHM	VHM	VHM	VHM	VHM	VHM	VHM	VHM	VHM	VHM	Tool material	
TS	TS	TS	TS	AT	AT	AT	AT	AT	AT	AT	AT	Coating	
												Corner type	
181	181	182	183	184	185	186	187	188	188	189	189	Page	
•	•	•	•	•	•	•	•	•	•	•	•	P1	
•	•	•	•	•	•	•	•	•	•	•	•	P2	
•	•	•	•	•	•	•	•	•	•	•	•	P3	
•	•	•	•	•	•	•	•	•	•	•	•	P4	
•	•	•	•	•	•	•	•	•	•	•	•	P5	
•	•	•	•	•	•	•	•	•	•	•	•	P6	
•	•	•	•	•	•	•	•	•	•	•	•	P7	
•	•	•	•	•	•	•	•	•	•	•	•	P8	
•	•	•	•	•	•	•	•	•	•	•	•	P9	
•	•	•	•	•	•	•	•	•	•	•	•	P10	
•	•	•	•	•	•	•	•	•	•	•	•	P11	
•	•	•	•	•	•	•	•	•	•	•	•	P12	
•	•	•	•	•	•	•	•	•	•	•	•	P13	
•	•	•	•	•	•	•	•	•	•	•	•	P14	
•	•	•	•					○	○	○	○	M1	
•	•	•	•					○	○	○	○	M2	
•	•	•	•					○	○	○	○	M3	
•	•	•	•	•	•	•	•	•	•	•	•	K1	
•	•	•	•	•	•	•	•	•	•	•	•	K2	
•	•	•	•	•	•	•	•	•	•	•	•	K3	
•	•	•	•	•	•	•	•	•	•	•	•	K4	
•	•	•	•	•	•	•	•	•	•	•	•	K5	
•	•	•	•	•	•	•	•	•	•	•	•	K6	
○	○	○	○					○	○	○	○	N1	
○	○	○	○					○	○	○	○	N2	
○	○	○	○					○	○	○	○	N3	
○	○	○	○					○	○	○	○	N4	
○	○	○	○					○	○	○	○	N5	
○	○	○	○	○	○	○	○	○	○	○	○	N6	
○	○	○	○	○	○	○	○	○	○	○	○	N7	
○	○	○	○	○	○	○	○	○	○	○	○	N8	
○	○	○	○	○	○	○	○	○	○	○	○	N9	
○	○	○	○	○	○	○	○	○	○	○	○	N10	
•	•	•	•					○	○	○	○	S1	
•	•	•	•					○	○	○	○	S2	
•	•	•	•					○	○	○	○	S3	
•	•	•	•					○	○	○	○	S4	
•	•	•	•					○	○	○	○	S5	
•	•	•	•					○	○	○	○	S6	
•	•	•	•					○	○	○	○	S7	
•	•	•	•					○	○	○	○	S8	
○	○	○	○									H1	
												H2	
												H3	
												H4	

		X-MILL									ZGR	
		440N	R440N	440NL	R440NL	430L	R430L	B440	540	R540	420	540N
												
Number of flutes		Z=4	Z=4	Z=4	Z=4	Z=4	Z=4	Z=4	Z=5	Z=6	Z=3-4	Z=4-6
Tool material		VHM	VHM	VHM	VHM	VHM	VHM	VHM	VHM	VHM	VHM	VHM
Coating		AT	AT	AT	AT	AT	AT	AT	AT	AT	AT	TS
Corner type												
Page		190 - 191	190 - 191	192	192	193	193	194	195	195	196	197
P	P1	●	●	●	●	●	●	●	●	●	●	●
	P2	●	●	●	●	●	●	●	●	●	●	●
	P3	●	●	●	●	●	●	●	●	●	●	●
	P4	●	●	●	●	●	●	●	●	●	●	●
	P5	●	●	●	●	●	●	●	●	●	●	●
	P6	●	●	●	●	●	●	●	●	●	●	●
	P7	●	●	●	●	●	●	●	●	●	●	●
	P8	●	●	●	●	●	●	●	●	●	●	●
	P9	●	●	●	●	●	●	●	●	●	●	●
	P10	●	●	●	●	●	●	●	●	●	●	●
	P11	●	●	●	●	●	●	●	●	●	●	●
	P12	●	●	●	●	●	●	●	●	●	●	●
	P13	●	●	●	●	●	●	●	●	●	●	●
	P14	●	●	●	●	●	●	●	●	●	●	●
M	M1	○	○	○	○			○	○	○	○	○
	M2	○	○	○	○			○	○	○	○	○
	M3	○	○	○	○			○	○	○	○	○
K	K1	●	●	●	●	●	●	●	●	●	○	○
	K2	●	●	●	●	●	●	●	●	●	○	○
	K3	●	●	●	●	●	●	●	●	●	○	○
	K4	●	●	●	●	●	●	●	●	●	○	○
	K5	●	●	●	●	●	●	●	●	●	○	○
	K6	●	●	●	●	●	●	●	●	●	○	○
N	N1	○	○	○	○			○	○	○		
	N2	○	○	○	○			○	○	○		
	N3	○	○	○	○			○	○	○		
	N4	○	○	○	○			○	○	○		
	N5	○	○	○	○			○	○	○		
	N6											
	N7	○	○	○	○	○	○	○	○	○		
	N8	○	○	○	○	○	○	○	○	○		
	N9	○	○	○	○	○	○	○	○	○		
	N10	○	○	○	○	○	○	○	○	○		
S	S1	○	○	○	○			○	○	○		
	S2	○	○	○	○			○	○	○		
	S3	○	○	○	○			○	○	○		
	S4	○	○	○	○			○	○	○		
	S5	○	○	○	○			○	○	○		
	S6	○	○	○	○			○	○	○		
	S7	○	○	○	○			○	○	○		
	S8	○	○	○	○			○	○	○		
H	H1										●	●
	H2										○	○
	H3											
	H4										○	○

HRC			AL										MultiCUT					
HFM 200	B415N	R645	130	245	R245	B245	345	R345	345NL	B345NL	445	R338		Conical				
Z=2	Z=4	Z=6	Z=1	Z=2	Z=2	Z=2	Z=3	Z=3	Z=3	Z=3	Z=4	Z=3	Z=2	Z=4	Number of flutes			
VHM	VHM	VHM	VHM	VHM	VHM	VHM	VHM	VHM	VHM	VHM	VHM	VHM	VHM	VHM	Tool material			
AD	TS	TS	PVD	PVD	TB	PVD	TB	TB	PVD	TB	PVD	TB	TB	PVD	TB	AT	TS	Coating
															Corner type			
198	199	200	201	202 - 203	202 - 203	204	205 - 208	205 - 208	209	210	211	212	213	214	Page			
○													●	●	P1			
○													●	●	P2			
○													●	●	P3			
○													●	●	P4			
●													●	●	P5			
○													●	●	P6			
●													●	●	P7			
●													●	●	P8			
○													●	●	P9			
●													●	●	P10			
●													●	●	P11			
●													●	●	P12			
○													●	●	P13			
●													●	●	P14			
													●	○	M1			
													●	○	M2			
													●	○	M3			
●													●	●	K1			
●													●	●	K2			
●													●	●	K3			
●													●	●	K4			
●													●	●	K5			
●													●	●	K6			
			●	●	●	●	●	●	●	●	●	●	●	○	N1			
			●	●	●	●	●	●	●	●	●	●	●	○	N2			
			●	●	●	●	●	●	●	●	●	●	●	○	N3			
			●	●	●	●	●	●	●	●	●	●	●	○	N4			
			●	●	●	●	●	●	●	●	●	●	●	○	N5			
			●	●	●	●	●	●	●	●	●	●	●	○	N6			
			●	●	●	●	●	●	●	●	●	●	●	○	N7			
			●	●	●	●	●	●	●	●	●	●	●	○	N8			
			●	●	●	●	●	●	●	●	●	●	●	○	N9			
			●	●	●	●	●	●	●	●	●	●	●	○	N10			
													○	○	S1			
													○	○	S2			
													○	○	S3			
													○	○	S4			
													○	○	S5			
													○	○	S6			
													○	○	S7			
													○	○	S8			
●	●	●													H1			
○	●	●													H2			
	●	●													H3			
○	●	●													H4			

MASTER TAP						BOOX				BOO		FAN-I200		Name
B-HL	B-WR-HL	C-R45-HL	C-R45-KHL	E-R45-HL	E-R45-KHL	C-TN	B-TN	C-R45-TN	C	B	C-R40	B-TC	C-R40-TC	
15/16	15/16	15/16	15/16	15/16	15/16	17/18	17/18	17/18	19/20	18/20/22	21/22/23	24	24	M
35/38	35/38	35/38	35/38	35/38	35/38	37/39	37/39	37/39	38/41	37/41	38/41	42/44	42/44	M
62	62	62	62	62	62	69	69	69	69	69	69	69	69	M
80	80	80	80	80	80	86	86	86	86	86	86	86	86	M
81	81	81	81	81	81	89	89	89	89	89	89	89	89	M

1 Workpiece material

Symbol	Material Name	Material Description
P	Stal	Stal automatowa C 0,05 % wyważona C 0,05 % wyważona C 0,05 % utęszczona całością C 0,05 % utęszczona całością
M	Stal nierdzewna	Austenityczna Austenityczna Dupleks
K	Zelazo	Zelazo szare (S.G.) Zelazo węglikowe (G.WV) CGE Zelazo węglikowe (G.WV) GJMB Zelazo ciekłe (GJMB) Zelazo sztywne (GJMB) Zelazo sztywne (GJMB) ACP
N	Metalie nieżelazne	Stopy aluminium o obróbki plastycznej Stopy aluminium odlewane Stopy magnezu Miedź i jej stopy Stopy żaroodporne i stopy tytanu
S	Materiały twarde	Na bazie Fe Na bazie NiCo Czysty tytan Stopy α-β Stopy β
H	Stal hartowana	Zelazo utęszczona i hartowana

5 Thread size

Gwint metryczny DIN-13

M	P	l1	l2	l3	Ø d1	Ø d2	a	INDEX
M1	0,25	40	6	-	2,5	2,1	0,75	0010
M1,1	0,25	40	6	-	2,5	2,1	0,85	0011
M1,2	0,25	40	6	-	2,5	2,1	0,95	0012
M1,4	0,30	40	7	-	2,5	2,1	1,10	0014

M	P	l1	l2	l3	Ø d1	Ø d2	a	INDEX
M1,6	0,35	40	8	-	2,5	2,1	1,25	0016
M1,7	0,35	40	8	-	2,5	2,1	1,35	0017
M1,8	0,35	40	8	-	2,5	2,1	1,45	0018
M2	0,40	45	10	-	2,8	2,1	1,60	0020
M2,2	0,45	45	10	-	2,8	2,1	1,75	0022
M2,3	0,40	45	10	-	2,8	2,1	1,90	0023
M2,5	0,45	50	9	-	2,8	2,1	2,05	0025
M2,6	0,45	50	9	-	2,8	2,1	2,15	0026

M	P	l1	l2	l3	Ø d1	Ø d2	a	INDEX
M3	0,50	56	10	-	3,5	2,7	2,50	0030
M3,5	0,60	56	12	-	4,0	3,0	2,90	0035
M4	0,70	63	12	-	4,5	3,4	3,30	0040
M4,5	0,75	70	14	-	5,0	3,8	3,80	0045
M5	0,80	70	14	-	5,0	4,2	4,20	0050
M6	1,00	80	18	-	6,0	4,9	5,00	0060
M7	1,00	80	18	-	7,0	5,5	6,00	0070
M8	1,25	90	20	-	8,0	6,2	6,80	0080
M9	1,25	90	20	-	9,0	7,0	7,80	0090
M10	1,50	100	20	-	10,0	8,0	8,50	0100

4 Tool execution

M	P	l1	l2	l3	Ø d1	Ø d2	a	INDEX
M4,5	0,75	70	14	-	5,0	4,9	3,80	0045
M5	0,80	70	14	-	5,0	4,9	4,20	0050
M6	1,00	80	18	-	6,0	4,9	5,00	0060
M7	1,00	80	18	-	7,0	5,5	6,00	0070
M8	1,25	90	20	-	8,0	6,2	6,80	0080
M9	1,25	90	20	-	9,0	7,0	7,80	0090
M10	1,50	100	20	-	10,0	8,0	8,50	0100

7 Cutting speed

HOW TO SELECT THE PRODUCT?

1. In the selection table locate the workpiece material
2. Select execution of tool
3. Find the page number in the catalog for the selected type of thread
4. Find the tool execution on specified page
5. Select the correct thread size
6. Make an index and name e.g. C2-221101-0080 Tap 800 M8-6H DIN-371 C LH HSSE
7. Read recommended cutting data

CONTENTS

Page		
15 - 90	HIGH PERFORMANCE MACHINE TAPS	1
91 - 98	FORMING TAPS	2
99 - 104	THREAD MILLS	3
105 - 124	HAND TAPS	4
125 - 138	SCREWING DIES	5
139 - 178	DRILLING TOOLS	6
179 - 214	END MILLS	7
215 - 228	GAUGES	8
229 - 250	TOOLHOLDERS	9
251 - 264	TOOL KITS	10
265 - 274	ACCESSORIES AND TAPPING MACHINES	11
275 - 340	TECHNICAL INFORMATION	12



MACHINE TAPS

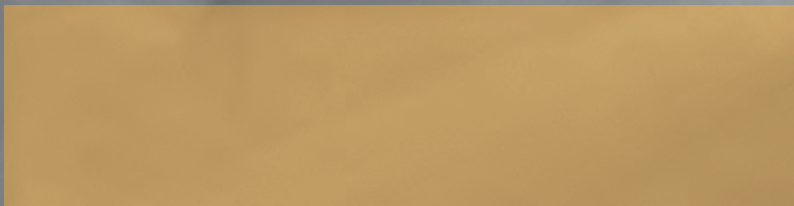

SELECTION TABLE

1 - 3

CATALOGUE PAGES

17 - 89

M	DIN-371 DIN-376	High performance machine taps	MASTER TAP 800X 800	17 - 27
	DIN-371 EL DIN-376 EL	High performance machine taps - extra long	800X 800	28
	DIN-371 DIN-376	High performance machine taps	FAN-1200 1400-HT INOX GG GAL HRC60 S-NC	29 - 34
	DIN-352	Short machine taps		35
	NUT-TAP NGMf KOMBI BIT	Machine NUT TAPS Combined taps Machine taps - BITS	NUT-TAP NGMf BIT KOMBI	36 - 39
MF	DIN-371 DIN-374	High performance machine taps	MASTER TAP 800X 800 FAN-1200 1400-HT INOX GG GAL S-NC	40 - 56
	DIN-2181	Short machine taps		57 - 59
	NUT-TAP NGMf	Machine NUT TAPS	NUT-TAP NGMf	60 - 62
UNC	DIN-371 DIN-376	High performance machine taps	MASTER TAP 800X 800	63 - 65
	DIN-352	Short machine taps		66
UNF	DIN-371 DIN-374	High performance machine taps	MASTER TAP 800X 800	67 - 69
	DIN-2181	Short machine taps		70
UNEF	~DIN-374	High performance machine taps	800X 800	71 - 72
UNJC	DIN-371 DIN-376	High performance machine taps	1400-HT	73
UNJF	DIN-371 DIN-374	High performance machine taps	1400-HT	74
G	DIN-5156	High performance machine taps	MASTER TAP 800X 800	75 - 77
	~DIN-5157	Short machine taps	Ms	78
	DIN-5157	Short machine taps		79
	NGRf	Machine NUT TAPS	NGRf	80
Rp/Rc	DIN-5156	High performance machine taps	800	81
	~DIN-5156	High performance machine taps	800	81
NPT	~DIN-371 ~DIN-374	High performance machine taps	800	82
NPTF	~DIN-374	High performance machine taps	800	83
NPSF	~DIN-374	High performance machine taps	800	84
BSW	DIN-371 DIN-376	High performance machine taps	800	85
EG ^M _{STI}	~DIN-371 ~DIN-376	High performance machine taps	MASTER TAP	86
EG ^{UNC} _{STI}	~DIN-371 ~DIN-376	High performance machine taps	MASTER TAP	87
EG ^{UNF} _{STI}	~DIN-371 ~DIN-376	High performance machine taps	MASTER TAP	88
TR	NGSt	Short machine taps	NGSt	89



MASTER TAP

ISO Metric coarse thread ISO DIN-13										MASTER TAP						
										B-HL	B-IKR-HL	C-R45-HL	C-R45-IK-HL	E-R45-HL	E-R45-IK-HL	
Material groups																
Hole type																
Quality of material										HSSE-PM						
Coating										HL						
Chamfer										B / 4-5P, C / 2-3P, E / 1,5-2P						
M Ød ₁	P	l ₁	l ₂	l ₂ R45	l ₃	Ød ₂	a		DIN-371							
									Norm	Tol.						INDEX
M1	0,25	40	6	6	13	2,5	2,1	0,75	0010	●		●				
M1,1	0,25	40	6	6	13	2,5	2,1	0,85	0011	●		●				
M1,2	0,25	40	6	6	13	2,5	2,1	0,95	0012	●		●				
M1,4	0,30	40	8	8	13	2,5	2,1	1,10	0014	●		●				
M Ød ₁	P	l ₁	l ₂	l ₂ R45	l ₃	Ød ₂	a		DIN-371							
									Norm	Tol.						INDEX
M1,6	0,35	40	8	8	13	2,5	2,1	1,25	0016	●		●				
M1,7	0,35	40	8	8	13	2,5	2,1	1,35	0017	●		●				
M1,8	0,35	40	8	8	13	2,5	2,1	1,45	0018	●		●				
M2	0,40	45	10	10	13	2,8	2,1	1,60	0020	●		●				
M2,2	0,45	45	10	10	13	2,8	2,1	1,75	0022	●		●				
M2,3	0,40	45	10	10	13	2,8	2,1	1,90	0023	●		●				
M2,5	0,45	50	9	5	14	2,8	2,1	2,05	0025	●		●				
M2,6	0,45	50	9	5	14	2,8	2,1	2,15	0026	●		●				
M Ød ₁	P	l ₁	l ₂	l ₂ R45	l ₃	Ød ₂	a		DIN-371							
									Norm	Tol.						INDEX
M3	0,50	56	5	5	18	3,5	2,7	2,50	0030	●	-	●	-	●	-	
M3,5	0,60	56	6	6	20	4,0	3,0	2,90	0035	●	-	●	-	●	-	
M4	0,70	63	7	7	21	4,5	3,4	3,30	0040	●	-	●	-	●	-	
M4,5	0,75	70	7,5	7,5	25	6,0	4,9	3,80	0045	●	-	●	-	●	-	
M5	0,80	70	8	8	25	6,0	4,9	4,20	0050	●	●	●	●	●	○	
M6	1,00	80	10	10	30	6,0	4,9	5,00	0060	●	●	●	●	●	○	
M7	1,00	80	10	10	30	7,0	5,5	6,00	0070	●	○	○	○	○	○	
M8	1,25	90	13	13	35	8,0	6,2	6,80	0080	●	●	●	●	●	○	
M9	1,25	90	13	13	35	9,0	7,0	7,80	0090	○	○	○	○	○	○	
M10	1,50	100	15	15	39	10,0	8,0	8,50	0100	●	●	●	●	●	○	

● Available from stock
○ On request

ISO	Vc (m/min)					
P	5-40	5-50	5-40	5-50	5-40	5-50
M	5-15	5-25	5-15	5-25	5-15	5-25
K	10-30	10-50	10-30	10-50	10-30	10-50
N	10-30	10-50	10-30	10-50	10-30	10-50
S	1-8	1-8	1-8	1-8	1-8	1-8

1

ISO Metric coarse thread ISO DIN-13

MASTERTAP



HSSE
PM

HL

DIN
376

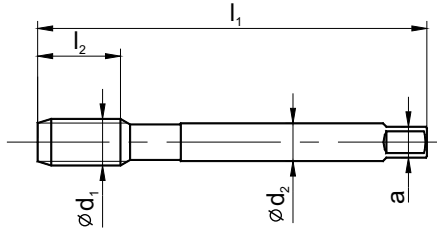

B-HL B-IKR-HL C-R45-HL C-R45-IK-HL E-R45-HL E-R45-IK-HL



Material groups



Hole type



Quality of material

HSSE-PM HSSE-PM HSSE-PM HSSE-PM HSSE-PM HSSE-PM

Coating

HL HL HL HL HL HL

Chamfer

B / 4-5P B / 4-5P C / 2-3P C / 2-3P E / 1,5-2P E / 1,5-2P

M Ød ₁	P	l ₁	l ₂	l ₃	Ød ₂	a		Norm	DIN-376						
									Tol.	6HX	6HX	6HX	6HX	6HX	6HX
									INDEX	D4-118M01	D4-118M61	D4-528M01	D4-528M51	D4-718M01	D4-718M51
M8	1,25	90	15	-	6,0	4,9	6,80	0080	●	○	●	○	○	○	
M10	1,50	100	17	-	7,0	5,5	8,50	0100	●	○	●	○	○	○	
M12	1,75	110	18	-	9,0	7,0	10,20	0120	●	●	●	●	●	○	
M14	2,00	110	20	-	11,0	9,0	12,00	0140	●	●	●	●	●	○	
M16	2,00	110	20	-	12,0	9,0	14,00	0160	●	●	●	●	●	○	
M18	2,50	125	25	-	14,0	11,0	15,50	0180	●	○	●	○	○	○	
M20	2,50	140	25	-	16,0	12,0	17,50	0200	●	○	●	○	○	○	
M22	2,50	140	25	-	18,0	14,5	19,50	0220	●	○	●	○	○	○	
M24	3,00	160	30	-	18,0	14,5	21,00	0240	●	○	●	○	○	○	
M27	3,00	160	30	-	20,0	16,0	24,00	0270	●	○	●	○	○	○	
M30	3,50	180	35	-	22,0	18,0	26,50	0300	●	○	●	○	○	○	
M33	3,50	180	35	-	25,0	20,0	29,50	0330	●	○	●	○	○	○	
M36	4,00	200	40	-	28,0	22,0	32,00	0360	●	○	●	○	○	○	

ISO	Vc (m/min)					
P	5-40	5-50	5-40	5-50	5-40	5-50
M	5-15	5-25	5-15	5-25	5-15	5-25
K	10-30	10-50	10-30	10-50	10-30	10-50
N	10-30	10-50	10-30	10-50	10-30	10-50
S	1-8	1-8	1-8	1-8	1-8	1-8

MASTERTAP



ISO Metric coarse thread ISO DIN-13										800X						
										C	C-LH	B	B-LH	B	B	
 											 LH		 LH	 6G	 7G	
Material groups										P M K N S H	P M K N S H	P M K N S H	P M K N S H	P M K N S H	P M K N S H	
Hole type																
Quality of material										HSSE	HSSE	HSSE	HSSE	HSSE	HSSE	
Coating										TN2	TN2	TN2	TN2	TN2	TN2	
Chamfer										C / 2-3P	C / 2-3P	B / 4-5P	B / 4-5P	B / 4-5P	B / 4-5P	
M Ød ₁	P	l ₁	l ₂	l ₂ R40	l ₃	Ød ₂	a		Norm DIN-371							
									Tol.	ISO1(4H)	ISO1(4H)					
									INDEX	C4-123X02		C4-113X02				
M1	0,25	40	6	-	13	2,5	2,1	0,75	0010	●		●				
M1,1	0,25	40	6	-	13	2,5	2,1	0,85	0011	●		●				
M1,2	0,25	40	6	-	13	2,5	2,1	0,95	0012	●		●				
M1,4	0,30	40	7	-	13	2,5	2,1	1,10	0014	●		●				
M Ød ₁	P	l ₁	l ₂	l ₂ R40	l ₃	Ød ₂	a		Norm DIN-371							
									Tol.	ISO2 (6H)	ISO2 (6H)	ISO2 (6H)	ISO2 (6H)	ISO3 (6G)	7G	
									INDEX	C4-123X01		C4-113X01				
M1,6	0,35	40	8	-	13	2,5	2,1	1,25	0016	●		●				
M1,7	0,35	40	8	-	13	2,5	2,1	1,35	0017	●		●				
M1,8	0,35	40	8	-	13	2,5	2,1	1,45	0018	●		●				
M2	0,40	45	10	-	13	2,8	2,1	1,60	0020	●		●				
M2,2	0,45	45	10	-	13	2,8	2,1	1,75	0022	●		●				
M2,3	0,40	45	10	-	13	2,8	2,1	1,90	0023	●		●				
M2,5	0,45	50	9	-	14	2,8	2,1	2,05	0025	●		●				
M2,6	0,45	50	9	-	14	2,8	2,1	2,15	0026	●		●				
M Ød ₁	P	l ₁	l ₂	l ₂ R40	l ₃	Ød ₂	a		Norm DIN-371							
									Tol.	ISO2 (6H)	ISO2 (6H)	ISO2 (6H)	ISO2 (6H)	ISO3 (6G)	7G	
									INDEX	C2-123X01	C2-223X01	C2-113X01	C2-213X01	C2-113X03	C2-113X04	
M3	0,50	56	10	-	18	3,5	2,7	2,50	0030	●	●	●	●	●	○	
M3,5	0,60	56	12	-	20	4,0	3,0	2,90	0035	●	○	●	○	○	○	
M4	0,70	63	12	-	21	4,5	3,4	3,30	0040	●	●	●	●	●	○	
M4,5	0,75	70	14	-	25	6,0	4,9	3,80	0045	●	○	●	○	○	○	
M5	0,80	70	14	-	25	6,0	4,9	4,20	0050	●	●	●	●	●	○	
M6	1,00	80	18	-	30	6,0	4,9	5,00	0060	●	●	●	●	●	○	
M7	1,00	80	18	-	30	7,0	5,5	6,00	0070	●	○	●	○	○	○	
M8	1,25	90	20	-	35	8,0	6,2	6,80	0080	●	●	●	●	●	○	
M9	1,25	90	20	-	35	9,0	7,0	7,80	0090	●	○	●	○	○	○	
M10	1,50	100	20	-	39	10,0	8,0	8,50	0100	●	●	●	●	●	○	
										Vc (m/min)						
										P	M	K	N	S		
										5-35	5-35	5-35	5-35	5-35	5-35	5-35
										5-15	5-15	5-15	5-15	5-15	5-15	5-15
										5-25	5-25	5-25	5-25	5-25	5-25	5-25
										10-30	10-30	10-30	10-30	10-30	10-30	10-30
										-	-	-	-	-	-	-

● Available from stock
○ On request

1

ISO Metric coarse thread ISO DIN-13

800X



HSSE

TN2

DIN 376

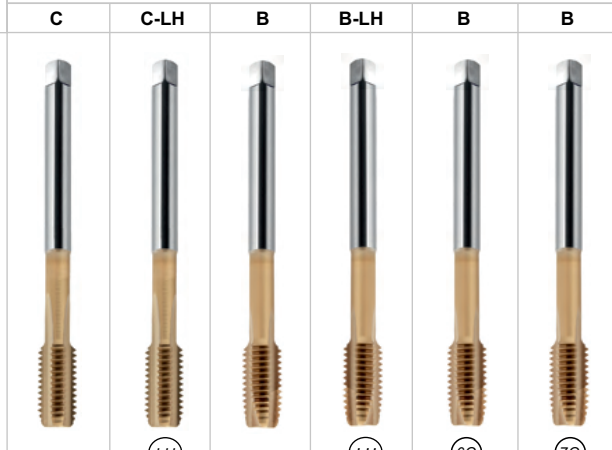
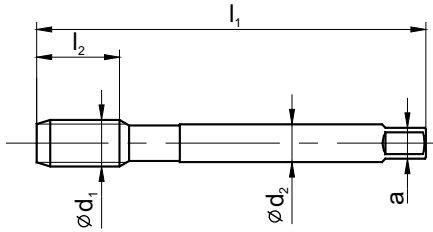

Material groups

P	M	K	P	M	K	P	M	K	P	M	K	P	M	K	P	M	K
N	S	H	N	S	H	N	S	H	N	S	H	N	S	H	N	S	H

Hole type



Quality of material

HSSE HSSE HSSE HSSE HSSE HSSE

Coating

TN2 TN2 TN2 TN2 TN2 TN2

Chamfer

C / 2-3P C / 2-3P B / 4-5P B / 4-5P B / 4-5P B / 4-5P

M Ød ₁	P	l ₁	l ₂	l ₂ R40	l ₃	Ød ₂	a		DIN-376							
									Norm							
									Tol.	ISO2 (6H)	ISO2 (6H)	ISO2 (6H)	ISO2 (6H)	ISO3 (6G)	7G	
INDEX	D2-123X01	D2-223X01	D2-113X01	D2-213X01	D2-113X03	D2-113X04										
M3	0,50	56	11	-	-	2,2	1,8	2,50	0030	●	○	●	○	○	○	○
M4	0,70	63	12	-	-	2,8	2,1	3,30	0040	●	○	●	○	○	○	○
M5	0,80	70	14	-	-	3,5	2,7	4,20	0050	●	○	●	○	○	○	○
M6	1,00	80	18	-	-	4,5	3,4	5,00	0060	●	○	●	○	○	○	○
M8	1,25	90	20	-	-	6,0	4,9	6,80	0080	●	○	●	○	○	○	○
M10	1,50	100	20	-	-	7,0	5,5	8,50	0100	●	○	●	○	○	○	○
M12	1,75	110	24	-	-	9,0	7,0	10,20	0120	●	●	●	●	●	○	○
M14	2,00	110	25	-	-	11,0	9,0	12,00	0140	●	○	●	○	○	○	○
M16	2,00	110	32	-	-	12,0	9,0	14,00	0160	●	●	●	●	●	○	○
M18	2,50	125	32	-	-	14,0	11,0	15,50	0180	●	○	●	○	○	○	○
M20	2,50	140	32	-	-	16,0	12,0	17,50	0200	●	●	●	●	●	○	○
M22	2,50	140	32	-	-	18,0	14,5	19,50	0220	●	○	●	○	○	○	○
M24	3,00	160	38	-	-	18,0	14,5	21,00	0240	●	●	●	●	○	○	○
M27	3,00	160	38	-	-	20,0	16,0	24,00	0270	●	○	●	○	○	○	○
M30	3,50	180	45	-	-	22,0	18,0	26,50	0300	●	○	●	○	○	○	○
M33	3,50	180	45	-	-	25,0	20,0	29,50	0330	●	○	●	○	○	○	○
M36	4,00	200	50	-	-	28,0	22,0	32,00	0360	●	○	●	○	○	○	○
M39	4,00	200	50	-	-	32,0	24,0	35,00	0390	●	○	●	○	○	○	○
M42	4,50	200	60	-	-	32,0	24,0	37,50	0420	●	○	●	○	○	○	○
M45	4,50	220	60	-	-	36,0	29,0	40,50	0450	●	○	●	○	○	○	○
M48	5,00	250	65	-	-	36,0	29,0	43,00	0480	●	○	●	○	○	○	○
M52	5,00	250	65	-	-	40,0	32,0	47,00	0520	●	○	●	○	○	○	○

ISO	Vc (m/min)					
P	5-35	5-35	5-35	5-35	5-35	5-35
M	5-15	5-15	5-15	5-15	5-15	5-15
K	5-25	5-25	5-25	5-25	5-25	5-25
N	10-30	10-30	10-30	10-30	10-30	10-30
S	-	-	-	-	-	-

800X



ISO Metric coarse thread ISO DIN-13										800X																																																						
 										C-R40	C-LH-L40	C-R40	C-R40																																																			
Material groups										P M K N S H	P M K N S H	P M K N S H	P M K N S H																																																			
Hole type																																																																
Quality of material										HSSE	HSSE	HSSE	HSSE																																																			
Coating										TN2	TN2	TN2	TN2																																																			
Chamfer										C / 2-3P	C / 2-3P	C / 2-3P	C / 2-3P																																																			
<table border="1"> <thead> <tr> <th>M</th> <th>P</th> <th>l₁</th> <th>l₂</th> <th>l₂ R40</th> <th>l₃</th> <th>Ød₂</th> <th>a</th> <th></th> <th>Norm</th> <th>DIN-371</th> <th></th> <th></th> <th></th> <th></th> <th></th> </tr> </thead> <tbody> <tr> <td>Ød₁</td> <td></td> <td></td> <td></td> <td></td> <td></td> <td></td> <td></td> <td></td> <td>Tol.</td> <td>ISO1(4H)</td> <td></td> <td></td> <td></td> <td></td> <td></td> </tr> <tr> <td></td> <td></td> <td></td> <td></td> <td></td> <td></td> <td></td> <td></td> <td></td> <td>INDEX</td> <td>C4-513X02</td> <td></td> <td></td> <td></td> <td></td> <td></td> </tr> </tbody> </table>										M	P	l ₁	l ₂	l ₂ R40	l ₃	Ød ₂	a		Norm	DIN-371						Ød ₁									Tol.	ISO1(4H)															INDEX	C4-513X02						DIN-371						
										M	P	l ₁	l ₂	l ₂ R40	l ₃	Ød ₂	a		Norm	DIN-371																																												
Ød ₁									Tol.	ISO1(4H)																																																						
									INDEX	C4-513X02																																																						
										ISO2 (6H)																																																						
										INDEX	C4-513X01																																																					
M1										0,25	40	-	6	13	2,5	2,1	0,75	0010	●																																													
M1,1										0,25	40	-	6	13	2,5	2,1	0,85	0011	●																																													
M1,2										0,25	40	-	6	13	2,5	2,1	0,95	0012	●																																													
M1,4										0,30	40	-	8	13	2,5	2,1	1,10	0014	●																																													
										DIN-371																																																						
										ISO2 (6H)																																																						
										INDEX	C4-513X01																																																					
M1,6										0,35	40	-	8	13	2,5	2,1	1,25	0016	●																																													
M1,7										0,35	40	-	8	13	2,5	2,1	1,35	0017	●																																													
M1,8										0,35	40	-	8	13	2,5	2,1	1,45	0018	●																																													
M2										0,40	45	-	10	13	2,8	2,1	1,60	0020	●																																													
M2,2										0,45	45	-	10	13	2,8	2,1	1,75	0022	●																																													
M2,3										0,40	45	-	10	13	2,8	2,1	1,90	0023	●																																													
M2,5										0,45	50	-	5	14	2,8	2,1	2,05	0025	●																																													
M2,6										0,45	50	-	5	14	2,8	2,1	2,15	0026	●																																													
										DIN-371																																																						
										ISO2 (6H)	ISO2 (6H)	ISO3 (6G)	7G																																																			
										INDEX	C2-513X01	C2-593X01	C2-513X03	C2-513X04																																																		
M3										0,50	56	-	5	18	3,5	2,7	2,50	0030	●	●	●	○																																										
M3,5										0,60	56	-	6	20	4,0	3,0	2,90	0035	●	○	○	○																																										
M4										0,70	63	-	7	21	4,5	3,4	3,30	0040	●	●	●	○																																										
M4,5										0,75	70	-	7,5	25	6,0	4,9	3,80	0045	●	○	○	○																																										
M5										0,80	70	-	8	25	6,0	4,9	4,20	0050	●	●	●	○																																										
M6										1,00	80	-	10	30	6,0	4,9	5,00	0060	●	●	●	○																																										
M7										1,00	80	-	10	30	7,0	5,5	6,00	0070	●	○	○	○																																										
M8										1,25	90	-	13	35	8,0	6,2	6,80	0080	●	●	●	○																																										
M9										1,25	90	-	13	35	9,0	7,0	7,80	0090	●	○	○	○																																										
M10										1,50	100	-	15	39	10,0	8,0	8,50	0100	●	●	●	○																																										
										ISO	Vc (m/min)																																																					
										P	5-35	5-35	5-35	5-35																																																		
										M	5-15	5-15	5-15	5-15																																																		
										K	5-25	5-25	5-25	5-25																																																		
										N	10-30	10-30	10-30	10-30																																																		
										S	-	-	-	-																																																		

1

ISO Metric coarse thread ISO DIN-13

800X



HSSE

TN2

DIN 376

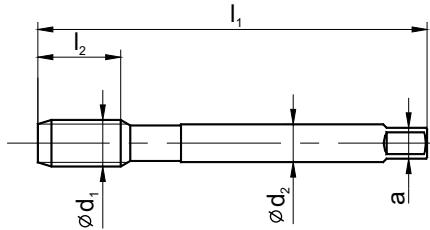

Material groups



Hole type

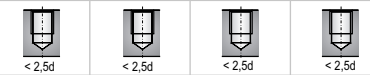

Quality of material

HSSE HSSE HSSE HSSE

Coating

TN2 TN2 TN2 TN2

Chamfer

C / 2-3P C / 2-3P C / 2-3P C / 2-3P

M Ød ₁	P	l ₁	l ₂	l ₂ R40	l ₃	Ød ₂	a		Norm								
									DIN-376				INDEX				
									Tol.	ISO2 (6H)	ISO2 (6H)	ISO3 (6G)					
M3	0,50	56	-	5	-	2,2	1,8	2,50	0030	●	○	○	○				
M4	0,70	63	-	8	-	2,8	2,1	3,30	0040	●	○	○	○				
M5	0,80	70	-	10	-	3,5	2,7	4,20	0050	●	○	○	○				
M6	1,00	80	-	12	-	4,5	3,4	5,00	0060	●	○	○	○				
M8	1,25	90	-	15	-	6,0	4,9	6,80	0080	●	○	○	○				
M10	1,50	100	-	17	-	7,0	5,5	8,50	0100	●	○	○	○				
M12	1,75	110	-	18	-	9,0	7,0	10,20	0120	●	●	●	○				
M14	2,00	110	-	20	-	11,0	9,0	12,00	0140	●	○	○	○				
M16	2,00	110	-	20	-	12,0	9,0	14,00	0160	●	●	●	○				
M18	2,50	125	-	25	-	14,0	11,0	15,50	0180	●	○	○	○				
M20	2,50	140	-	25	-	16,0	12,0	17,50	0200	●	●	●	○				
M22	2,50	140	-	25	-	18,0	14,5	19,50	0220	●	○	○	○				
M24	3,00	160	-	30	-	18,0	14,5	21,00	0240	●	●	○	○				
M27	3,00	160	-	30	-	20,0	16,0	24,00	0270	●	○	○	○				
M30	3,50	180	-	35	-	22,0	18,0	26,50	0300	●	○	○	○				
M33	3,50	180	-	35	-	25,0	20,0	29,50	0330	●	○	○	○				
M36	4,00	200	-	40	-	28,0	22,0	32,00	0360	●	○	○	○				
M39	4,00	200	-	40	-	32,0	24,0	35,00	0390	●	○	○	○				
M42	4,50	200	-	45	-	32,0	24,0	37,50	0420	●	○	○	○				
M45	4,50	220	-	45	-	36,0	29,0	40,50	0450	●	○	○	○				
M48	5,00	250	-	50	-	36,0	29,0	43,00	0480	●	○	○	○				
M52	5,00	250	-	50	-	40,0	32,0	47,00	0520	●	○	○	○				

ISO	V _c (m/min)			
P	5-35	5-35	5-35	5-35
M	5-15	5-15	5-15	5-15
K	5-25	5-25	5-25	5-25
N	10-30	10-30	10-30	10-30
S	-	-	-	-

● Available from stock
○ On request

800X



ISO Metric coarse thread ISO DIN-13										800X																			
										B		C-R40																	
Material groups										<table border="1"> <tr><td>P</td><td>M</td><td>K</td></tr> <tr><td>N</td><td>S</td><td>H</td></tr> </table>		P	M	K	N	S	H	<table border="1"> <tr><td>P</td><td>M</td><td>K</td></tr> <tr><td>N</td><td>S</td><td>H</td></tr> </table>		P	M	K	N	S	H				
P	M	K																											
N	S	H																											
P	M	K																											
N	S	H																											
Hole type																													
Quality of material										HSSE		HSSE																	
Coating										TN2		TN2																	
Chamfer										B / 4-5P		C / 2-3P																	
										Norm		DIN-371-EL																	
										Tol.		ISO2 (6H)																	
										INDEX		C2-113X21		C2-513X21															
M	P	l_1	l_2	l_2 R40	l_3	$\varnothing d_2$	a																						
M3	0,50	100	10	5	18	3,5	2,7	2,50	0030	●	●																		
M3,5	0,60	100	12	6	20	4,0	3,0	2,90	0035	○	○																		
M4	0,70	125	12	7	21	4,5	3,4	3,30	0040	●	●																		
M5	0,80	140	14	8	25	6,0	4,9	4,20	0050	●	●																		
M6	1,00	160	18	10	30	6,0	4,9	5,00	0060	●	●																		

										Norm		DIN-376-EL							
										Tol.		ISO2 (6H)							
										INDEX		D2-113X21		D2-513X21					
M8	1,25	180	20	15	-	6,0	4,9	6,80	0080	●	●								
M10	1,50	200	20	17	-	7,0	5,5	8,50	0100	●	●								
M12	1,75	220	24	18	-	9,0	7,0	10,20	0120	●	●								
M14	2,00	220	25	20	-	11,0	9,0	12,00	0140	○	○								
M16	2,00	220	32	20	-	12,0	9,0	14,00	0160	●	●								
M20	2,50	250	32	25	-	16,0	12,0	17,50	0200	○	○								

ISO	Vc (m/min)			
P	5-35	5-35		
M	5-15	5-15		
K	5-25	5-25		
N	10-30	10-30		
S	-	-		

ISO Metric coarse thread ISO DIN-13										800													
										C	C-LH	B	B-LH	B	B								
 											 LH		 LH	 6G	 7G								
Material groups										P M K N S H	P M K N S H	P M K N S H	P M K N S H	P M K N S H	P M K N S H								
Hole type										< 1,5d	< 1,5d	< 3d	< 3d	< 3d	< 3d								
Quality of material										HSSE	HSSE	HSSE	HSSE	HSSE	HSSE								
Coating																							
Chamfer										C / 2-3P	C / 2-3P	B / 4-5P	B / 4-5P	B / 4-5P	B / 4-5P								
M Ød ₁	P	l ₁	l ₂	l ₂ R40	l ₃	Ød ₂	a		Norm														
									DIN-371														
										Tol.	ISO1(4H)		ISO1(4H)										
										INDEX	C4-121102		C4-111102										
M1	0,25	40	6	-	13	2,5	2,1	0,75	0010	●		●											
M1,1	0,25	40	6	-	13	2,5	2,1	0,85	0011	●		●											
M1,2	0,25	40	6	-	13	2,5	2,1	0,95	0012	●		●											
M1,4	0,30	40	7	-	13	2,5	2,1	1,10	0014	●		●											
M Ød ₁	P	l ₁	l ₂	l ₂ R40	l ₃	Ød ₂	a		Norm														
									DIN-371														
										Tol.	ISO2 (6H)		ISO2 (6H)										
										INDEX	C4-121101		C4-111101										
M1,6	0,35	40	8	-	13	2,5	2,1	1,25	0016	●		●											
M1,7	0,35	40	8	-	13	2,5	2,1	1,35	0017	●		●											
M1,8	0,35	40	8	-	13	2,5	2,1	1,45	0018	●		●											
M2	0,40	45	10	-	13	2,8	2,1	1,60	0020	●		●											
M2,2	0,45	45	10	-	13	2,8	2,1	1,75	0022	●		●											
M2,3	0,40	45	10	-	13	2,8	2,1	1,90	0023	●		●											
M2,5	0,45	50	9	-	14	2,8	2,1	2,05	0025	●		●											
M2,6	0,45	50	9	-	14	2,8	2,1	2,15	0026	●		●											
M Ød ₁	P	l ₁	l ₂	l ₂ R40	l ₃	Ød ₂	a		Norm														
									DIN-371														
										Tol.	ISO2 (6H)	ISO2 (6H)	ISO2 (6H)	ISO2 (6H)	ISO3 (6G)	7G							
										INDEX	C2-121101	C2-221101	C2-111101	C2-211101	C2-111103	C2-111104							
M3	0,50	56	10	-	18	3,5	2,7	2,50	0030	●	●	●	●	●	○								
M3,5	0,60	56	12	-	20	4,0	3,0	2,90	0035	●	○	●	○	○	○								
M4	0,70	63	12	-	21	4,5	3,4	3,30	0040	●	●	●	●	●	○								
M4,5	0,75	70	14	-	25	6,0	4,9	3,80	0045	●	○	●	○	○	○								
M5	0,80	70	14	-	25	6,0	4,9	4,20	0050	●	●	●	●	●	○								
M6	1,00	80	18	-	30	6,0	4,9	5,00	0060	●	●	●	●	●	○								
M7	1,00	80	18	-	30	7,0	5,5	6,00	0070	●	○	●	○	○	○								
M8	1,25	90	20	-	35	8,0	6,2	6,80	0080	●	●	●	●	●	○								
M9	1,25	90	20	-	35	9,0	7,0	7,80	0090	●	○	●	○	○	○								
M10	1,50	100	20	-	39	10,0	8,0	8,50	0100	●	●	●	●	●	○								
										ISO							Vc (m/min)						
										P	5-20	5-20	5-20	5-20	5-20	5-20							
										M	5-10	5-10	5-10	5-10	5-10	5-10							
										K	5-15	5-15	5-15	5-15	5-15	5-15							
										N	5-25	5-25	5-25	5-25	5-25	5-25							
										S	-	-	-	-	-	-							

● Available from stock
○ On request



ISO Metric coarse thread ISO DIN-13										800						
										C	C-LH	B	B-LH	B	B	
Material groups										P M K N S H	P M K N S H	P M K N S H	P M K N S H	P M K N S H	P M K N S H	
Hole type																
Quality of material										HSSE	HSSE	HSSE	HSSE	HSSE	HSSE	
Coating																
Chamfer										C / 2-3P	C / 2-3P	B / 4-5P	B / 4-5P	B / 4-5P	B / 4-5P	
M Ød ₁	P	l ₁	l ₂	l ₂ R40	l ₃	Ød ₂	a		Norm		DIN-376					
									Tol.	ISO2 (6H)	ISO2 (6H)	ISO2 (6H)	ISO2 (6H)	ISO3 (6G)	7G	
									INDEX	D2-121101	D2-221101	D2-111101	D2-211101	D2-111103	D2-111104	
M3	0,50	56	11	-	-	2,2	1,8	2,50	0030	●	○	●	○	○	○	○
M4	0,70	63	12	-	-	2,8	2,1	3,30	0040	●	○	●	○	○	○	○
M5	0,80	70	14	-	-	3,5	2,7	4,20	0050	●	○	●	○	○	○	○
M6	1,00	80	18	-	-	4,5	3,4	5,00	0060	●	○	●	○	○	○	○
M8	1,25	90	20	-	-	6,0	4,9	6,80	0080	●	○	●	○	○	○	○
M10	1,50	100	20	-	-	7,0	5,5	8,50	0100	●	○	●	○	○	○	○
M12	1,75	110	24	-	-	9,0	7,0	10,20	0120	●	●	●	●	●	○	○
M14	2,00	110	25	-	-	11,0	9,0	12,00	0140	●	○	●	○	○	○	○
M16	2,00	110	32	-	-	12,0	9,0	14,00	0160	●	●	●	●	●	○	○
M18	2,50	125	32	-	-	14,0	11,0	15,50	0180	●	○	●	○	○	○	○
M20	2,50	140	32	-	-	16,0	12,0	17,50	0200	●	●	●	●	●	○	○
M22	2,50	140	32	-	-	18,0	14,5	19,50	0220	●	○	●	○	○	○	○
M24	3,00	160	38	-	-	18,0	14,5	21,00	0240	●	●	●	●	○	○	○
M27	3,00	160	38	-	-	20,0	16,0	24,00	0270	●	○	●	○	○	○	○
M30	3,50	180	45	-	-	22,0	18,0	26,50	0300	●	○	●	○	○	○	○
M33	3,50	180	45	-	-	25,0	20,0	29,50	0330	●	○	●	○	○	○	○
M36	4,00	200	50	-	-	28,0	22,0	32,00	0360	●	○	●	○	○	○	○
M39	4,00	200	50	-	-	32,0	24,0	35,00	0390	●	○	●	○	○	○	○
M42	4,50	200	60	-	-	32,0	24,0	37,50	0420	●	○	●	○	○	○	○
M45	4,50	220	60	-	-	36,0	29,0	40,50	0450	●	○	●	○	○	○	○
M48	5,00	250	65	-	-	36,0	29,0	43,00	0480	●	○	●	○	○	○	○
M52	5,00	250	65	-	-	40,0	32,0	47,00	0520	●	○	●	○	○	○	○
										V _c (m/min)						
										ISO						
										P	5-35	5-20	5-20	5-20	5-20	5-20
										M	5-10	5-10	5-10	5-10	5-10	5-10
										K	10-25	5-15	5-15	5-15	5-15	5-15
										N	10-35	5-25	5-25	5-25	5-25	5-25
										S	-	-	-	-	-	-

1

ISO Metric coarse thread ISO DIN-13										800								
										C-R40	C-LH-L40	C-R40	C-R40					
Material groups										P M K	P M K	P M K	P M K					
Hole type																		
Quality of material										HSSE	HSSE	HSSE	HSSE					
Coating																		
Chamfer										C / 2-3P	C / 2-3P	C / 2-3P	C / 2-3P					
M Ød ₁	P	l ₁	l ₂	l ₂ R40	l ₃	Ød ₂	a		Norm	DIN-371								
									Tol.	ISO1(4H)								
									INDEX	C4-511102								
M1	0,25	40	-	6	13	2,5	2,1	0,75	0010	●								
M1,1	0,25	40	-	6	13	2,5	2,1	0,85	0011	●								
M1,2	0,25	40	-	6	13	2,5	2,1	0,95	0012	●								
M1,4	0,30	40	-	8	13	2,5	2,1	1,10	0014	●								
M Ød ₁	P	l ₁	l ₂	l ₂ R40	l ₃	Ød ₂	a		Norm	DIN-371								
									Tol.	ISO2 (6H)								
									INDEX	C4-511101								
M1,6	0,35	40	-	8	13	2,5	2,1	1,25	0016	●								
M1,7	0,35	40	-	8	13	2,5	2,1	1,35	0017	●								
M1,8	0,35	40	-	8	13	2,5	2,1	1,45	0018	●								
M2	0,40	45	-	10	13	2,8	2,1	1,60	0020	●								
M2,2	0,45	45	-	10	13	2,8	2,1	1,75	0022	●								
M2,3	0,40	45	-	10	13	2,8	2,1	1,90	0023	●								
M2,5	0,45	50	-	5	14	2,8	2,1	2,05	0025	●								
M2,6	0,45	50	-	5	14	2,8	2,1	2,15	0026	●								
M Ød ₁	P	l ₁	l ₂	l ₂ R40	l ₃	Ød ₂	a		Norm	DIN-371								
									Tol.	ISO2 (6H)	ISO2 (6H)	ISO3 (6G)	7G					
									INDEX	C2-511101	C2-591101	C2-511103	C2-511104					
M3	0,50	56	-	5	18	3,5	2,7	2,50	0030	●	●	●	○					
M3,5	0,60	56	-	6	20	4,0	3,0	2,90	0035	●	○	○	○					
M4	0,70	63	-	7	21	4,5	3,4	3,30	0040	●	●	●	○					
M4,5	0,75	70	-	7,5	25	6,0	4,9	3,80	0045	●	○	○	○					
M5	0,80	70	-	8	25	6,0	4,9	4,20	0050	●	●	●	○					
M6	1,00	80	-	10	30	6,0	4,9	5,00	0060	●	●	●	○					
M7	1,00	80	-	10	30	7,0	5,5	6,00	0070	●	○	○	○					
M8	1,25	90	-	13	35	8,0	6,2	6,80	0080	●	●	●	○					
M9	1,25	90	-	13	35	9,0	7,0	7,80	0090	●	○	○	○					
M10	1,50	100	-	15	39	10,0	8,0	8,50	0100	●	●	●	○					
										ISO				Vc (m/min)				
										P	5-20	5-20	5-20	5-20				
										M	5-10	5-10	5-10	5-10				
										K	5-15	5-15	5-15	5-15				
										N	5-25	5-25	5-25	5-25				
										S	-	-	-	-				

● Available from stock
○ On request



ISO Metric coarse thread ISO DIN-13									800																														
									C-R40	C-LH-L40	C-R40	C-R40																											
Material groups									<table border="1"> <tr> <td>P</td><td>M</td><td>K</td> <td>P</td><td>M</td><td>K</td> <td>P</td><td>M</td><td>K</td> <td>P</td><td>M</td><td>K</td> </tr> <tr> <td>N</td><td>S</td><td>H</td> <td>N</td><td>S</td><td>H</td> <td>N</td><td>S</td><td>H</td> <td>N</td><td>S</td><td>H</td> </tr> </table>				P	M	K	P	M	K	P	M	K	P	M	K	N	S	H	N	S	H	N	S	H	N	S	H			
P	M	K	P	M	K	P	M	K	P	M	K																												
N	S	H	N	S	H	N	S	H	N	S	H																												
Hole type																																							
Quality of material									HSSE																														
Coating																																							
Chamfer									C / 2-3P																														
M Ød ₁	P	l ₁	l ₂	l ₂ R40	l ₃	Ød ₂	a		Norm																														
									DIN-376				INDEX																										
									Tol.	ISO2 (6H)	ISO2 (6H)	ISO3 (6G)					7G																						
									D2-511101	D2-591101	D2-511103	D2-511104																											
M3	0,50	56	-	5	-	2,2	1,8	2,50	0030	●	○	○	○																										
M4	0,70	63	-	8	-	2,8	2,1	3,30	0040	●	○	○	○																										
M5	0,80	70	-	10	-	3,5	2,7	4,20	0050	●	○	○	○																										
M6	1,00	80	-	12	-	4,5	3,4	5,00	0060	●	○	○	○																										
M8	1,25	90	-	15	-	6,0	4,9	6,80	0080	●	○	○	○																										
M10	1,50	100	-	17	-	7,0	5,5	8,50	0100	●	○	○	○																										
M12	1,75	110	-	18	-	9,0	7,0	10,20	0120	●	●	●	○																										
M14	2,00	110	-	20	-	11,0	9,0	12,00	0140	●	○	○	○																										
M16	2,00	110	-	20	-	12,0	9,0	14,00	0160	●	●	●	○																										
M18	2,50	125	-	25	-	14,0	11,0	15,50	0180	●	○	○	○																										
M20	2,50	140	-	25	-	16,0	12,0	17,50	0200	●	●	●	○																										
M22	2,50	140	-	25	-	18,0	14,5	19,50	0220	●	○	○	○																										
M24	3,00	160	-	30	-	18,0	14,5	21,00	0240	●	●	○	○																										
M27	3,00	160	-	30	-	20,0	16,0	24,00	0270	●	○	○	○																										
M30	3,50	180	-	35	-	22,0	18,0	26,50	0300	●	○	○	○																										
M33	3,50	180	-	35	-	25,0	20,0	29,50	0330	●	○	○	○																										
M36	4,00	200	-	40	-	28,0	22,0	32,00	0360	●	○	○	○																										
M39	4,00	200	-	40	-	32,0	24,0	35,00	0390	●	○	○	○																										
M42	4,50	200	-	45	-	32,0	24,0	37,50	0420	●	○	○	○																										
M45	4,50	220	-	45	-	36,0	29,0	40,50	0450	●	○	○	○																										
M48	5,00	250	-	50	-	36,0	29,0	43,00	0480	●	○	○	○																										
M52	5,00	250	-	50	-	40,0	32,0	47,00	0520	●	○	○	○																										
ISO									Vc (m/min)																														
P									5-20	5-20	5-20	5-20																											
M									5-10	5-10	5-10	5-10																											
K									5-15	5-15	5-15	5-15																											
N									5-25	5-25	5-25	5-25																											
S									-	-	-	-																											

1

ISO Metric coarse thread ISO DIN-13										800											
										B	C-R40										
<p>HSSE</p> <p>DIN 371-EL</p> <p>DIN 376-EL</p>																					
Material groups										<table border="1"> <tr><td>P</td><td>M</td><td>K</td></tr> <tr><td>N</td><td>S</td><td>H</td></tr> </table>		P	M	K	N	S	H				
P	M	K																			
N	S	H																			
Hole type										<table border="1"> <tr><td></td><td></td></tr> </table>											
Quality of material										HSSE											
Coating																					
Chamfer										B / 4-5P C / 2-3P											
M $\varnothing d_1$	P	l_1	l_2	l_{R40}	l_3	$\varnothing d_2$	a		Norm		DIN-371-EL										
									Tol.		ISO2 (6H)										
									INDEX		C2-111121	C2-511121									
M3	0,50	100	10	5	18	3,5	2,7	2,50	0030	●	●										
M3,5	0,60	100	12	6	20	4,0	3,0	2,90	0035	○	○										
M4	0,70	125	12	7	21	4,5	3,4	3,30	0040	●	●										
M5	0,80	140	14	8	25	6,0	4,9	4,20	0050	●	●										
M6	1,00	160	18	10	30	6,0	4,9	5,00	0060	●	●										

M $\varnothing d_1$	P	l_1	l_2	l_{R40}	l_3	$\varnothing d_2$	a		Norm		DIN-376-EL					
									Tol.		ISO2 (6H)					
									INDEX		D2-111121	D2-511121				
M8	1,25	180	20	15	-	6,0	4,9	6,80	0080	●	●					
M10	1,50	200	20	17	-	7,0	5,5	8,50	0100	●	●					
M12	1,75	220	24	18	-	9,0	7,0	10,20	0120	●	●					
M14	2,00	220	25	20	-	11,0	9,0	12,00	0140	○	○					
M16	2,00	220	32	20	-	12,0	9,0	14,00	0160	●	●					
M20	2,50	250	-	25	-	16,0	12,0	17,50	0200	○	○					

ISO	Vc (m/min)			
P	5-20	5-20		
M	5-10	5-10		
K	5-15	5-15		
N	5-25	5-25		
S	-	-		



ISO Metric coarse thread ISO DIN-13										<i>FAN-I200</i>		<i>1400-HT</i>							
										B-TS	C-R40-TS	C-TS	B-TS	C-R15-TS					
Material groups																			
Hole type																			
Quality of material										HSSE-PM		HSSE-PM		HSSE-PM		HSSE-PM		HSSE-PM	
Coating										TS		TS		TS		TS		TS	
Chamfer										B / 4-5P		C / 2-3P		C / 2-3P		B / 4-5P		C / 2-3P	
M Ød ₁	P	l ₁	l ₂	l ₂ R40	l ₃	Ød ₂	a		Norm										
									DIN-371										
										Tol.	ISO2 (6H)	ISO2 (6H)	6HX	6HX	6HX				
										INDEX	C4-115001	C4-565001	C4-12G901	C4-11G901	C4-50G901				
M 3	0,50	56	10	5	18	3,5	2,7	2,50	0030	●	●	●	●	●					
M 4	0,70	63	12	7	21	4,5	3,4	3,30	0040	●	●	●	●	●					
M 5	0,80	70	14	8	25	6,0	4,9	4,20	0050	●	●	●	●	●					
M 6	1,00	80	18	10	30	6,0	4,9	5,00	0060	●	●	●	●	●					
M 8	1,25	90	20	13	35	8,0	6,2	6,80	0080	●	●	●	●	●					
M10	1,50	100	20	15	39	10,0	8,0	8,50	0100	●	●	●	●	●					

M Ød ₁	P	l ₁	l ₂	l ₂ R40	l ₃	Ød ₂	a		Norm								
									DIN-376								
										Tol.	ISO2 (6H)	ISO2 (6H)	6HX	6HX	6HX		
										INDEX	D4-115001	D4-565001	D4-12G901	D4-11G901	D4-50G901		
M8	1,25	90	20	15	-	6,0	4,9	6,80	0080	●	●	●	●	●			
M10	1,50	100	20	17	-	7,0	5,5	8,50	0100	●	●	●	●	●			
M12	1,75	110	24	18	-	9,0	7,0	10,20	0120	●	●	●	●	●			
M14	2,00	110	25	20	-	11,0	9,0	12,00	0140	●	●	●	●	●			
M16	2,00	110	32	20	-	12,0	9,0	14,00	0160	●	●	●	●	●			
M18	2,50	125	32	25	-	14,0	11,0	15,50	0180	●	●	○	○	○			
M20	2,50	140	32	25	-	16,0	12,0	17,50	0200	●	●	●	●	●			
M22	2,50	140	32	25	-	18,0	14,5	19,50	0220	●	●	○	○	○			
M24	3,00	160	38	30	-	18,0	14,5	21,00	0240	●	●	●	●	●			
M27	3,00	160	38	30	-	20,0	16,0	24,00	0270	●	●	○	○	○			
M30	3,50	180	45	35	-	22,0	18,0	26,50	0300	●	●	○	○	○			
M33	3,50	180	45	35	-	25,0	20,0	29,50	0330	●	●	○	○	○			
M36	4,00	200	50	40	-	28,0	22,0	32,00	0360	●	●	○	○	○			

ISO	Vc (m/min)				
P	5-35	5-35	1-20	1-20	1-20
M	5-15	5-10	1-10	1-10	1-10
K	5-25	5-25	1-20	1-20	1-20
N	10-30	10-30	10-20	10-20	10-20
S	-	-	-	-	-

1

ISO Metric coarse thread ISO DIN-13										INOX									
										B	B-HL	C-R40	C-R40-HL						
 <div style="display: flex; flex-direction: column; gap: 5px;"> <div style="border: 1px solid black; padding: 2px; width: fit-content;">HSSE</div> <div style="border: 1px solid black; padding: 2px; width: fit-content;">HL</div> <div style="border: 1px solid black; padding: 2px; width: fit-content;">DIN 371</div> </div>																			
Material groups										P M K N S H	P M K N S H	P M K N S H	P M K N S H						
Hole type																			
Quality of material										HSSE	HSSE	HSSE	HSSE						
Coating											HL		HL						
Chamfer										B / 4-5P	B / 4-5P	C / 2-3P	C / 2-3P						
M Ød ₁	P	l ₁	l ₂	l ₂ R40	l ₃	Ød ₂	a		Norm										
									DIN-371										
									Tol.	ISO2 (6H)	ISO2 (6H)	ISO2 (6H)	ISO2 (6H)						
INDEX										C2-111801	C2-118801	C2-511801	C2-518801						
M3	0,50	56	10	5	18	3,5	2,7	2,50	0030	●	●	●	●						
M4	0,70	63	12	7	21	4,5	3,4	3,30	0040	●	●	●	●						
M5	0,80	70	14	8	25	6,0	4,9	4,20	0050	●	●	●	●						
M6	1,00	80	18	10	30	6,0	4,9	5,00	0060	●	●	●	●						
M8	1,25	90	20	13	35	8,0	6,2	6,80	0080	●	●	●	●						
M10	1,50	100	20	15	39	10,0	8,0	8,50	0100	●	●	●	●						
ISO										Vc (m/min)									
P										-	-	-	-						
M										5-15	5-15	5-15	5-15						
K										-	-	-	-						
N										-	-	-	-						
S										-	-	-	-						



ISO Metric coarse thread ISO DIN-13									INOX							
									B	B-HL	C-R40	C-R40-HL				
<div style="display: flex; flex-direction: column; align-items: center;"> <div style="border: 1px solid black; padding: 2px; margin-bottom: 5px;">HSSE</div> <div style="border: 1px solid black; padding: 2px; margin-bottom: 5px;">HL</div> <div style="border: 1px solid black; padding: 2px;">DIN 376</div> </div>									<div style="display: flex; justify-content: space-around;"> <div style="border: 1px solid black; padding: 2px;">P M K</div> <div style="border: 1px solid black; padding: 2px;">P M K</div> <div style="border: 1px solid black; padding: 2px;">P M K</div> <div style="border: 1px solid black; padding: 2px;">P M K</div> </div>							
Material groups									<div style="display: flex; justify-content: space-around;"> <div style="border: 1px solid black; padding: 2px;">P M K</div> <div style="border: 1px solid black; padding: 2px;">P M K</div> <div style="border: 1px solid black; padding: 2px;">P M K</div> <div style="border: 1px solid black; padding: 2px;">P M K</div> </div>							
Hole type									<div style="display: flex; justify-content: space-around;"> <div style="border: 1px solid black; padding: 2px;">< 3d</div> <div style="border: 1px solid black; padding: 2px;">< 3d</div> <div style="border: 1px solid black; padding: 2px;">< 2.5d</div> <div style="border: 1px solid black; padding: 2px;">< 2.5d</div> </div>							
Quality of material									HSSE							
Coating									-							
Chamfer									B / 4-5P							
M Ød ₁	P	l ₁	l ₂	l ₂ R40	l ₃	Ød ₂	a		Norm							
									DIN-376							
									Tol.	ISO2 (6H)	ISO2 (6H)	ISO2 (6H)				ISO2 (6H)
INDEX	D2-111801	D2-118801	D2-511801	D2-518801												
M8	1,25	90	20	15	-	6,0	4,9	6,80	0080	●	●	●	●			
M10	1,50	100	20	17	-	7,0	5,5	8,50	0100	●	●	●	●			
M12	1,75	110	24	18	-	9,0	7,0	10,20	0120	●	●	●	●			
M14	2,00	110	25	20	-	11,0	9,0	12,00	0140	●	●	●	●			
M16	2,00	110	32	20	-	12,0	9,0	14,00	0160	●	●	●	●			
M18	2,50	125	32	25	-	14,0	11,0	15,50	0180	●	●	●	●			
M20	2,50	140	32	25	-	16,0	12,0	17,50	0200	●	●	●	●			
M22	2,50	140	32	25	-	18,0	14,5	19,50	0220	●	●	●	●			
M24	3,00	160	38	30	-	18,0	14,5	21,00	0240	●	●	●	●			
M27	3,00	160	38	30	-	20,0	16,0	24,00	0270	●	○	●	○			
M30	3,50	180	45	35	-	22,0	18,0	26,50	0300	●	○	●	○			
M33	3,50	180	45	35	-	25,0	20,0	29,50	0330	●	○	●	○			
M36	4,00	200	50	40	-	28,0	22,0	32,00	0360	●	○	●	○			
ISO									V _c (m/min)							
P									-							
M									5-15							
K									-							
N									-							
S									-							

1

ISO Metric coarse thread ISO DIN-13									GG					GAL		
									C-TS	C-IK-TS	E-TS	E-IK-TS	E-IKR-TS	C-R15-TS	E-R15-IK-TS	
HSSE PM TS DIN 371 DIN 376																
Material groups									P M K	P M K	P M K	P M K	P M K	P M K	P M K	P M K
Hole type									N S H	N S H	N S H	N S H	N S H	N S H	N S H	N S H
Quality of material									HSSE-PM	HSSE-PM	HSSE-PM	HSSE-PM	HSSE-PM	HSSE-PM	HSSE-PM	
Coating									TS	TS	TS	TS	TS	TS	TS	
Chamfer									C / 2-3P	C / 2-3P	E / 1,5-2P	E / 1,5-2P	E / 1,5-2P	C / 2-3P	E / 1,5-2P	
M Ød ₁	P	l ₁	l ₂	l ₃	Ød ₂	a		DIN-371								
								Norm	6HX	6HX	6HX	6HX	6HX	6HX	6HX	
								Tol.	●	-	○	-	-	●	-	
								INDEX	C2-125501	C4-125551	C2-145501	C4-145551	C4-145561	C2-505601	C4-655651	
M 3	0,50	56	10	18	3,5	2,7	2,50	0030	●	-	○	-	-	●	-	
M 4	0,70	63	12	21	4,5	3,4	3,30	0040	●	-	●	-	-	●	-	
M 5	0,80	70	14	25	6,0	4,9	4,20	0050	●	●	●	●	●	●	○	
M 6	1,00	80	18	30	6,0	4,9	5,00	0060	●	●	●	●	●	●	○	
M 7	1,00	80	18	30	7,0	5,5	6,00	0070	○	○	○	○	○	○	○	
M 8	1,25	90	20	35	8,0	6,2	6,80	0080	●	●	●	●	●	●	○	
M 9	1,25	90	20	35	9,0	7,0	7,80	0090	○	○	○	○	○	○	○	
M10	1,50	100	20	39	10,0	8,0	8,50	0100	●	●	●	●	●	●	○	
M Ød ₁	P	l ₁	l ₂	l ₃	Ød ₂	a		DIN-376								
								Norm	6HX	6HX	6HX	6HX	6HX	6HX	6HX	
								Tol.	●	○	●	○	○	●	○	
								INDEX	D2-125501	D4-125551	D2-145501	D4-145551	D4-145561	D2-505601	D4-655651	
M6	1,00	80	18	-	4,5	3,4	5,00	0060	●	○	●	○	○	●	○	
M8	1,25	90	20	-	6,0	4,9	6,80	0080	●	●	●	●	○	●	○	
M10	1,50	100	20	-	7,0	5,5	8,50	0100	●	●	●	●	○	●	○	
M12	1,75	110	24	-	9,0	7,0	10,20	0120	●	●	●	●	●	●	●	
M14	2,00	110	25	-	11,0	9,0	12,00	0140	●	○	○	○	○	●	○	
M16	2,00	110	32	-	12,0	9,0	14,00	0160	●	●	○	●	●	●	●	
M18	2,50	125	32	-	14,0	11,0	15,50	0180	●	○	○	○	○	●	○	
M20	2,50	140	32	-	16,0	12,0	17,50	0200	●	○	○	○	○	●	○	
ISO									Vc (m/min)							
P									-	-	-	-	-	-	-	
M									-	-	-	-	-	-	-	
K									1-60	5-60	1-60	5-60	5-60	-	-	
N									-	-	-	-	-	10-30	10-30	
S									-	-	-	-	-	-	-	



ISO Metric coarse thread ISO DIN-13									HRC60															
									C-HM-TC	C-1K-HM-TC	D-HM-TC	D-1K-HM-TC												
VHM TC DIN 371 DIN 376																								
Material groups									<table border="1"> <tr><td>P</td><td>M</td><td>K</td><td></td></tr> <tr><td>N</td><td>S</td><td>H</td><td></td></tr> </table>				P	M	K		N	S	H					
P	M	K																						
N	S	H																						
Hole type									<table border="1"> <tr><td></td><td></td><td></td><td></td></tr> <tr><td>< 1,5d</td><td>< 1,5d</td><td>< 1,5d</td><td>< 1,5d</td></tr> </table>								< 1,5d	< 1,5d	< 1,5d	< 1,5d				
< 1,5d	< 1,5d	< 1,5d	< 1,5d																					
Quality of material									VHM															
Coating									TC															
Chamfer									C / 2-3P C / 2-3P D / 4-5P D / 4-5P															
M ød ₁	P	l ₁	l ₂	l ₃	ød ₂	a		Norm	DIN-371															
								Tol.	6HX															
								INDEX	C9-125F01	C9-125F51	C9-135F01	C9-135F51												
M3	0,50	56	5	18	3,5	2,7	2,50	0030	●	-	●	-												
M4	0,70	63	7	21	4,5	3,4	3,30	0040	●	-	●	-												
M5	0,80	70	8	25	6,0	4,9	4,20	0050	●	-	●	-												
M6	1,00	80	10	30	6,0	4,9	5,00	0060	●	●	●	●												
M8	1,25	90	13	35	8,0	6,2	6,80	0080	●	●	●	●												
M10	1,50	100	15	39	10,0	8,0	8,50	0100	●	●	●	●												
M ød ₁	P	l ₁	l ₂	l ₃	ød ₂	a		Norm	DIN-376															
								Tol.	6HX															
								INDEX	D9-125F01	D9-125F51	D9-135F01	D9-135F51												
M12	1,75	110	18	-	9,0	7,0	10,20	0120	●	●	●	●												
M14	2,00	110	20	-	11,0	9,0	12,00	0140	●	●	●	●												
M16	2,00	110	20	-	12,0	9,0	14,00	0160	●	●	●	●												
								ISO	Vc (m/min)															
								P	-	-	-	-												
								M	-	-	-	-												
								K	-	-	-	-												
								N	-	-	-	-												
								S	-	-	-	-												
								H	1-4	1-4	1-4	1-4												

1

ISO Metric coarse thread ISO DIN-13									S-NC						
									B-TC	C-R45-TC	C-R45-IK-TC				
Material groups															
Hole type															
Quality of material									HSSE-PM						
Coating									TC						
Chamfer									B / 4-5P			C / 2-3P			
M Ød ₁	P	l ₁	l ₂	l ₃	Ød ₂	a		Norm							
								DIN-371							
								Tol.	6HX	6HX	6HX				
								INDEX	C4-115301	C4-525301	C4-525351				
M3	0,50	56	5	18	3,5	2,7	2,50	0030	●	●	-				
M4	0,70	63	7	21	4,5	3,4	3,30	0040	●	●	-				
M5	0,80	70	8	25	6,0	4,9	4,20	0050	●	●	●				
M6	1,00	80	10	30	6,0	4,9	5,00	0060	●	●	●				
M8	1,25	90	13	35	8,0	6,2	6,80	0080	●	●	●				
M10	1,50	100	15	39	10,0	8,0	8,50	0100	●	●	●				
M Ød ₁	P	l ₁	l ₂	l ₃	Ød ₂	a		Norm							
								DIN-376							
								Tol.	6HX	6HX	6HX				
								INDEX	D4-115301	D4-525301	D4-525351				
M12	1,75	110	18	-	9,0	7,0	10,20	0120	●	●	●				
M14	2,00	110	20	-	11,0	9,0	12,00	0140	●	●	●				
M16	2,00	110	20	-	12,0	9,0	14,00	0160	●	●	●				
ISO									Vc (m/min)						
P									5-50	5-50	5-60				
M									5-20	5-20	5-30				
K									10-40	10-40	10-60				
N									10-40	10-40	10-60				
S									1-8	1-8	1-8				



ISO Metric coarse thread ISO DIN-13								LH							
HSS DIN 352															
Material groups															
Hole type															
Quality of material								HSS HSS							
Coating															
Chamfer								~3P ~3P							
M $\varnothing d_1$	P	l_1	l_2	l_3	$\varnothing d_2$	a		Norm		DIN-352					
								Tol.	ISO2 (6H)	ISO2 (6H)					
								INDEX	E1-131001	E1-231001					
M3	0,50	40	11	18,0	3,5	2,7	2,5	0030	●	○					
M3,5	0,60	45	13	21,0	4,0	3,0	2,9	0035	●	○					
M4	0,70	45	13	21,0	4,5	3,4	3,3	0040	●	○					
M4,5	0,75	50	16	25,0	6,0	4,9	3,7	0045	○	○					
M5	0,80	52	16	26,0	6,0	4,9	4,2	0050	●	○					
M6	1,00	56	18	27,0	6,0	4,9	5,0	0060	●	○					
M7	1,00	56	18	-	6,0	4,9	6,0	0070	○	○					
M8	1,25	63	20	-	6,0	4,9	6,8	0080	●	○					
M9	1,25	63	20	-	7,0	5,5	7,8	0090	○	○					
M10	1,50	70	22	-	7,0	5,5	8,5	0100	●	○					
M11	1,50	70	22	-	8,0	6,2	9,5	0110	○	○					
M12	1,75	80	24	-	9,0	7,0	10,2	0120	●	○					
M14	2,00	80	26	-	11,0	9,0	12,0	0140	●	○					
M16	2,00	80	27	-	12,0	9,0	14,0	0160	●	○					
M18	2,50	95	30	-	14,0	11,0	15,5	0180	●	○					
M20	2,50	95	32	-	16,0	12,0	17,5	0200	●	○					
M22	2,50	100	32	-	18,0	14,5	19,5	0220	●	○					
M24	3,00	110	34	-	18,0	14,5	21,0	0240	●	○					
M27	3,00	110	36	-	20,0	16,0	24,0	0270	●	○					
M30	3,50	125	40	-	22,0	18,0	26,5	0300	●	○					
M33	3,50	125	40	-	25,0	20,0	29,5	0330	○	○					
M36	4,00	150	50	-	28,0	22,0	32,0	0360	●	○					
M39	4,00	150	50	-	32,0	24,0	35,0	0390	○	○					
M42	4,50	150	56	-	32,0	24,0	37,5	0420	●	○					
M45	4,50	160	58	-	36,0	29,0	40,5	0450	○	○					
M48	5,00	180	65	-	36,0	29,0	43,0	0480	○	○					
M52	5,00	180	65	-	40,0	32,0	47,0	0520	○	○					
M56	5,50	180	70	-	40,0	32,0	50,5	0560	○	○					
M60	5,50	200	70	-	45,0	35,0	54,5	0600	○	○					
M64	6,00	220	75	-	50,0	39,0	58,0	0640	○	○					
M68	6,00	220	75	-	50,0	39,0	62,0	0680	○	○					

- Available from stock
- On request

ISO	Vc (m/min)					
P	5-20	5-20				
M	-	-				
K	-	-				
N	-	-				
S	-	-				

1

ISO Metric coarse thread ISO DIN-13				NUT-TAP					
				lutowane		skręcane			
 <div style="border: 1px solid black; padding: 2px; display: inline-block;">HSSE</div> <div style="background-color: #8B4513; color: white; padding: 2px; display: inline-block; margin-top: 5px;">TS</div>									
Material groups				<div style="display: flex; gap: 5px;"> <div style="border: 1px solid black; padding: 2px;">P</div> <div style="border: 1px solid black; padding: 2px;">M</div> <div style="border: 1px solid black; padding: 2px;">K</div> </div> <div style="display: flex; gap: 5px; margin-top: 2px;"> <div style="border: 1px solid black; padding: 2px;">N</div> <div style="border: 1px solid black; padding: 2px;">S</div> <div style="border: 1px solid black; padding: 2px;">H</div> </div>		<div style="display: flex; gap: 5px;"> <div style="border: 1px solid black; padding: 2px;">P</div> <div style="border: 1px solid black; padding: 2px;">M</div> <div style="border: 1px solid black; padding: 2px;">K</div> </div> <div style="display: flex; gap: 5px; margin-top: 2px;"> <div style="border: 1px solid black; padding: 2px;">N</div> <div style="border: 1px solid black; padding: 2px;">S</div> <div style="border: 1px solid black; padding: 2px;">H</div> </div>			
Hole type				 < 1,5d		 < 1,5d			
Quality of material				HSSE		HSSE			
Coating				TS		TS			
Chamfer				12P		12P			
M	P	Overall dimensions		On request					
M12	1,75	On request	10,2	○	○				
M14	2,00		12,0	○	○				
M16	2,00		14,0	○	○				
M18	2,50		15,5	○	○				
M20	2,50		17,5	○	○				
M22	2,50		19,5	○	○				
M24	3,00		21,0	○	○				
M27	3,00		24,0	○	○				
M30	3,50		26,5	○	○				
M33	3,50		29,5	○	○				
M36	4,00		32,0	○	○				
ISO	Vc (m/min)								
P	5-20	5-20							
M	-	-							
K	-	-							
N	-	-							
S	-	-							



ISO Metric coarse thread ISO DIN-13							NGMf							
 							LH							
Material groups														
Hole type														
Quality of material							HSS	HSS						
Coating														
Chamfer							12P	12P						
M Ød ₁	P	l ₁	l ₂	Ød ₂	a		Norm		NGMf					
							Tol.	INDEX	ISO2 (6H)	ISO2 (6H)				
									F1-151001	F1-251001				
M3	0,5	70	10	2,24	1,8	2,50	0030	○	○					
M4	0,70	90	14	2,8	2,24	3,30	0040	●	●					
M4,5	0,75	100	16	3,15	2,5	3,80	0045	○	○					
M5	0,80	110	16	3,55	2,8	4,20	0050	●	●					
M6	1,00	120	20	4,5	3,55	5,00	0060	●	●					
M7	1,00	120	20	5,6	4,5	6,00	0070	○	○					
M8	1,25	140	25	6,3	5,0	6,80	0080	●	●					
M10	1,50	160	30	8,0	6,3	8,50	0100	●	●					
M12	1,75	180	36	9,0	7,1	10,20	0120	●	●					
M14	2,00	180	40	10,0	8,0	12,00	0140	●	○					
M16	2,00	200	40	12,5	10,0	14,00	0160	●	●					
M18	2,50	200	50	14,0	11,2	15,50	0180	●	○					
M20	2,50	220	50	16,0	12,5	17,50	0200	●	●					
M22	2,50	220	50	18,0	14,0	19,50	0220	●	○					
M24	3,00	250	60	18,0	14,0	21,00	0240	●	●					
M27	3,00	250	60	20,0	16,0	24,00	0270	●	○					
M30	3,50	280	70	22,4	18,0	26,50	0300	●	●					
M33	3,50	280	70	25,0	20,0	29,50	0330	●	●					
M36	4,00	320	80	28,0	22,4	32,00	0360	●	●					

ISO	Vc (m/min)					
P	5-20	5-20				
M	-	-				
K	6-15	6-15				
N	6-15	6-15				
S	-	-				

1

ISO Metric coarse thread ISO DIN-13									KOMBI							
									D-R30							
Material groups									<input type="checkbox"/> P <input type="checkbox"/> M <input type="checkbox"/> K <input type="checkbox"/> N <input type="checkbox"/> S <input type="checkbox"/> H							
Hole type									 < 1,5d							
Quality of material									HSS							
Coating									-							
Chamfer									D/4P							
M Ød ₁	P	l ₁	l ₂	l ₃	Ød ₂	a	 l _d	Norm								
								KOMBI	ISO2 (6H)							
								INDEX	G1-051001							
M 3	0,50	56	11	16	3	2,4	2,5	0030	●							
M 4	0,70	63	14	18	4	3,0	3,3	0040	●							
M 5	0,80	71	18	20	5	3,8	4,2	0050	●							
M 6	1,00	80	22	22	6	4,9	5,0	0060	●							
M 8	1,25	95	25	26	8	6,2	6,8	0080	●							
M 10	1,50	106	31	30	10	8,0	8,5	0100	●							
M 12	1,75	115	35	32	12	9,0	10,2	0120	●							
ISO									Vc (m/min)							
P									5-15							
M									-							
K									-							
N									6-15							
S									-							



ISO Metric coarse thread ISO DIN-13								BIT													
 								D													
Material groups								P	M	K											
								N	S	H											
Hole type								 < 1,5d													
Quality of material								HSS													
Coating								-													
Chamfer								D/4P													
M	P	l ₁	l ₂	l ₃	Ød ₂	Ød ₁	Norm	BIT													
Ød ₁							Tol.	ISO2 (6H)													
							INDEX	G1-031001													
M3	0,50	33	11	-	-	1/4"	2,5	0030	●												
M4	0,70	35	12	-	-	1/4"	3,3	0040	●												
M5	0,80	36	15	-	-	1/4"	4,2	0050	●												
M6	1,00	39	18	-	-	1/4"	5,0	0060	●												
M8	1,25	40	19	-	-	1/4"	6,8	0080	●												
M10	1,50	41	21	-	-	1/4"	8,5	0100	●												
ISO								Vc (m/min)													
P								5-15													
M								-													
K								-													
N								6-15													
S								-													



BIT set p. 256



1

MASTER TAP

ISO Metric fine thread DIN-13									MASTER TAP																																															
									B-HL	B-IKR-HL	C-R45-HL	C-R45-IK-HL	E-R45-HL	E-R45-IK-HL																																										
<div style="display: flex; flex-direction: column; align-items: flex-start;"> <div style="border: 1px solid black; padding: 2px; margin-bottom: 5px;">HSSE PM</div> <div style="border: 1px solid black; padding: 2px; margin-bottom: 5px;">HL</div> <div style="border: 1px solid black; padding: 2px;">DIN 371</div> </div>																																																								
Material groups									<table border="1"> <tr><td>P</td><td>M</td><td>K</td></tr> <tr><td>N</td><td>S</td><td>H</td></tr> </table>		P	M	K	N	S	H	<table border="1"> <tr><td>P</td><td>M</td><td>K</td></tr> <tr><td>N</td><td>S</td><td>H</td></tr> </table>		P	M	K	N	S	H	<table border="1"> <tr><td>P</td><td>M</td><td>K</td></tr> <tr><td>N</td><td>S</td><td>H</td></tr> </table>		P	M	K	N	S	H	<table border="1"> <tr><td>P</td><td>M</td><td>K</td></tr> <tr><td>N</td><td>S</td><td>H</td></tr> </table>		P	M	K	N	S	H	<table border="1"> <tr><td>P</td><td>M</td><td>K</td></tr> <tr><td>N</td><td>S</td><td>H</td></tr> </table>		P	M	K	N	S	H	<table border="1"> <tr><td>P</td><td>M</td><td>K</td></tr> <tr><td>N</td><td>S</td><td>H</td></tr> </table>		P	M	K	N	S	H
P	M	K																																																						
N	S	H																																																						
P	M	K																																																						
N	S	H																																																						
P	M	K																																																						
N	S	H																																																						
P	M	K																																																						
N	S	H																																																						
P	M	K																																																						
N	S	H																																																						
P	M	K																																																						
N	S	H																																																						
Hole type																																																								
Quality of material									HSSE-PM		HSSE-PM		HSSE-PM		HSSE-PM		HSSE-PM		HSSE-PM																																					
Coating									HL		HL		HL		HL		HL		HL																																					
Chamfer									B / 4-5P		B / 4-5P		C / 2-3P		C / 2-3P		E / 1,5-2P		E / 1,5-2P																																					
MF	ød ₁	P	l ₁	l ₂	l ₃	ød ₂	a		Norm																																															
									DIN-371						Tol.	6HX	6HX	6HX	6HX	6HX	6HX																																			
									INDEX	C4-118M01	C4-118M61	C4-528M01	C4-528M51	C4-718M01	C4-718M51																																									
M3x0,35		0,35	56	5	18	3,5	2,7	2,65	0031	●	-	●	-	○	-																																									
M3,5x0,35		0,35	56	5	20	4,0	3,0	3,15	0036	●	-	●	-	○	-																																									
M4x0,5		0,50	63	7	21	4,5	3,4	3,50	0041	●	-	●	-	○	-																																									
M5x0,5		0,50	70	8	25	6,0	4,9	4,50	0051	●	○	●	○	○	○																																									
M6x0,5		0,50	80	10	30	6,0	4,9	5,50	0061	●	○	●	○	○	○																																									
M6x0,75		0,75	80	10	30	6,0	4,9	5,20	0062	●	○	●	○	○	○																																									
M8x0,75		0,75	80	10	30	8,0	6,2	7,20	0082	●	○	●	○	○	○																																									
M8x1		1,00	90	13	35	8,0	6,2	7,00	0083	●	●	●	●	●	●																																									
M10x0,75		0,75	90	13	35	10,0	8,0	9,20	0102	●	○	●	○	○	○																																									
M10x1		1,00	90	13	35	10,0	8,0	9,00	0103	●	●	●	●	●	●																																									
M10x1,25		1,25	100	15	39	10,0	8,0	8,80	0104	●	○	●	○	○	○																																									
									Vc (m/min)																																															
									ISO	5-40	5-50	5-40	5-50	5-40	5-50																																									
									P	5-40	5-50	5-40	5-50	5-40	5-50																																									
									M	5-15	5-25	5-15	5-25	5-15	5-25																																									
									K	10-30	10-50	10-30	10-50	10-30	10-50																																									
									N	10-30	10-50	10-30	10-50	10-30	10-50																																									
									S	1-8	1-8	1-8	1-8	1-8	1-8																																									



ISO Metric fine thread DIN-13									MASTER TAP						
									B-HL	B-IKR-HL	C-R45-HL	C-R45-IK-HL	E-R45-HL	E-R45-IK-HL	
<div style="display: flex; flex-direction: column; align-items: flex-start;"> <div style="border: 1px solid black; padding: 2px; margin-bottom: 5px;">HSSE PM</div> <div style="border: 1px solid black; padding: 2px; margin-bottom: 5px;">HL</div> <div style="border: 1px solid black; padding: 2px;">DIN 374</div> </div>									<div style="display: flex; justify-content: space-around;"> <div style="text-align: center;">P M K N S H</div> <div style="text-align: center;">P M K N S H</div> <div style="text-align: center;">P M K N S H</div> <div style="text-align: center;">P M K N S H</div> <div style="text-align: center;">P M K N S H</div> <div style="text-align: center;">P M K N S H</div> </div>						
Material groups															
Hole type									<div style="display: flex; justify-content: space-around;"> <div style="text-align: center;"> < 3d</div> <div style="text-align: center;"> < 3d</div> <div style="text-align: center;"> < 2.5d</div> <div style="text-align: center;"> < 2.5d</div> <div style="text-align: center;"> < 2.5d</div> <div style="text-align: center;"> < 2.5d</div> </div>						
Quality of material									HSSE-PM HSSE-PM HSSE-PM HSSE-PM HSSE-PM HSSE-PM						
Coating									HL HL HL HL HL HL						
Chamfer									B / 4-5P B / 4-5P C / 2-3P C / 2-3P E / 1,5-2P E / 1,5-2P						
MF Ø _{d1}	P	l ₁	l ₂	l ₃	Ø _{d2}	a		Norm							
								DIN-374							
								Tol.	6HX	6HX	6HX	6HX	6HX	6HX	
									INDEX	D4-118M01	D4-118M61	D4-528M01	D4-528M51	D4-718M01	D4-718M51
M8x1	1,00	90	10	-	6,0	4,9	7,00	0083	●	●	●	●	●	○	
M10x0,75	0,75	90	10	-	7,0	5,5	9,20	0102	○	○	○	○	○	○	
M10x1	1,00	90	10	-	7,0	5,5	9,00	0103	●	●	●	●	●	○	
M10x1,25	1,25	100	15	-	7,0	5,5	8,80	0104	○	○	○	○	○	○	
M12x1	1,00	100	10	-	9,0	7,0	11,00	0123	●	○	●	○	○	○	
M12x1,25	1,25	100	15	-	9,0	7,0	10,80	0124	●	○	●	○	○	○	
M12x1,5	1,50	100	15	-	9,0	7,0	10,50	0125	●	●	●	●	●	○	
M14x1	1,00	100	10	-	11,0	9,0	13,00	0143	○	○	○	○	○	○	
M14x1,25	1,25	100	15	-	11,0	9,0	12,80	0144	○	○	○	○	○	○	
M14x1,5	1,50	100	15	-	11,0	9,0	12,50	0145	●	●	●	●	●	○	
M15x1	1,00	100	10	-	12,0	9,0	14,00	0153	○	○	○	○	○	○	
M16x1	1,00	100	10	-	12,0	9,0	15,00	0163	○	○	○	○	○	○	
M16x1,5	1,50	100	15	-	12,0	9,0	14,50	0165	●	●	●	●	●	○	
M18x1	1,00	110	13	-	14,0	11,0	17,00	0183	○	○	○	○	○	○	
M18x1,5	1,50	110	17	-	14,0	11,0	16,50	0185	●	○	●	○	○	○	
M18x2	2,00	125	20	-	14,0	11,0	16,00	0186	○	○	○	○	○	○	
M20x1	1,00	125	13	-	16,0	12,0	19,00	0203	○	○	○	○	○	○	
M20x1,5	1,50	125	17	-	16,0	12,0	18,50	0205	●	○	●	○	○	○	
M20x2	2,00	140	20	-	16,0	12,0	18,00	0206	○	○	○	○	○	○	
M22x1	1,00	125	13	-	18,0	14,5	21,00	0223	○	○	○	○	○	○	
M22x1,5	1,50	125	17	-	18,0	14,5	20,50	0225	●	○	●	○	○	○	
M22x2	2,00	140	20	-	18,0	14,5	20,00	0226	○	○	○	○	○	○	
M24x1	1,00	140	13	-	18,0	14,5	23,00	0243	○	○	○	○	○	○	
M24x1,5	1,50	140	20	-	18,0	14,5	22,50	0245	●	○	●	○	○	○	
M24x2	2,00	140	20	-	18,0	14,5	22,00	0246	○	○	○	○	○	○	

ISO	Vc (m/min)					
P	5-40	5-50	5-40	5-50	5-40	5-50
M	5-15	5-25	5-15	5-25	5-15	5-25
K	10-30	10-50	10-30	10-50	10-30	10-50
N	10-30	10-50	10-30	10-50	10-30	10-50
S	1-8	1-8	1-8	1-8	1-8	1-8

MASTER TAP

1

ISO Metric fine thread DIN-13

800X

C-TN2 B-TN2 C-R40-TN2



HSSE

TN2

DIN 371

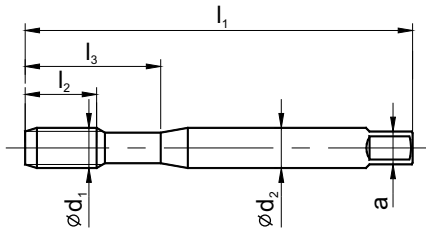

Material groups



Hole type



Quality of material

HSSE HSSE HSSE

Coating

TN2 TN2 TN2

Chamfer

C / 2-3P B / 4-5P C / 2-3P

MF ød ₁	P	l ₁	l ₂	l ₂ R40	l ₃	ød ₂	a		Norm			DIN-371			
									Tol.			ISO2 (6H)			
									INDEX			C2-123X01	C2-113X01	C2-513X01	
M4x0,5	0,50	63	12	7	21	4,5	3,4	3,50	0041	○	○	○			
M5x0,5	0,50	70	14	8	25	6,0	4,9	4,50	0051	○	○	○			
M6x0,75	0,75	80	14	10	30	6,0	4,9	5,20	0062	○	○	○			
M8x0,75	0,75	80	18	10	30	8,0	6,2	7,20	0082	○	○	○			
M8x1	1,00	90	20	13	35	8,0	6,2	7,00	0083	●	●	●			
M10x0,75	0,75	90	20	13	35	10,0	8,0	9,20	0102	○	○	○			
M10x1	1,00	90	20	13	35	10,0	8,0	9,00	0103	●	●	●			
M10x1,25	1,25	100	20	15	39	10,0	8,0	8,80	0104	○	●	●			

ISO	V _c (m/min)		
P	5-35	5-35	5-35
M	5-15	5-15	5-15
K	5-25	5-25	5-25
N	10-30	10-30	10-30
S	-	-	-

800X

ISO Metric fine thread DIN-13										800X																														
										C-TN2	B-TN2	C-R40-TN2																												
<div style="display: flex; gap: 5px;"> <div style="border: 1px solid black; padding: 2px;">HSSE</div> <div style="border: 1px solid black; padding: 2px;">TN2</div> <div style="border: 1px solid black; padding: 2px;">DIN 374</div> </div>										<div style="display: flex; gap: 5px;"> <div style="border: 1px solid black; padding: 2px;">P</div><div style="border: 1px solid black; padding: 2px;">M</div><div style="border: 1px solid black; padding: 2px;">K</div> </div>																														
Material groups										<div style="display: flex; gap: 5px;"> <div style="border: 1px solid black; padding: 2px;">P</div><div style="border: 1px solid black; padding: 2px;">M</div><div style="border: 1px solid black; padding: 2px;">K</div> </div>																														
Hole type										<div style="display: flex; gap: 5px;"> <div style="border: 1px solid black; padding: 2px;">N</div><div style="border: 1px solid black; padding: 2px;">S</div><div style="border: 1px solid black; padding: 2px;">H</div> </div>																														
Quality of material										<div style="display: flex; gap: 5px;"> <div style="border: 1px solid black; padding: 2px;">N</div><div style="border: 1px solid black; padding: 2px;">S</div><div style="border: 1px solid black; padding: 2px;">H</div> </div>																														
Coating										<div style="display: flex; gap: 5px;"> <div style="border: 1px solid black; padding: 2px;">< 1.5d</div> <div style="border: 1px solid black; padding: 2px;">< 3d</div> <div style="border: 1px solid black; padding: 2px;">< 2.5d</div> </div>																														
Chamfer										<div style="display: flex; gap: 5px;"> <div style="border: 1px solid black; padding: 2px;">HSSE</div> <div style="border: 1px solid black; padding: 2px;">HSSE</div> <div style="border: 1px solid black; padding: 2px;">HSSE</div> </div>																														
										<div style="display: flex; gap: 5px;"> <div style="border: 1px solid black; padding: 2px;">TN2</div> <div style="border: 1px solid black; padding: 2px;">TN2</div> <div style="border: 1px solid black; padding: 2px;">TN2</div> </div>																														
										<div style="display: flex; gap: 5px;"> <div style="border: 1px solid black; padding: 2px;">C / 2-3P</div> <div style="border: 1px solid black; padding: 2px;">B / 4-5P</div> <div style="border: 1px solid black; padding: 2px;">C / 2-3P</div> </div>																														
MF Ød ₁	P	l ₁	l ₂	R ₄₀	l ₃	Ød ₂	a		Norm			DIN-374																												
									ISO2 (6H)			ISO2 (6H)			ISO2 (6H)																									
									INDEX			INDEX			INDEX																									
M8x1	1,00	90	20	10	-	6,0	4,9	7,00	0083	●	●	●																												
M9x1	1,00	90	20	10	-	7,0	5,5	8,00	0093	○	○	○																												
M10x0,75	0,75	90	18	10	-	7,0	5,5	9,20	0102	●	●	●																												
M10x1	1,00	90	20	10	-	7,0	5,5	9,00	0103	●	●	●																												
M10x1,25	1,25	100	20	15	-	7,0	5,5	8,80	0104	●	●	●																												
M11x1	1,00	90	20	10	-	8,0	6,2	10,00	0113	○	○	○																												
M12x1	1,00	100	20	10	-	9,0	7,0	11,00	0123	●	●	●																												
M12x1,25	1,25	100	20	15	-	9,0	7,0	10,80	0124	●	●	●																												
M12x1,5	1,50	100	20	15	-	9,0	7,0	10,50	0125	●	●	●																												
M14x1	1,00	100	20	10	-	11,0	9,0	13,00	0143	●	●	●																												
M14x1,25	1,25	100	20	15	-	11,0	9,0	12,80	0144	●	●	●																												
M14x1,5	1,50	100	20	15	-	11,0	9,0	12,50	0145	●	●	●																												
M15x1	1,00	100	20	10	-	12,0	9,0	14,00	0153	○	○	○																												
M16x1	1,00	100	20	10	-	12,0	9,0	15,00	0163	●	●	●																												
M16x1,5	1,50	100	20	15	-	12,0	9,0	14,50	0165	●	●	●																												
M18x1	1,00	110	24	13	-	14,0	11,0	17,00	0183	○	○	○																												
M18x1,5	1,50	110	24	17	-	14,0	11,0	16,50	0185	●	●	●																												
M18x2	2,00	125	27	20	-	14,0	11,0	16,00	0186	●	●	●																												
M20x1	1,00	125	24	13	-	16,0	12,0	19,00	0203	○	○	○																												
M20x1,5	1,50	125	24	17	-	16,0	12,0	18,50	0205	●	●	●																												
M20x2	2,00	140	27	20	-	16,0	12,0	18,00	0206	●	●	●																												
M22x1	1,00	125	24	13	-	18,0	14,5	21,00	0223	○	○	○																												
M22x1,5	1,50	125	24	17	-	18,0	14,5	20,50	0225	●	●	●																												
M22x2	2,00	140	27	20	-	18,0	14,5	20,00	0226	●	●	●																												
M24x1	1,00	140	27	13	-	18,0	14,5	23,00	0243	○	○	○																												
M24x1,5	1,50	140	27	20	-	18,0	14,5	22,50	0245	●	●	●																												
M24x2	2,00	140	27	20	-	18,0	14,5	22,00	0246	●	●	●																												
M25x1,5	1,50	140	27	20	-	18,0	14,5	23,50	0255	○	○	○																												
M26x1,5	1,50	140	27	20	-	18,0	14,5	24,50	0265	○	○	○																												
M27x1,5	1,50	140	27	20	-	20,0	16,0	25,50	0275	●	●	●																												
M27x2	2,00	140	27	20	-	20,0	16,0	25,00	0276	●	●	●																												
M28x1,5	1,50	140	27	20	-	20,0	16,0	26,50	0285	○	○	○																												
<ul style="list-style-type: none"> ● Available from stock ○ On request 										<table border="1"> <thead> <tr> <th>ISO</th> <th colspan="3">Vc (m/min)</th> </tr> </thead> <tbody> <tr> <td>P</td> <td>5-35</td> <td>5-35</td> <td>5-35</td> </tr> <tr> <td>M</td> <td>5-15</td> <td>5-15</td> <td>5-15</td> </tr> <tr> <td>K</td> <td>5-25</td> <td>5-25</td> <td>5-25</td> </tr> <tr> <td>N</td> <td>10-30</td> <td>10-30</td> <td>10-30</td> </tr> <tr> <td>S</td> <td>-</td> <td>-</td> <td>-</td> </tr> </tbody> </table>			ISO	Vc (m/min)			P	5-35	5-35	5-35	M	5-15	5-15	5-15	K	5-25	5-25	5-25	N	10-30	10-30	10-30	S	-	-	-				
ISO	Vc (m/min)																																							
P	5-35	5-35	5-35																																					
M	5-15	5-15	5-15																																					
K	5-25	5-25	5-25																																					
N	10-30	10-30	10-30																																					
S	-	-	-																																					

1

800X

ISO Metric fine thread DIN-13										800X							
										C-TN2	B-TN2	C-R40-TN2					
Material groups										P M K N S H	P M K N S H	P M K N S H					
Hole type																	
Quality of material										HSSE	HSSE	HSSE					
Coating										TN2	TN2	TN2					
Chamfer										C / 2-3P	B / 4-5P	C / 2-3P					
MF Ød ₁	P	l ₁	l ₂	l ₂ R40	l ₃	Ød ₂	a		Norm		DIN-374						
									Tol.	ISO2 (6H)	ISO2 (6H)	ISO2 (6H)					
									INDEX	D2-123X01	D2-113X01	D2-513X01					
M28x2	2,0	140	27	20	-	20,0	16,0	26,00	0286	○	○	○					
M30x1,5	1,5	150	27	22	-	22,0	18,0	28,50	0305	●	●	●					
M30x2	2,0	150	27	22	-	22,0	18,0	28,00	0306	●	●	●					
M32x1,5	1,5	150	27	22	-	22,0	18,0	30,50	0325	○	○	○					
M32x2	2,0	150	27	22	-	22,0	18,0	30,00	0326	○	○	○					
M33x1,5	1,5	160	30	22	-	25,0	20,0	31,50	0335	○	○	○					
M33x2	2,0	160	30	24	-	25,0	20,0	31,00	0336	○	○	○					
M34x1,5	1,5	170	30	22	-	28,0	22,0	32,50	0345	○	○	○					
M35x1,5	1,5	170	30	22	-	28,0	22,0	33,50	0355	○	○	○					
M36x1,5	1,5	170	30	22	-	28,0	22,0	34,50	0365	○	○	○					
M36x2	2,0	170	30	24	-	28,0	22,0	34,00	0366	○	○	○					
M36x3	3,0	200	50	30	-	28,0	22,0	33,00	0367	○	○	○					
M38x1,5	1,5	170	30	24	-	28,0	22,0	36,50	0385	○	○	○					
M39x1,5	1,5	170	30	25	-	32,0	24,0	37,50	0395	○	○	○					
M39x2	2,0	170	30	25	-	32,0	24,0	37,00	0396	○	○	○					
M39x3	3,0	200	50	30	-	32,0	24,0	36,00	0397	○	○	○					
M40x1,5	1,5	170	30	25	-	32,0	24,0	38,50	0405	○	○	○					
M40x2	2,0	170	30	25	-	32,0	24,0	38,00	0406	○	○	○					
M42x1,5	1,5	170	30	25	-	32,0	24,0	40,50	0425	○	○	○					
M42x2	2,0	170	30	25	-	32,0	24,0	40,00	0426	○	○	○					
M42x3	3,0	200	50	30	-	32,0	24,0	39,00	0427	○	○	○					
M45x1,5	1,5	180	32	27	-	36,0	29,0	43,50	0455	○	○	○					
M45x2	2,0	180	32	27	-	36,0	29,0	43,00	0456	○	○	○					
M45x3	3,0	200	50	30	-	36,0	29,0	42,00	0457	○	○	○					
M48x1,5	1,5	190	32	27	-	36,0	29,0	46,50	0485	○	○	○					
M48x2	2,0	190	32	27	-	36,0	29,0	46,00	0486	○	○	○					
M48x3	3,0	225	50	33	-	36,0	29,0	45,00	0487	○	○	○					
M50x1,5	1,5	190	32	27	-	36,0	29,0	48,50	0505	○	○	○					
M50x2	2,0	190	32	27	-	36,0	29,0	48,00	0506	○	○	○					
M52x1,5	1,5	190	32	27	-	40,0	32,0	50,50	0525	○	○	○					
M52x2	2,0	190	32	27	-	40,0	32,0	50,00	0526	○	○	○					
M52x3	3,0	225	50	33	-	40,0	32,0	49,00	0527	○	○	○					

- Available from stock
- On request

ISO	Vc (m/min)					
P	5-35	5-35	5-35			
M	5-15	5-15	5-15			
K	5-25	5-25	5-25			
N	10-30	10-30	10-30			
S	-	-	-			



ISO Metric fine thread DIN-13										800																							
										C	B	C-R40																					
Material groups										<table border="1"> <tr><td>P</td><td>M</td><td>K</td></tr> <tr><td>N</td><td>S</td><td>H</td></tr> </table>	P	M	K	N	S	H	<table border="1"> <tr><td>P</td><td>M</td><td>K</td></tr> <tr><td>N</td><td>S</td><td>H</td></tr> </table>	P	M	K	N	S	H	<table border="1"> <tr><td>P</td><td>M</td><td>K</td></tr> <tr><td>N</td><td>S</td><td>H</td></tr> </table>	P	M	K	N	S	H			
P	M	K																															
N	S	H																															
P	M	K																															
N	S	H																															
P	M	K																															
N	S	H																															
Hole type																																	
Quality of material										HSSE	HSSE	HSSE																					
Coating																																	
Chamfer										C / 2-3P	B / 4-5P	C / 2-3P																					
MF	Ød ₁	P	l ₁	l ₂	l ₂ R40	l ₃	Ød ₂	a		Norm			DIN-371																				
										Tol.	ISO2 (6H)	ISO2 (6H)	ISO2 (6H)																				
										INDEX	C2-121101	C2-111101	C2-511101																				
M3x0,35	0,35	56	10	5	18	3,5	2,7	2,65	0031	●	●	●																					
M3,5x0,35	0,35	56	10	5	20	4,0	3,0	3,15	0036	●	●	●																					
M4x0,5	0,50	63	12	7	21	4,5	3,4	3,50	0041	●	●	●																					
M5x0,5	0,50	70	14	8	25	6,0	4,9	4,50	0051	●	●	●																					
M6x0,75	0,75	80	14	10	30	6,0	4,9	5,20	0062	●	●	●																					
M8x0,75	0,75	80	18	10	30	8,0	6,2	7,20	0082	●	●	●																					
M8x1	1,00	90	20	13	35	8,0	6,2	7,00	0083	●	●	●																					
M10x0,75	0,75	90	20	13	35	10,0	8,0	9,20	0102	●	●	●																					
M10x1	1,00	90	20	13	35	10,0	8,0	9,00	0103	●	●	●																					
M10x1,25	1,25	100	20	15	39	10,0	8,0	8,80	0104	●	●	●																					
										ISO			Vc (m/min)																				
										P	5-20	5-20	5-20																				
										M	5-10	5-10	5-10																				
										K	5-15	5-15	5-15																				
										N	5-25	5-25	5-25																				
										S	-	-	-																				

ISO Metric fine thread DIN-13										800							
<p>HSSE DIN 374</p>										C	B	C-R40					
Material groups										P M K N S H	P M K N S H	P M K N S H					
Hole type																	
Quality of material										HSSE	HSSE	HSSE					
Coating																	
Chamfer										C / 2-3P	B / 4-5P	C / 2-3P					
MF Ød ₁	P	l ₁	l ₂	l ₂ R40 R45	l ₃	Ød ₂	a		Norm		DIN-374						
									Tol.	INDEX	ISO2 (6H)	ISO2 (6H)	ISO2 (6H)				
M8x1	1,00	90	20	10	-	6,0	4,9	7,00	0083	●	●	●					
M9x1	1,00	90	20	10	-	7,0	5,5	8,00	0093	○	○	○					
M10x0,75	0,75	90	18	10	-	7,0	5,5	9,20	0102	●	●	●					
M10x1	1,00	90	20	10	-	7,0	5,5	9,00	0103	●	●	●					
M10x1,25	1,25	100	20	15	-	7,0	5,5	8,80	0104	●	●	●					
M11x1	1,00	90	20	10	-	8,0	6,2	10,00	0113	○	○	○					
M12x1	1,00	100	20	10	-	9,0	7,0	11,00	0123	●	●	●					
M12x1,25	1,25	100	20	15	-	9,0	7,0	10,80	0124	●	●	●					
M12x1,5	1,50	100	20	15	-	9,0	7,0	10,50	0125	●	●	●					
M14x1	1,00	100	20	10	-	11,0	9,0	13,00	0143	●	●	●					
M14x1,25	1,25	100	20	15	-	11,0	9,0	12,80	0144	●	●	●					
M14x1,5	1,50	100	20	15	-	11,0	9,0	12,50	0145	●	●	●					
M15x1	1,00	100	20	10	-	12,0	9,0	14,00	0153	○	○	○					
M16x1	1,00	100	20	10	-	12,0	9,0	15,00	0163	●	●	●					
M16x1,5	1,50	100	20	15	-	12,0	9,0	14,50	0165	●	●	●					
M18x1	1,00	110	24	13	-	14,0	11,0	17,00	0183	○	○	○					
M18x1,5	1,50	110	24	17	-	14,0	11,0	16,50	0185	●	●	●					
M18x2	2,00	125	27	20	-	14,0	11,0	16,00	0186	●	●	●					
M20x1	1,00	125	24	13	-	16,0	12,0	19,00	0203	○	○	○					
M20x1,5	1,50	125	24	17	-	16,0	12,0	18,50	0205	●	●	●					
M20x2	2,00	140	27	20	-	16,0	12,0	18,00	0206	●	●	●					
M22x1	1,00	125	24	13	-	18,0	14,5	21,00	0223	○	○	○					
M22x1,5	1,50	125	24	17	-	18,0	14,5	20,50	0225	●	●	●					
M22x2	2,00	140	27	20	-	18,0	14,5	20,00	0226	●	●	●					
M24x1	1,00	140	27	13	-	18,0	14,5	23,00	0243	○	○	○					
M24x1,5	1,50	140	27	20	-	18,0	14,5	22,50	0245	●	●	●					
M24x2	2,00	140	27	20	-	18,0	14,5	22,00	0246	●	●	●					
M25x1,5	1,50	140	27	20	-	18,0	14,5	23,50	0255	○	○	○					
M26x1,5	1,50	140	27	20	-	18,0	14,5	24,50	0265	○	○	○					
M27x1,5	1,50	140	27	20	-	20,0	16,0	25,50	0275	●	●	●					
M27x2	2,00	140	27	20	-	20,0	16,0	25,00	0276	●	●	●					
M28x1,5	1,50	140	27	20	-	20,0	16,0	26,50	0285	○	○	○					

● Available from stock	ISO				Vc (m/min)			
○ On request	P	5-20	5-20	5-20				
	M	5-10	5-10	5-10				
	K	5-15	5-15	5-15				
	N	5-25	5-25	5-25				
	S	-	-	-				



ISO Metric fine thread DIN-13										800																								
										C	B	C-R40																						
Material groups										<table border="1"> <tr><td>P</td><td>M</td><td>K</td></tr> <tr><td>N</td><td>S</td><td>H</td></tr> </table>	P	M	K	N	S	H	<table border="1"> <tr><td>P</td><td>M</td><td>K</td></tr> <tr><td>N</td><td>S</td><td>H</td></tr> </table>	P	M	K	N	S	H	<table border="1"> <tr><td>P</td><td>M</td><td>K</td></tr> <tr><td>N</td><td>S</td><td>H</td></tr> </table>	P	M	K	N	S	H				
P	M	K																																
N	S	H																																
P	M	K																																
N	S	H																																
P	M	K																																
N	S	H																																
Hole type																																		
Quality of material										HSSE	HSSE	HSSE																						
Coating																																		
Chamfer										C / 2-3P	B / 4-5P	C / 2-3P																						
MF Ød ₁	P	l ₁	l ₂	R ₄₀	l ₃	Ød ₂	a		Norm			DIN-374																						
									Tol.			ISO2 (6H)	ISO2 (6H)	ISO2 (6H)																				
									INDEX			D2-121101	D2-111101	D2-511101																				
M28x2	2,0	140	27	20	-	20,0	16,0	26,00	0286	○	○	○																						
M30x1,5	1,5	150	27	22	-	22,0	18,0	28,50	0305	●	●	●																						
M30x2	2,0	150	27	22	-	22,0	18,0	28,00	0306	●	●	●																						
M32x1,5	1,5	150	27	22	-	22,0	18,0	30,50	0325	○	○	○																						
M32x2	2,0	150	27	22	-	22,0	18,0	30,00	0326	○	○	○																						
M33x1,5	1,5	160	30	22	-	25,0	20,0	31,50	0335	●	●	●																						
M33x2	2,0	160	30	24	-	25,0	20,0	31,00	0336	●	●	●																						
M34x1,5	1,5	170	30	22	-	28,0	22,0	32,50	0345	○	○	○																						
M35x1,5	1,5	170	30	22	-	28,0	22,0	33,50	0355	○	○	○																						
M36x1,5	1,5	170	30	22	-	28,0	22,0	34,50	0365	●	●	●																						
M36x2	2,0	170	30	24	-	28,0	22,0	34,00	0366	●	●	●																						
M36x3	3,0	200	50	30	-	28,0	22,0	33,00	0367	○	○	○																						
M38x1,5	1,5	170	30	24	-	28,0	22,0	36,50	0385	○	○	○																						
M39x1,5	1,5	170	30	25	-	32,0	24,0	37,50	0395	○	○	○																						
M39x2	2,0	170	30	25	-	32,0	24,0	37,00	0396	○	○	○																						
M39x3	3,0	200	50	30	-	32,0	24,0	36,00	0397	○	○	○																						
M40x1,5	1,5	170	30	25	-	32,0	24,0	38,50	0405	○	○	○																						
M40x2	2,0	170	30	25	-	32,0	24,0	38,00	0406	○	○	○																						
M42x1,5	1,5	170	30	25	-	32,0	24,0	40,50	0425	○	○	○																						
M42x2	2,0	170	30	25	-	32,0	24,0	40,00	0426	○	○	○																						
M42x3	3,0	200	50	30	-	32,0	24,0	39,00	0427	○	○	○																						
M45x1,5	1,5	180	32	27	-	36,0	29,0	43,50	0455	○	○	○																						
M45x2	2,0	180	32	27	-	36,0	29,0	43,00	0456	○	○	○																						
M45x3	3,0	200	50	30	-	36,0	29,0	42,00	0457	○	○	○																						
M48x1,5	1,5	190	32	27	-	36,0	29,0	46,50	0485	○	○	○																						
M48x2	2,0	190	32	27	-	36,0	29,0	46,00	0486	○	○	○																						
M48x3	3,0	225	50	33	-	36,0	29,0	45,00	0487	○	○	○																						
M50x1,5	1,5	190	32	27	-	36,0	29,0	48,50	0505	○	○	○																						
M50x2	2,0	190	32	27	-	36,0	29,0	48,00	0506	○	○	○																						
M52x1,5	1,5	190	32	27	-	40,0	32,0	50,50	0525	○	○	○																						
M52x2	2,0	190	32	27	-	40,0	32,0	50,00	0526	○	○	○																						
M52x3	3,0	225	50	33	-	40,0	32,0	49,00	0527	○	○	○																						

- Available from stock
- On request

ISO	Vc (m/min)					
P	5-20	5-20	5-20			
M	5-10	5-10	5-10			
K	5-15	5-15	5-15			
N	5-25	5-25	5-25			
S	-	-	-			

1

ISO Metric fine thread DIN-13										<i>FAN-I200</i>		<i>I400-HT</i>																																																																																																																																																																														
										B-TS	C-R40-TS	C-TS	B-TS	C-R15-TS																																																																																																																																																																												
<div style="display: flex; flex-direction: column; align-items: center;"> <div style="border: 1px solid black; padding: 2px; margin-bottom: 5px;">HSSE PM</div> <div style="border: 1px solid black; padding: 2px; margin-bottom: 5px;">TS</div> <div style="border: 1px solid black; padding: 2px;">DIN 371</div> </div>										<div style="display: flex; justify-content: space-around;"> PMK </div> <div style="display: flex; justify-content: space-around; font-size: small;"> NSH </div>		<div style="display: flex; justify-content: space-around;"> PMK </div> <div style="display: flex; justify-content: space-around; font-size: small;"> NSH </div>		<div style="display: flex; justify-content: space-around;"> PMK </div> <div style="display: flex; justify-content: space-around; font-size: small;"> NSH </div>		<div style="display: flex; justify-content: space-around;"> PMK </div> <div style="display: flex; justify-content: space-around; font-size: small;"> NSH </div>		<div style="display: flex; justify-content: space-around;"> PMK </div> <div style="display: flex; justify-content: space-around; font-size: small;"> NSH </div>																																																																																																																																																																								
Material groups																																																																																																																																																																																										
Hole type																																																																																																																																																																																										
Quality of material										HSSE-PM		HSSE-PM		HSSE-PM																																																																																																																																																																												
Coating										TS		TS		TS																																																																																																																																																																												
Chamfer										B / 4-5P		C / 2-3P		C / 2-3P																																																																																																																																																																												
<table border="1" style="width: 100%; border-collapse: collapse;"> <thead> <tr> <th rowspan="2">MF Ød₁</th> <th rowspan="2">P</th> <th rowspan="2">l₁</th> <th rowspan="2">l₂</th> <th rowspan="2">l₂ R40</th> <th rowspan="2">l₃</th> <th rowspan="2">Ød₂</th> <th rowspan="2">a</th> <th rowspan="2"></th> <th colspan="5">Norm</th> </tr> <tr> <th colspan="5">DIN-371</th> </tr> <tr> <th colspan="10"></th> <th>Tol.</th> <th>ISO2 (6H)</th> <th>ISO2 (6H)</th> <th>6HX</th> <th>6HX</th> <th>6HX</th> </tr> <tr> <th colspan="10"></th> <th>INDEX</th> <th>C4-115001</th> <th>C4-565001</th> <th>C4-12G901</th> <th>C4-11G901</th> <th>C4-50G901</th> </tr> </thead> <tbody> <tr> <td>M4x0,5</td><td>0,50</td><td>63</td><td>12</td><td>7</td><td>21</td><td>4,5</td><td>3,4</td><td>3,50</td><td>0041</td><td>○</td><td>○</td><td>○</td><td>○</td><td>○</td></tr> <tr> <td>M5x0,5</td><td>0,50</td><td>70</td><td>14</td><td>8</td><td>25</td><td>6,0</td><td>4,9</td><td>4,50</td><td>0051</td><td>○</td><td>○</td><td>○</td><td>○</td><td>○</td></tr> <tr> <td>M6x0,75</td><td>0,75</td><td>80</td><td>14</td><td>10</td><td>30</td><td>6,0</td><td>4,9</td><td>5,20</td><td>0062</td><td>○</td><td>○</td><td>○</td><td>○</td><td>○</td></tr> <tr> <td>M8x0,75</td><td>0,75</td><td>80</td><td>18</td><td>10</td><td>30</td><td>8,0</td><td>6,2</td><td>7,20</td><td>0082</td><td>○</td><td>○</td><td>○</td><td>○</td><td>○</td></tr> <tr> <td>M8x1</td><td>1,00</td><td>90</td><td>20</td><td>13</td><td>35</td><td>8,0</td><td>6,2</td><td>7,00</td><td>0083</td><td>●</td><td>●</td><td>●</td><td>●</td><td>●</td></tr> <tr> <td>M10x0,75</td><td>0,75</td><td>90</td><td>20</td><td>13</td><td>35</td><td>10,0</td><td>8,0</td><td>9,20</td><td>0102</td><td>○</td><td>○</td><td>○</td><td>○</td><td>○</td></tr> <tr> <td>M10x1</td><td>1,00</td><td>90</td><td>20</td><td>13</td><td>35</td><td>10,0</td><td>8,0</td><td>9,00</td><td>0103</td><td>●</td><td>●</td><td>●</td><td>●</td><td>●</td></tr> <tr> <td>M10x1,25</td><td>1,25</td><td>100</td><td>20</td><td>15</td><td>39</td><td>10,0</td><td>8,0</td><td>8,80</td><td>0104</td><td>○</td><td>○</td><td>○</td><td>○</td><td>○</td></tr> </tbody> </table>										MF Ød ₁	P	l ₁	l ₂	l ₂ R40	l ₃	Ød ₂	a		Norm					DIN-371															Tol.	ISO2 (6H)	ISO2 (6H)	6HX	6HX	6HX											INDEX	C4-115001	C4-565001	C4-12G901	C4-11G901	C4-50G901	M4x0,5	0,50	63	12	7	21	4,5	3,4	3,50	0041	○	○	○	○	○	M5x0,5	0,50	70	14	8	25	6,0	4,9	4,50	0051	○	○	○	○	○	M6x0,75	0,75	80	14	10	30	6,0	4,9	5,20	0062	○	○	○	○	○	M8x0,75	0,75	80	18	10	30	8,0	6,2	7,20	0082	○	○	○	○	○	M8x1	1,00	90	20	13	35	8,0	6,2	7,00	0083	●	●	●	●	●	M10x0,75	0,75	90	20	13	35	10,0	8,0	9,20	0102	○	○	○	○	○	M10x1	1,00	90	20	13	35	10,0	8,0	9,00	0103	●	●	●	●	●	M10x1,25	1,25	100	20	15	39	10,0	8,0	8,80	0104	○	○	○	○	○						
																			MF Ød ₁	P	l ₁	l ₂	l ₂ R40	l ₃	Ød ₂	a		Norm																																																																																																																																																														
DIN-371																																																																																																																																																																																										
										Tol.	ISO2 (6H)	ISO2 (6H)	6HX	6HX	6HX																																																																																																																																																																											
										INDEX	C4-115001	C4-565001	C4-12G901	C4-11G901	C4-50G901																																																																																																																																																																											
M4x0,5	0,50	63	12	7	21	4,5	3,4	3,50	0041	○	○	○	○	○																																																																																																																																																																												
M5x0,5	0,50	70	14	8	25	6,0	4,9	4,50	0051	○	○	○	○	○																																																																																																																																																																												
M6x0,75	0,75	80	14	10	30	6,0	4,9	5,20	0062	○	○	○	○	○																																																																																																																																																																												
M8x0,75	0,75	80	18	10	30	8,0	6,2	7,20	0082	○	○	○	○	○																																																																																																																																																																												
M8x1	1,00	90	20	13	35	8,0	6,2	7,00	0083	●	●	●	●	●																																																																																																																																																																												
M10x0,75	0,75	90	20	13	35	10,0	8,0	9,20	0102	○	○	○	○	○																																																																																																																																																																												
M10x1	1,00	90	20	13	35	10,0	8,0	9,00	0103	●	●	●	●	●																																																																																																																																																																												
M10x1,25	1,25	100	20	15	39	10,0	8,0	8,80	0104	○	○	○	○	○																																																																																																																																																																												

ISO	Vc (m/min)				
P	5-35	5-35	1-20	1-20	1-20
M	5-15	5-15	1-10	1-10	1-10
K	5-25	5-25	1-20	1-20	1-20
N	10-30	10-30	10-20	10-20	10-20
S	-	-	-	-	-



ISO Metric fine thread DIN-13										<i>FAN-I200</i>		<i>I400-HT</i>					
										B-TS	C-R40-TS	C-TS	B-TS	C-R15-TS			
Material groups																	
Hole type																	
Quality of material										PM/HSSE		PM/HSSE		PM/HSSE			
Coating										TS		TS		TS			
Chamfer										B / 4-5P		C / 2-3P		C / 2-3P			
MF Ød ₁	P	l ₁	l ₂	l ₂ R40	l ₃	Ød ₂	a		Norm		DIN-374						
									Tol.								
									INDEX	ISO2 (6H)	ISO2 (6H)	6HX	6HX	6HX			
M8x1	1,00	90	20	10	-	6,0	4,9	7,00	0083	●	●	●	●	●			
M10x0,75	0,75	90	18	10	-	7,0	5,5	9,20	0102	○	○	○	○	○			
M10x1	1,00	90	20	10	-	7,0	5,5	9,00	0103	●	●	●	●	●			
M10x1,25	1,25	100	20	15	-	7,0	5,5	8,80	0104	○	○	○	○	○			
M12x1	1,00	100	20	10	-	9,0	7,0	11,00	0123	●	●	●	●	●			
M12x1,25	1,25	100	20	15	-	9,0	7,0	10,80	0124	●	●	●	●	●			
M12x1,5	1,50	100	20	15	-	9,0	7,0	10,50	0125	●	●	●	●	●			
M14x1	1,00	100	20	10	-	11,0	9,0	13,00	0143	○	○	○	○	●			
M14x1,25	1,25	100	20	15	-	11,0	9,0	12,80	0144	○	○	○	○	○			
M14x1,5	1,50	100	20	15	-	11,0	9,0	12,50	0145	●	●	●	●	●			
M16x1	1,00	100	20	10	-	12,0	9,0	15,00	0163	●	●	●	●	●			
M16x1,5	1,50	100	20	15	-	12,0	9,0	14,50	0165	●	●	●	●	●			
M18x1	1,00	110	24	13	-	14,0	11,0	17,00	0183	○	○	○	○	○			
M18x1,5	1,50	110	24	17	-	14,0	11,0	16,50	0185	●	●	●	●	●			
M18x2	2,00	125	32	27	-	14,0	11,0	16,00	0186	●	○	○	○	○			
M20x1	1,00	125	24	13	-	16,0	12,0	19,00	0203	○	○	○	○	○			
M20x1,5	1,50	125	24	17	-	16,0	12,0	18,50	0205	●	●	●	●	●			
M20x2	2,00	140	32	27	-	16,0	12,0	18,00	0206	○	○	○	○	○			
M22x1	1,00	125	24	13	-	18,0	14,5	21,00	0223	○	○	○	○	○			
M22x1,5	1,50	125	24	17	-	18,0	14,5	20,50	0225	○	○	○	○	○			
M22x2	2,00	140	32	27	-	18,0	14,5	20,00	0226	○	○	○	○	○			
M24x1	1,00	140	27	13	-	18,0	14,5	23,00	0243	○	○	○	○	○			
M24x1,5	1,50	140	27	20	-	18,0	14,5	22,50	0245	○	○	○	○	○			
M24x2	2,00	140	27	20	-	18,0	14,5	22,00	0246	○	○	○	○	○			
										ISO		Vc (m/min)					
										P	5-35	5-35	1-20	1-20	1-20		
										M	5-15	5-15	1-10	1-10	1-10		
										K	5-25	5-25	1-20	1-20	1-20		
										N	10-30	10-30	10-20	10-20	10-20		
										S	-	-	-	-	-		

1

ISO Metric fine thread DIN-13										INOX																																																																																																																																																																						
										B	B-HL	C-R40	C-R40-HL																																																																																																																																																																			
<div style="display: flex; flex-direction: column; align-items: flex-start;"> <div style="border: 1px solid black; padding: 2px; margin-bottom: 5px;">HSSE</div> <div style="border: 1px solid black; padding: 2px; margin-bottom: 5px;">HL</div> <div style="border: 1px solid black; padding: 2px;">DIN 371</div> </div>										<div style="display: flex; justify-content: space-around;"> <div style="border: 1px solid gray; padding: 2px;">P M K</div> <div style="border: 1px solid gray; padding: 2px;">P M K</div> <div style="border: 1px solid gray; padding: 2px;">P M K</div> <div style="border: 1px solid gray; padding: 2px;">P M K</div> </div>																																																																																																																																																																						
Material groups										<div style="display: flex; justify-content: space-around;"> <div style="border: 1px solid gray; padding: 2px;">N S H</div> <div style="border: 1px solid gray; padding: 2px;">N S H</div> <div style="border: 1px solid gray; padding: 2px;">N S H</div> <div style="border: 1px solid gray; padding: 2px;">N S H</div> </div>																																																																																																																																																																						
Hole type										<div style="display: flex; justify-content: space-around;"> <div style="border: 1px solid gray; padding: 2px; text-align: center;">< 3d</div> <div style="border: 1px solid gray; padding: 2px; text-align: center;">< 3d</div> <div style="border: 1px solid gray; padding: 2px; text-align: center;">< 2.5d</div> <div style="border: 1px solid gray; padding: 2px; text-align: center;">< 2.5d</div> </div>																																																																																																																																																																						
Quality of material										HSSE																																																																																																																																																																						
Coating										HL																																																																																																																																																																						
Chamfer										B / 4-5P B / 4-5P C / 2-3P C / 2-3P																																																																																																																																																																						
<table border="1" style="width: 100%; border-collapse: collapse;"> <thead> <tr> <th rowspan="3">MF ød₁</th> <th rowspan="3">P</th> <th rowspan="3">l₁</th> <th rowspan="3">l₂</th> <th rowspan="3">l₂ R40</th> <th rowspan="3">l₃</th> <th rowspan="3">ød₂</th> <th rowspan="3">a</th> <th rowspan="3"></th> <th colspan="5">Norm</th> </tr> <tr> <th colspan="5">DIN-371</th> </tr> <tr> <th>Tol.</th> <th>ISO2 (6H)</th> <th>ISO2 (6H)</th> <th>ISO2 (6H)</th> <th>ISO2 (6H)</th> </tr> </thead> <tbody> <tr> <td>M4x0,5</td><td>0,50</td><td>63</td><td>12</td><td>7</td><td>21</td><td>4,5</td><td>3,4</td><td>3,50</td><td>0041</td><td>●</td><td>●</td><td>●</td><td>●</td><td></td><td></td><td></td> </tr> <tr> <td>M5x0,5</td><td>0,50</td><td>70</td><td>14</td><td>8</td><td>25</td><td>6,0</td><td>4,9</td><td>4,50</td><td>0051</td><td>●</td><td>●</td><td>●</td><td>●</td><td></td><td></td><td></td> </tr> <tr> <td>M6x0,75</td><td>0,75</td><td>80</td><td>14</td><td>10</td><td>30</td><td>6,0</td><td>4,9</td><td>5,20</td><td>0062</td><td>●</td><td>●</td><td>●</td><td>●</td><td></td><td></td><td></td> </tr> <tr> <td>M8x0,75</td><td>0,75</td><td>80</td><td>18</td><td>10</td><td>30</td><td>8,0</td><td>6,2</td><td>7,20</td><td>0082</td><td>●</td><td>●</td><td>●</td><td>●</td><td></td><td></td><td></td> </tr> <tr> <td>M8x1</td><td>1,00</td><td>90</td><td>20</td><td>13</td><td>35</td><td>8,0</td><td>6,2</td><td>7,00</td><td>0083</td><td>●</td><td>●</td><td>●</td><td>●</td><td></td><td></td><td></td> </tr> <tr> <td>M10x0,75</td><td>0,75</td><td>90</td><td>20</td><td>13</td><td>35</td><td>10,0</td><td>8,0</td><td>9,20</td><td>0102</td><td>●</td><td>●</td><td>●</td><td>●</td><td></td><td></td><td></td> </tr> <tr> <td>M10x1</td><td>1,00</td><td>90</td><td>20</td><td>13</td><td>35</td><td>10,0</td><td>8,0</td><td>9,00</td><td>0103</td><td>●</td><td>●</td><td>●</td><td>●</td><td></td><td></td><td></td> </tr> <tr> <td>M10x1,25</td><td>1,25</td><td>100</td><td>20</td><td>15</td><td>39</td><td>10,0</td><td>8,0</td><td>8,80</td><td>0104</td><td>●</td><td>●</td><td>●</td><td>●</td><td></td><td></td><td></td> </tr> </tbody> </table>										MF ød ₁	P	l ₁	l ₂	l ₂ R40	l ₃	ød ₂	a		Norm					DIN-371					Tol.	ISO2 (6H)	ISO2 (6H)	ISO2 (6H)	ISO2 (6H)	M4x0,5	0,50	63	12	7	21	4,5	3,4	3,50	0041	●	●	●	●				M5x0,5	0,50	70	14	8	25	6,0	4,9	4,50	0051	●	●	●	●				M6x0,75	0,75	80	14	10	30	6,0	4,9	5,20	0062	●	●	●	●				M8x0,75	0,75	80	18	10	30	8,0	6,2	7,20	0082	●	●	●	●				M8x1	1,00	90	20	13	35	8,0	6,2	7,00	0083	●	●	●	●				M10x0,75	0,75	90	20	13	35	10,0	8,0	9,20	0102	●	●	●	●				M10x1	1,00	90	20	13	35	10,0	8,0	9,00	0103	●	●	●	●				M10x1,25	1,25	100	20	15	39	10,0	8,0	8,80	0104	●	●	●	●										
																			MF ød ₁	P	l ₁	l ₂	l ₂ R40	l ₃	ød ₂	a		Norm																																																																																																																																																				
DIN-371																																																																																																																																																																																
Tol.	ISO2 (6H)	ISO2 (6H)	ISO2 (6H)	ISO2 (6H)																																																																																																																																																																												
M4x0,5	0,50	63	12	7	21	4,5	3,4	3,50	0041	●	●	●	●																																																																																																																																																																			
M5x0,5	0,50	70	14	8	25	6,0	4,9	4,50	0051	●	●	●	●																																																																																																																																																																			
M6x0,75	0,75	80	14	10	30	6,0	4,9	5,20	0062	●	●	●	●																																																																																																																																																																			
M8x0,75	0,75	80	18	10	30	8,0	6,2	7,20	0082	●	●	●	●																																																																																																																																																																			
M8x1	1,00	90	20	13	35	8,0	6,2	7,00	0083	●	●	●	●																																																																																																																																																																			
M10x0,75	0,75	90	20	13	35	10,0	8,0	9,20	0102	●	●	●	●																																																																																																																																																																			
M10x1	1,00	90	20	13	35	10,0	8,0	9,00	0103	●	●	●	●																																																																																																																																																																			
M10x1,25	1,25	100	20	15	39	10,0	8,0	8,80	0104	●	●	●	●																																																																																																																																																																			
										<table border="1" style="width: 100%; border-collapse: collapse;"> <thead> <tr> <th>ISO</th> <th colspan="4">Vc (m/min)</th> </tr> </thead> <tbody> <tr> <td>P</td> <td>-</td><td>-</td><td>-</td><td>-</td> </tr> <tr> <td>M</td> <td>5-15</td><td>5-15</td><td>5-15</td><td>5-15</td> </tr> <tr> <td>K</td> <td>-</td><td>-</td><td>-</td><td>-</td> </tr> <tr> <td>N</td> <td>-</td><td>-</td><td>-</td><td>-</td> </tr> <tr> <td>S</td> <td>-</td><td>-</td><td>-</td><td>-</td> </tr> </tbody> </table>				ISO	Vc (m/min)				P	-	-	-	-	M	5-15	5-15	5-15	5-15	K	-	-	-	-	N	-	-	-	-	S	-	-	-	-																																																																																																																																					
ISO	Vc (m/min)																																																																																																																																																																															
P	-	-	-	-																																																																																																																																																																												
M	5-15	5-15	5-15	5-15																																																																																																																																																																												
K	-	-	-	-																																																																																																																																																																												
N	-	-	-	-																																																																																																																																																																												
S	-	-	-	-																																																																																																																																																																												



ISO Metric fine thread DIN-13										INOX									
										B	B-HL	C-R40	C-R40-HL						
<div style="display: flex; flex-direction: column; align-items: center;"> <div style="border: 1px solid black; padding: 2px; margin-bottom: 5px;">HSSE</div> <div style="border: 1px solid black; padding: 2px; margin-bottom: 5px;">HL</div> <div style="border: 1px solid black; padding: 2px;">DIN 374</div> </div>										<div style="display: flex; justify-content: space-around;"> <div style="border: 1px solid gray; padding: 2px;">P M K N S H</div> <div style="border: 1px solid gray; padding: 2px;">P M K N S H</div> <div style="border: 1px solid gray; padding: 2px;">P M K N S H</div> <div style="border: 1px solid gray; padding: 2px;">P M K N S H</div> </div>									
Material groups																			
Hole type										<div style="display: flex; justify-content: space-around;"> <div style="text-align: center;"> < 3d</div> <div style="text-align: center;"> < 3d</div> <div style="text-align: center;"> < 2.5d</div> <div style="text-align: center;"> < 2.5d</div> </div>									
Quality of material										HSSE									
Coating										HL									
Chamfer										B / 4-5P B / 4-5P C / 2-3P C / 2-3P									
MF Ød ₁	P	l ₁	l ₂	l ₂ R40	l ₃	Ød ₂	a		Norm		DIN-374								
									Tol.	INDEX	ISO2 (6H)	ISO2 (6H)	ISO2 (6H)	ISO2 (6H)					
											D2-111801	D2-118801	D2-511801	D2-518801					
M8x1	1,00	90	20	10	-	6,0	4,9	7,00	0083	●	○	●	○						
M10x0,75	0,75	90	18	10	-	7,0	5,5	9,20	0102	●	○	●	○						
M10x1	1,00	90	20	10	-	7,0	5,5	9,00	0103	●	●	●	●						
M10x1,25	1,25	100	20	15	-	7,0	5,5	8,80	0104	●	○	●	○						
M12x1	1,00	100	20	10	-	9,0	7,0	11,00	0123	●	○	●	○						
M12x1,25	1,25	100	20	15	-	9,0	7,0	10,80	0124	●	○	●	○						
M12x1,5	1,50	100	20	15	-	9,0	7,0	10,50	0125	●	●	●	●						
M14x1	1,00	100	20	10	-	11,0	9,0	13,00	0143	○	○	○	○						
M14x1,25	1,25	100	20	15	-	11,0	9,0	12,80	0144	○	○	○	○						
M14x1,5	1,50	100	20	15	-	11,0	9,0	12,50	0145	●	○	●	○						
M15x1	1,00	100	20	10	-	12,0	9,0	14,00	0153	○	○	○	○						
M16x1	1,00	100	20	10	-	12,0	9,0	15,00	0163	●	○	●	○						
M16x1,5	1,50	100	20	15	-	12,0	9,0	14,50	0165	●	●	●	●						
M18x1	1,00	110	24	13	-	14,0	11,0	17,00	0183	○	○	○	○						
M18x1,5	1,50	110	24	17	-	14,0	11,0	16,50	0185	●	○	●	○						
M18x2	2,00	125	27	20	-	14,0	11,0	16,00	0186	○	○	○	○						
M20x1	1,00	125	24	13	-	16,0	12,0	19,00	0203	○	○	○	○						
M20x1,5	1,50	125	24	17	-	16,0	12,0	18,50	0205	●	●	●	●						
M20x2	2,00	140	27	20	-	16,0	12,0	18,00	0206	○	○	○	○						
M22x1	1,00	125	24	13	-	18,0	14,5	21,00	0223	○	○	○	○						
M22x1,5	1,50	125	24	17	-	18,0	14,5	20,50	0225	●	○	●	○						
M22x2	2,00	140	27	20	-	18,0	14,5	20,00	0226	○	○	○	○						
M24x1	1,00	140	27	13	-	18,0	14,5	23,00	0243	○	○	○	○						
M24x1,5	1,50	140	27	20	-	18,0	14,5	22,50	0245	○	○	○	○						
M24x2	2,00	140	27	20	-	18,0	14,5	22,00	0246	○	○	○	○						
M26x1,5	1,50	140	27	20	-	18,0	14,5	24,50	0265	○	○	○	○						
M27x1,5	1,50	140	27	20	-	20,0	16,0	25,50	0275	○	○	○	○						
M27x2	2,00	140	27	20	-	20,0	16,0	25,00	0276	○	○	○	○						
M28x1,5	1,50	140	27	20	-	20,0	16,0	26,50	0285	○	○	○	○						
										ISO		Vc (m/min)							
										P		-							
										M		5-15							
										K		-							
										N		-							
										S		-							

● Available from stock
○ On request

1

ISO Metric fine thread DIN-13										INOX																																	
										B	B-HL	C-R40	C-R40-HL																														
<div style="display: flex; flex-direction: column; align-items: flex-start;"> <div style="border: 1px solid black; padding: 2px; margin-bottom: 5px;">HSSE</div> <div style="border: 1px solid black; padding: 2px; margin-bottom: 5px;">HL</div> <div style="border: 1px solid black; padding: 2px;">DIN 374</div> </div>										<table border="1"> <tr><td>P</td><td>M</td><td>K</td></tr> <tr><td>N</td><td>S</td><td>H</td></tr> </table>		P	M	K	N	S	H	<table border="1"> <tr><td>P</td><td>M</td><td>K</td></tr> <tr><td>N</td><td>S</td><td>H</td></tr> </table>		P	M	K	N	S	H	<table border="1"> <tr><td>P</td><td>M</td><td>K</td></tr> <tr><td>N</td><td>S</td><td>H</td></tr> </table>		P	M	K	N	S	H	<table border="1"> <tr><td>P</td><td>M</td><td>K</td></tr> <tr><td>N</td><td>S</td><td>H</td></tr> </table>		P	M	K	N	S	H		
P	M	K																																									
N	S	H																																									
P	M	K																																									
N	S	H																																									
P	M	K																																									
N	S	H																																									
P	M	K																																									
N	S	H																																									
Material groups										<table border="1"> <tr><td>P</td><td>M</td><td>K</td></tr> <tr><td>N</td><td>S</td><td>H</td></tr> </table>		P	M	K	N	S	H	<table border="1"> <tr><td>P</td><td>M</td><td>K</td></tr> <tr><td>N</td><td>S</td><td>H</td></tr> </table>		P	M	K	N	S	H	<table border="1"> <tr><td>P</td><td>M</td><td>K</td></tr> <tr><td>N</td><td>S</td><td>H</td></tr> </table>		P	M	K	N	S	H										
P	M	K																																									
N	S	H																																									
P	M	K																																									
N	S	H																																									
P	M	K																																									
N	S	H																																									
Hole type																																											
Quality of material										HSSE		HSSE		HSSE		HSSE																											
Coating												HL				HL																											
Chamfer										B / 4-5P		B / 4-5P		C / 2-3P		C / 2-3P																											
MF Ød ₁	P	l ₁	l ₂	l ₂ R40	l ₃	Ød ₂	a		Norm																																		
									DIN-374																																		
									Tol.	ISO2 (6H)	ISO2 (6H)	ISO2 (6H)	ISO2 (6H)																														
										INDEX	D2-111801	D2-118801	D2-511801	D2-518801																													
M28x2	2,0	140	27	20	-	20,0	16,0	26,00	0286	o	o	o	o																														
M30x1,5	1,5	150	27	22	-	22,0	18,0	28,50	0305	o	o	o	o																														
M30x2	2,0	150	27	22	-	22,0	18,0	28,00	0306	o	o	o	o																														
M32x1,5	1,5	150	27	22	-	22,0	18,0	30,50	0325	o	o	o	o																														
M32x2	2,0	150	27	22	-	22,0	18,0	30,00	0326	o	o	o	o																														
M33x1,5	1,5	160	30	22	-	25,0	20,0	31,50	0335	o	o	o	o																														
M33x2	2,0	160	30	24	-	25,0	20,0	31,00	0336	o	o	o	o																														
M34x1,5	1,5	170	30	22	-	28,0	22,0	32,50	0345	o	o	o	o																														
M35x1,5	1,5	170	30	22	-	28,0	22,0	33,50	0355	o	o	o	o																														
M36x1,5	1,5	170	30	22	-	28,0	22,0	34,50	0365	o	o	o	o																														
M36x2	2,0	170	30	24	-	28,0	22,0	34,00	0366	o	o	o	o																														
M36x3	3,0	200	50	30	-	28,0	22,0	33,00	0367	o	o	o	o																														
										ISO					Vc (m/min)																												
										P	-	-	-	-																													
										M	5-15	5-15	5-15	5-15																													
										K	-	-	-	-																													
										N	-	-	-	-																													
										S	-	-	-	-																													



ISO Metric fine thread DIN-13									GG					GAL		
									C-TS	C-IK-TS	E-TS	E-IK-TS	E-IKR-TS	C-R15-TS	E-R15-IK-TS	
Material groups									P M K	P M K	P M K	P M K	P M K	P M K	P M K	
Hole type																
Quality of material									HSSE-PM	HSSE-PM	HSSE-PM	HSSE-PM	HSSE-PM	HSSE-PM		
Coating									TS	TS	TS	TS	TS	TS		
Chamfer									C / 2-3P	C / 2-3P	E / 1,5-2P	E / 1,5-2P	E / 1,5-2P	C / 2-3P	E / 1,5-2P	
MF ød ₁	P	l ₁	l ₂	l ₃	ød ₂	a		Norm								
								DIN-371								
								Tol.	6HX	6HX	6HX	6HX	6HX	6HX	6HX	6HX
								INDEX	C2-125501	C4-125551	C2-145501	C4-145551	C4-145561	C2-505601	C4-655601	
M8x1	1,00	90	20	35	8,0	6,2	7,00	0083	●	○	●	○	○	●	○	
M10x0,75	0,75	90	20	35	10,0	8,0	9,20	0102	○	○	○	○	○	○	○	
M10x1	1,00	90	20	35	10,0	8,0	9,00	0103	●	○	●	○	○	●	○	
M10x1,25	1,25	100	20	39	10,0	8,0	8,80	0104	○	○	●	○	○	●	○	
ISO									Vc (m/min)							
P									-	-	-	-	-	-	-	-
M									-	-	-	-	-	-	-	-
K									1-60	1-60	1-60	1-60	1-60	-	-	
N									-	-	-	-	-	10-30	10-30	
S									-	-	-	-	-	-	-	

1

ISO Metric fine thread DIN-13								GG					GAL								
								C-TS	C-IK-TS	E-TS	E-IK-TS	E-IKR-TS	C-R15-TS	E-R15-IK-TS							
 HSSE PM TS DIN 374																					
Material groups								P M K	P M K	P M K	P M K	P M K	P M K	P M K	P M K	P M K	P M K				
Hole type																					
Quality of material								HSSE-PM	HSSE-PM	HSSE-PM	HSSE-PM	HSSE-PM	HSSE-PM	HSSE-PM	HSSE-PM	HSSE-PM					
Coating								TS	TS	TS	TS	TS	TS	TS	TS	TS	TS				
Chamfer								C / 2-3P	C / 2-3P	E / 1,5-2P	E / 1,5-2P	E / 1,5-2P	C / 2-3P	E / 1,5-2P	E / 1,5-2P						
MF ød ₁	P	l ₁	l ₂	ød ₂	a		Norm														
							DIN-374														
							Tol.	6HX	6HX	6HX	6HX	6HX	6HX	6HX	6HX						
							INDEX	D2-125501	D4-125551	D2-145501	D4-145551	D4-145561	D2-505601	D4-655651							
M8x1	1,00	90	20	6,0	4,9	7,00	0083	●	○	●	○	○	●	○							
M10x0,75	0,75	90	18	7,0	5,5	9,2	0102	○	○	○	○	○	○	○							
M10x1	1,00	90	20	7,0	5,5	9,00	0103	●	●	●	○	○	●	●							
M10x1,25	1,25	100	20	7,0	5,5	8,80	0104	○	○	○	○	○	○	○							
M12x1	1,00	100	20	9,0	7,0	11,00	0123	○	○	○	○	○	○	○							
M12x1,25	1,25	100	20	9,0	7,0	10,80	0124	○	○	○	○	○	○	○							
M12x1,5	1,50	100	20	9,0	7,0	10,50	0125	●	●	●	○	○	●	●							
M14x1	1,00	100	20	11,0	9,0	13,00	0143	○	○	○	○	○	○	○							
M14x1,25	1,25	100	20	11,0	9,0	12,80	0144	○	○	○	○	○	○	○							
M14x1,5	1,50	100	20	11,0	9,0	12,50	0145	●	●	●	○	○	●	●							
M16x1	1,00	100	20	12,0	9,0	15,00	0163	○	○	○	○	○	○	○							
M16x1,5	1,50	100	20	12,0	9,0	14,50	0165	●	●	●	○	○	●	●							
M18x1	1,00	110	24	14,0	11,0	17,00	0183	○	○	○	○	○	○	○							
M18x1,5	1,50	110	24	14,0	11,0	16,50	0185	●	○	●	○	○	○	○							
M18x2	2,00	125	27	14,0	11,0	16,00	0186	○	○	○	○	○	○	○							
M20x1	1,00	125	24	16,0	12,0	19,00	0203	○	○	○	○	○	○	○							
M20x1,5	1,50	125	24	16,0	12,0	18,50	0205	●	○	○	○	○	○	○							
M20x2	2,00	140	27	16,0	12,0	18,00	0206	○	○	○	○	○	○	○							
								Vc (m/min)													
ISO																					
P								-	-	-	-	-	-	-	-						
M								-	-	-	-	-	-	-	-						
K								1-60	1-60	1-60	1-60	1-60	-	-							
N								-	-	-	-	-	10-30	10-30							
S								-	-	-	-	-	-	-							

ISO Metric fine thread DIN-13										S-NC						
										B-TC	C-R45-TC	C-R45-IK-TC				
<div style="display: flex; flex-direction: column; gap: 5px;"> <div style="border: 1px solid black; padding: 2px; background-color: #f0f0f0;">HSSE PM</div> <div style="border: 1px solid black; padding: 2px; background-color: #4a7ebb; color: white;">TC</div> <div style="border: 1px solid black; padding: 2px; background-color: #f0f0f0;">DIN 371</div> </div>										<div style="display: flex; justify-content: space-around;"> <div style="display: flex; flex-wrap: wrap; gap: 2px;"> P M K </div> <div style="display: flex; flex-wrap: wrap; gap: 2px;"> N S H </div> </div>						
Material groups										<div style="display: flex; justify-content: space-around;"> <div style="display: flex; flex-wrap: wrap; gap: 2px;"> P M K </div> <div style="display: flex; flex-wrap: wrap; gap: 2px;"> N S H </div> </div>						
Hole type										<div style="display: flex; justify-content: space-around;"> <div style="text-align: center;"> < 3d</div> <div style="text-align: center;"> < 2,5d</div> <div style="text-align: center;"> < 2,5d</div> </div>						
Quality of material										HSSE-PM						
Coating										TC						
Chamfer										B / 4-5P C / 2-3P C / 2-3P						
MF Ød ₁	P	l ₁	l ₂	l ₃	Ød ₂	a		Norm								
								DIN-371								
								Tol.	6HX	6HX					6HX	
INDEX	C4-115301	C4-525301	C4-525351													
M4x0,5	0,50	63	7	21	4,5	3,4	3,50	0041	○	○	○					
M5x0,5	0,50	70	8	25	6,0	4,9	4,50	0051	○	○	○					
M6x0,75	0,75	80	10	30	6,0	4,9	5,20	0062	○	○	○					
M8x0,75	0,75	80	10	30	8,0	6,2	7,20	0082	●	●	○					
M8x1	1,00	90	13	35	8,0	6,2	7,00	0083	○	○	○					
M10x0,75	0,75	90	13	35	10,0	8,0	9,20	0102	○	○	○					
M10x1	1,00	90	13	35	10,0	8,0	9,00	0103	●	●	○					
M10x1,25	1,25	100	15	39	10,0	8,0	8,80	0104	○	○	○					
ISO										V _c (m/min)						
P										5-50	5-50	5-60				
M										5-20	5-20	5-30				
K										5-40	5-40	5-60				
N										5-40	5-40	5-60				
S										1-8	1-8	1-8				

1

ISO Metric fine thread DIN-13									S-NC							
									B-TC	C-R45-TC	C-R45-IK-TC					
<div style="display: flex; flex-direction: column; align-items: center;"> <div style="border: 1px solid black; padding: 2px; margin-bottom: 5px;">HSSE PM</div> <div style="border: 1px solid black; padding: 2px; margin-bottom: 5px;">TC</div> <div style="border: 1px solid black; padding: 2px; margin-bottom: 5px;">DIN 374</div> </div>																
Material groups									P M K	P M K	P M K					
Hole type																
Quality of material									PM/HSSE	PM/HSSE	PM/HSSE					
Coating									TC	TC	TC					
Chamfer									B / 4-5P	C / 2-3P	C / 2-3P					
MF Ød ₁	P	l ₁	l ₂	l ₃	Ød ₂	a		Norm								
								DIN-374								
								Tol.	6HX	6HX					6HX	
									INDEX	D4-115301	D4-525301	D4-525351				
M8x1	1,00	90	10	-	6,0	4,9	7,00	0083	○	○	○					
M10x1	1,00	90	10	-	7,0	5,5	9,00	0103	○	○	○					
M10x1,25	1,25	100	15	-	7,0	5,5	8,80	0104	○	○	○					
M11x1	1,00	90	10	-	8,0	6,2	10,00	0113	○	○	○					
M12x1	1,00	100	10	-	9,0	7,0	11,00	0123	○	○	○					
M12x1,25	1,25	100	15	-	9,0	7,0	10,80	0124	○	○	○					
M12x1,5	1,50	100	15	-	9,0	7,0	10,50	0125	●	●	○					
M14x1	1,00	100	10	-	11,0	9,0	13,00	0143	○	○	○					
M14x1,25	1,25	100	15	-	11,0	9,0	12,80	0144	○	○	○					
M14x1,5	1,50	100	15	-	11,0	9,0	12,50	0145	●	●	○					
M15x1	1,00	100	10	-	12,0	9,0	14,00	0153	○	○	○					
M16x1	1,00	100	10	-	12,0	9,0	15,00	0163	○	○	○					
M16x1,5	1,50	100	15	-	12,0	9,0	14,50	0165	●	●	○					
ISO									V _c (m/min)							
P									5-50	5-50	5-60					
M									5-20	5-20	5-30					
K									5-40	5-40	5-60					
N									5-40	5-40	5-60					
S									1-8	1-8	1-8					



ISO Metric fine thread DIN-13															
HSS DIN 2181															
Material groups															
<table border="1"> <tr> <td>P</td> <td>M</td> <td>K</td> </tr> <tr> <td>N</td> <td>S</td> <td>H</td> </tr> </table>										P	M	K	N	S	H
P	M	K													
N	S	H													
Hole type															
Quality of material															
HSS															
Coating															
Chamfer															
~3P															
MF $\varnothing d_1$	P	l_1	l_2	l_3	$\varnothing d_2$	a		Norm							
								DIN-2181							
								ISO2 (6H)							
								INDEX							
								E1-131001							
M4x0,5	0,50	45	10	18,0	4,5	3,4	3,5	0041	○						
M4,5x0,5	0,50	50	12	22,0	6,0	4,9	4,0	0046	○						
M5x0,5	0,50	52	13	22,0	6,0	4,9	4,5	0051	○						
M5,5x0,5	0,50	56	13	24,0	6,0	4,9	5,0	0056	○						
M6x0,75	0,75	56	14	24,0	6,0	4,9	5,2	0062	●						
M7x0,75	0,75	56	14	-	6,0	4,9	6,2	0072	○						
M8x0,75	0,75	63	14	-	6,0	4,9	7,2	0082	●						
M8x1	1,00	63	17	-	6,0	4,9	7,0	0083	●						
M9x0,75	0,75	63	14	-	7,0	5,5	8,2	0092	○						
M9x1	1,00	63	17	-	7,0	5,5	8,0	0093	○						
M10x0,75	0,75	63	18	-	7,0	5,5	9,2	0102	○						
M10x1	1,00	63	18	-	7,0	5,5	9,0	0103	●						
M10x1,25	1,25	70	22	-	7,0	5,5	8,8	0104	●						
M11x0,75	0,75	63	18	-	8,0	6,2	10,2	0112	○						
M11x1	1,00	63	18	-	8,0	6,2	10,0	0113	○						
M12x1	1,00	70	18	-	9,0	7,0	11,0	0123	●						
M12x1,25	1,25	70	20	-	9,0	7,0	10,8	0124	●						
M12x1,5	1,50	70	20	-	9,0	7,0	10,5	0125	●						
M14x1	1,00	70	18	-	11,0	9,0	13,0	0143	○						
M14x1,25	1,25	70	20	-	11,0	9,0	12,8	0144	●						
M14x1,5	1,50	70	20	-	11,0	9,0	12,5	0145	●						
M15x1	1,00	70	18	-	12,0	9,0	14,0	0153	○						
M15x1,5	1,50	70	20	-	12,0	9,0	13,5	0155	○						
M16x1	1,00	80	18	-	12,0	9,0	15,0	0163	○						
M16x1,25	1,25	80	18	-	18,0	9,0	14,8	0164	○						
M16x1,5	1,50	80	22	-	12,0	9,0	14,5	0165	●						
M17x1	1,00	80	18	-	12,0	9,0	16,0	0173	○						
M17x1,5	1,50	80	22	-	12,0	9,0	15,5	0175	○						
M18x1	1,00	80	18	-	14,0	11,0	17,0	0183	○						
M18x1,5	1,50	80	22	-	14,0	11,0	16,5	0185	●						
M18x2	2,00	80	22	-	14,0	11,0	16,0	0186	○						
M20x1	1,00	80	18	-	16,0	12,0	19,0	0203	○						

● Available from stock
 ○ On request

ISO	Vc (m/min)				
P	5-20				
M	-				
K	-				
N	-				
S	-				

1

ISO Metric fine thread DIN-13

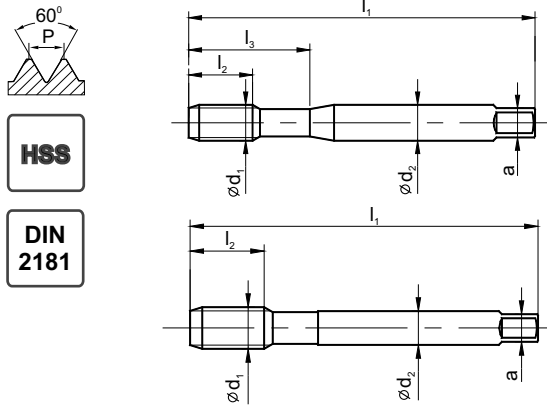

Material groups



Hole type



Quality of material

HSS

Coating

Chamfer

~3P

MF Ød ₁	P	l ₁	l ₂	l ₃	Ød ₂	a		Norm	
								DIN-2181	
								Tol.	ISO2 (6H)
INDEX									E1-131001
M20x1,5	1,50	80	22	-	16	12,0	18,5	0205	●
M20x2	2,00	80	22	-	16	12,0	18,0	0206	○
M22x1	1,00	80	18	-	18	14,5	21,0	0223	○
M22x1,5	1,5	80	22	-	18	14,5	20,5	0225	●
M22x2	2,0	80	22	-	18	14,5	20,0	0226	○
M24x1	1,0	90	18	-	18	14,5	23,0	0243	○
M24x1,5	1,5	90	22	-	18	14,5	22,5	0245	●
M24x2	2,0	90	22	-	18	14,5	22,0	0246	●
M25x1	1,0	90	18	-	18	14,5	24,0	0253	○
M25x1,5	1,5	90	22	-	18	14,5	23,5	0255	●
M25x2	2,0	90	22	-	18	14,5	23,0	0256	○
M26x1,5	1,5	90	22	-	18	14,5	24,5	0265	●
M27x1	1,0	90	20	-	20	16,0	26,0	0273	○
M27x1,5	1,5	90	22	-	20	16,0	25,5	0275	○
M27x2	2,0	90	22	-	20	16,0	25,0	0276	○
M28x1	1,0	90	20	-	20	16,0	27,0	0283	○
M28x1,5	1,5	90	22	-	20	16,0	26,5	0285	○
M28x2	2,0	90	22	-	20	16,0	26,0	0286	○
M30x1	1,0	90	22	-	22	18,0	29,0	0303	○
M30x1,5	1,5	90	22	-	22	18,0	28,5	0305	●
M30x2	2,0	90	22	-	22	18,0	28,0	0306	○
M30x3	3,0	125	36	-	22	18,0	27,0	0307	○
M32x1,5	1,5	90	22	-	22	18,0	30,5	0325	○
M32x2	2,0	90	22	-	22	18,0	30,0	0326	○
M33x1,5	1,5	100	25	-	25	20,0	31,5	0335	○
M33x2	2,0	100	25	-	25	20,0	31,0	0336	○
M33x3	3,0	125	36	-	25	20,0	30,0	0337	○
M35x1,5	1,5	100	25	-	28	22,0	33,5	0355	○
M36x1,5	1,5	100	25	-	28	22,0	34,5	0365	○
M36x2	2,0	125	36	-	28	22,0	34,0	0366	○
M36x3	3,0	125	36	-	28	22,0	33,0	0367	○
M38x1,5	1,5	100	25	-	28	22,0	36,5	0385	○

- Available from stock
- On request

ISO	Vc (m/min)			
P	5-20			
M	-			
K	-			
N	-			
S	-			



ISO Metric fine thread DIN-13																																																																
HSS DIN 2181																																																																
Material groups										<table border="1"> <tr><td>P</td><td>M</td><td>K</td></tr> <tr><td>N</td><td>S</td><td>H</td></tr> </table>	P	M	K	N	S	H																																																
P	M	K																																																														
N	S	H																																																														
Hole type																																																																
Quality of material										HSS																																																						
Coating																																																																
Chamfer										~3P																																																						
MF $\varnothing d_1$	P	l_1	l_2	l_3	$\varnothing d_2$	a		Norm																																																								
								DIN-2181																																																								
								ISO2 (6H)																																																								
								INDEX	E1-131001																																																							
M39x1,5	1,5	110	25	-	32	24	37,5	0395	o																																																							
M39x2	2,0	125	36	-	32	24	37,0	0396	o																																																							
M39x3	3,0	125	36	-	32	24	36,0	0397	o																																																							
M40x1,5	1,5	110	25	-	32	24	38,5	0405	o																																																							
M40x2	2,0	125	36	-	32	24	38,0	0406	o																																																							
M40x3	3,0	125	36	-	32	24	37,0	0407	o																																																							
M42x1,5	1,5	110	25	-	32	24	40,5	0425	o																																																							
M42x2	2,0	125	36	-	32	24	40,0	0426	o																																																							
M42x3	3,0	125	36	-	32	24	39,0	0427	o																																																							
M42x4	4,0	150	50	-	32	24	38,0	0428	o																																																							
M45x1,5	1,5	110	25	-	36	29	43,5	0455	o																																																							
M45x2	2,0	125	36	-	36	29	43,0	0456	o																																																							
M45x3	3,0	125	36	-	36	29	42,0	0457	o																																																							
M45x4	4,0	160	50	-	36	29	41,0	0458	o																																																							
M48x1,5	1,5	140	30	-	36	29	46,5	0485	o																																																							
M48x2	2,0	140	36	-	36	29	46,0	0486	o																																																							
M48x3	3,0	140	36	-	36	29	45,0	0487	o																																																							
M48x4	4,0	180	55	-	36	29	44,0	0488	o																																																							
M50x1,5	1,5	140	30	-	36	29	48,5	0505	o																																																							
M50x2	2,0	140	36	-	36	29	48,0	0506	o																																																							
M50x3	3,0	140	36	-	36	29	47,0	0507	o																																																							
M52x1,5	1,5	140	30	-	40	32	50,5	0525	o																																																							
M52x2	2,0	140	36	-	40	32	50,0	0526	o																																																							
M52x3	3,0	140	40	-	40	32	49,0	0527	o																																																							
M52x4	4,0	180	55	-	40	32	48,0	0528	o																																																							
										<table border="1"> <thead> <tr> <th>ISO</th> <th colspan="7">Vc (m/min)</th> </tr> </thead> <tbody> <tr> <td>P</td> <td>5-20</td> <td></td> <td></td> <td></td> <td></td> <td></td> <td></td> </tr> <tr> <td>M</td> <td>-</td> <td></td> <td></td> <td></td> <td></td> <td></td> <td></td> </tr> <tr> <td>K</td> <td>-</td> <td></td> <td></td> <td></td> <td></td> <td></td> <td></td> </tr> <tr> <td>N</td> <td>-</td> <td></td> <td></td> <td></td> <td></td> <td></td> <td></td> </tr> <tr> <td>S</td> <td>-</td> <td></td> <td></td> <td></td> <td></td> <td></td> <td></td> </tr> </tbody> </table>							ISO	Vc (m/min)							P	5-20							M	-							K	-							N	-							S	-						
ISO	Vc (m/min)																																																															
P	5-20																																																															
M	-																																																															
K	-																																																															
N	-																																																															
S	-																																																															

1

ISO Metric fine thread DIN-13				NUTAP					
				soldered	torsioned				
 <div style="border: 1px solid black; padding: 2px; display: inline-block;">HSSE</div> <div style="border: 1px solid black; padding: 2px; display: inline-block; background-color: #8B4513; color: white;">TS</div>									
Material groups				<div style="display: flex; gap: 5px;"> <div style="border: 1px solid black; padding: 1px;">P</div> <div style="border: 1px solid black; padding: 1px;">M</div> <div style="border: 1px solid black; padding: 1px;">K</div> </div> <div style="display: flex; gap: 5px;"> <div style="border: 1px solid black; padding: 1px;">N</div> <div style="border: 1px solid black; padding: 1px;">S</div> <div style="border: 1px solid black; padding: 1px;">H</div> </div>	<div style="display: flex; gap: 5px;"> <div style="border: 1px solid black; padding: 1px;">P</div> <div style="border: 1px solid black; padding: 1px;">M</div> <div style="border: 1px solid black; padding: 1px;">K</div> </div> <div style="display: flex; gap: 5px;"> <div style="border: 1px solid black; padding: 1px;">N</div> <div style="border: 1px solid black; padding: 1px;">S</div> <div style="border: 1px solid black; padding: 1px;">H</div> </div>				
Hole type									
Quality of material				HSSE	HSSE				
Coating				TS	TS				
Chamfer				12P	12P				
M	P	Overall dimensions		On request					
M8x1	1,0	On request	7,0						
M10x1	1,0		9,0						
M12x1	1,0		11,0						
M12x1,5	1,5		10,5						
M14x1,5	1,5		12,5						
M16x1	1,0		15,0						
M16x1,5	1,5		14,5						
M18x1,5	1,5		16,5						
M20x1,5	1,5		18,5						
M20x2	2,0		18,0						
M22x1,5	1,5		20,5						
M22x2	2,0		20,0						
M24x1,5	1,5		22,5						
M24x2	2,0		22,0						
M27x1,5	1,5		25,5						
M27x2	2,0		25,0						
ISO				Vc (m/min)					
P				5-20	5-20				
M				-	-				
K				-	-				
N				-	-				
S				-	-				



ISO Metric fine thread DIN-13								NGMf									
 								LH									
Material groups																	
Hole type																	
Quality of material								HSS	HSS								
Coating																	
Chamfer								12P	12P								
MF Ød ₁	P	l ₁	l ₂	Ød ₂	a		Norm		NGMf								
							Tol.	INDEX	ISO2 (6H)	ISO2 (6H)							
M4,5x0,5	0,50	100	10	3,15	2,5	4,0	0046	o	o								
M5x0,5	0,50	110	10	3,55	2,8	4,5	0051	o	o								
M5,5x0,5	0,50	110	10	4,5	3,55	5,0	0056	o	o								
M6x0,75	0,75	120	16	4,5	3,55	5,2	0062	o	o								
M7x0,75	0,75	120	16	5,6	4,5	6,2	0072	o	o								
M8x0,75	0,75	140	16	6,3	5,0	7,2	0082	o	o								
M8x1	1,00	140	20	6,3	5,0	7,0	0083	●	o								
M10x0,75	0,75	160	16	8,0	6,3	9,2	0102	o	o								
M10x1	1,00	160	20	8,0	6,3	9,0	0103	●	o								
M10x1,25	1,25	160	25	8,0	6,3	8,8	0104	●	o								
M12x1	1,00	180	20	9,0	7,1	11,0	0123	●	o								
M12x1,25	1,25	180	25	9,0	7,1	10,8	0124	●	o								
M12x1,5	1,50	180	30	9,0	7,1	10,5	0125	●	o								
M14x1	1,00	180	20	10,0	8,0	13,0	0143	o	o								
M14x1,25	1,25	180	25	10,0	8,0	12,8	0144	●	o								
M14x1,5	1,50	180	30	10,0	8,0	12,5	0145	●	o								
M15x1	1,00	180	20	12,5	10,0	14,0	0153	o	o								
M15x1,5	1,50	180	30	12,5	10,0	13,5	0155	o	o								
M16x1	1,00	200	20	12,5	10,0	15,0	0163	o	o								
M16x1,5	1,50	200	30	12,5	10,0	14,5	0165	●	o								
M17x1	1,00	200	20	14,0	11,2	16,0	0173	o	o								
M17x1,5	1,50	200	30	14,0	11,2	15,5	0175	o	o								
M18x1	1,00	200	20	14,0	11,2	17,0	0183	o	o								
M18x1,5	1,50	200	30	14,0	11,2	16,5	0185	o	o								
M18x2	2,00	200	40	14,0	11,2	16,0	0186	o	o								
M20x1	1,00	220	20	16,0	12,5	19,0	0203	o	o								
M20x1,5	1,50	220	30	16,0	12,5	18,5	0205	●	o								
M20x2	2,00	220	40	16,0	12,5	18,0	0206	o	o								
M22x1	1,00	220	20	18,0	14,0	21,0	0223	o	o								
M22x1,5	1,50	220	30	18,0	14,0	20,5	0225	o	o								
M22x2	2,00	220	40	18,0	14,0	20,0	0226	o	o								
M24x1	1,00	250	20	18,0	14,0	23,0	0243	o	o								

- Available from stock
- On request

ISO	Vc (m/min)			
P	5-20	5-20		
M	-	-		
K	6-15	6-15		
N	6-15	6-15		
S	-	-		

1

ISO Metric fine thread DIN-13								NGMf											
 								LH											
Material groups								P M K	P M K										
Hole type																			
Quality of material								HSS	HSS										
Coating																			
Chamfer								12P	12P										
MF ød ₁	P	l ₁	l ₂	ød ₂	a		Norm		NGMf										
							Tol.	INDEX	ISO2 (6H)	ISO2 (6H)									
									F1-151001	F1-251001									
M24x1,5	1,50	250	30	18,0	14,0	22,5	0245	o	o										
M24x2	2,00	250	40	18,0	14,0	22,0	0246	o	o										
M25x1	1,00	250	20	20,0	16,0	24,0	0253	o	o										
M25x1,5	1,50	250	30	20,0	16,0	23,5	0255	o	o										
M25x2	2,00	250	40	20,0	16,0	23,0	0256	o	o										
M26x1,5	1,50	250	30	20,0	16,0	24,5	0265	o	o										
M27x1	1,00	250	20	20,0	16,0	26,0	0273	o	o										
M27x1,5	1,50	250	30	20,0	16,0	25,5	0275	o	o										
M27x2	2,00	250	40	20,0	16,0	25,0	0276	o	o										
M28x1	1,00	250	20	22,4	18,0	27,0	0283	o	o										
M28x1,5	1,50	250	30	22,4	18,0	26,5	0285	o	o										
M28x2	2,00	250	40	22,4	18,0	26,0	0286	o	o										
M30x1	1,00	280	20	22,4	18,0	29,0	0303	o	o										
M30x1,5	1,50	280	30	22,4	18,0	28,5	0305	o	o										
M30x2	2,00	280	40	22,4	18,0	28,0	0306	o	o										
M30x3	3,00	280	60	22,4	18,0	27,0	0307	o	o										
M32x1,5	1,50	280	30	25,0	20,0	30,5	0325	o	o										
M32x2	2,00	280	40	25,0	20,0	30,0	0326	o	o										
M33x1,5	1,50	280	30	25,0	20,0	31,5	0335	o	o										
M33x2	2,00	280	40	25,0	20,0	31,0	0336	o	o										
M33x3	3,00	280	60	25,0	20,0	30,0	0337	o	o										
M35x1,5	1,50	280	30	28,0	22,4	33,5	0355	o	o										
M36x1,5	1,50	280	30	28,0	22,4	34,5	0365	o	o										
M36x2	2,00	280	40	28,0	22,4	34,0	0366	o	o										
M36x3	3,00	280	60	28,0	22,4	33,0	0367	o	o										

ISO	Vc (m/min)			
P	5-20	5-20		
M	-	-		
K	6-15	6-15		
N	6-15	6-15		
S	-	-		



American unified coarse thread UNC, ANSI B-1.1											MASTER TAP																			
 <div style="display: flex; justify-content: space-around;"> <div style="border: 1px solid black; padding: 2px;">HSSE PM</div> <div style="border: 1px solid black; padding: 2px;">HL</div> <div style="border: 1px solid black; padding: 2px;">DIN 371</div> <div style="border: 1px solid black; padding: 2px;">DIN 376</div> </div>											B-HL		C-R45-HL																	
Material groups											<table border="1"> <tr><td>P</td><td>M</td><td>K</td></tr> <tr><td>N</td><td>S</td><td>H</td></tr> </table>		P	M	K	N	S	H	<table border="1"> <tr><td>P</td><td>M</td><td>K</td></tr> <tr><td>N</td><td>S</td><td>H</td></tr> </table>		P	M	K	N	S	H				
P	M	K																												
N	S	H																												
P	M	K																												
N	S	H																												
Hole type																														
Quality of material											HSSE-PM		HSSE-PM																	
Coating											HL		HL																	
Chamfer											B / 4-5P		C / 2-3P																	
UNC	Ød ₁	1"/P	P	l ₁	l ₂	l ₃	Ød ₂	a		Norm	DIN-371																			
										Tol.	2BX	2BX																		
										INDEX	C4-118M01	C4-528M01																		
No2-56	2,184	56	0,455	45	10	13	2,8	2,1	1,85	4102	○	○																		
No4-40	2,844	40	0,635	56	5	18	3,5	2,7	2,35	4104	●	●																		
No5-40	3,175	40	0,635	56	7	18	3,5	2,7	2,65	4105	●	●																		
No6-32	3,505	32	0,794	56	6	20	4,0	3,0	2,85	4106	●	●																		
No8-32	4,165	32	0,794	63	7	21	4,5	3,4	3,50	4108	●	●																		
No10-24	4,826	24	1,058	70	8	25	6,0	4,9	3,90	4110	●	●																		
No12-24	5,486	24	1,058	80	10	30	6,0	4,9	4,50	4112	●	●																		
1/4-20	6,350	20	1,270	80	13	32	7,0	5,5	5,10	4127	●	●																		
5/16-18	7,938	18	1,411	90	13	35	8,0	6,2	6,60	4128	●	●																		
3/8-16	9,525	16	1,588	100	15	39	10,0	8,0	8,00	4129	●	●																		
UNC	Ød ₁	1"/P	P	l ₁	l ₂	l ₃	Ød ₂	a		Norm	DIN-376																			
										Tol.	2BX	2BX																		
										INDEX	D4-118M01	D4-528M01																		
7/16-14	11,112	14	1,814	100	15	-	8,0	6,2	9,40	4130	●	●																		
1/2-13	12,700	13	1,954	110	18	-	9,0	7,0	10,80	4131	●	●																		
9/16-12	14,288	12	2,117	110	20	-	11,0	9,0	12,20	4132	●	●																		
5/8-11	15,875	11	2,309	110	22	-	12,0	9,0	13,50	4133	●	●																		
ISO											Vc (m/min)																			
P											5-40		5-40																	
M											5-15		5-15																	
K											10-30		10-30																	
N											10-30		10-30																	
S											1-8		1-8																	

1

American unified coarse thread UNC, ANSI B-1.1

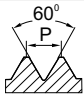

HSSE

TN2

DIN 371

DIN 376

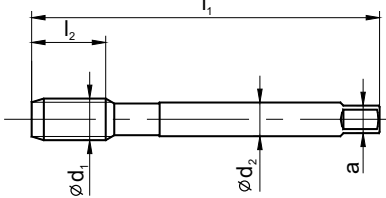
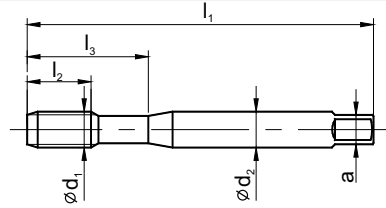

800X

B-TN2

C-R40-TN2



Material groups



Hole type



Quality of material

HSSE HSSE

Coating

TN2 TN2

Chamfer

B / 4-5P C / 2-3P

UNC	Ød ₁	1"/P	P	l ₁	l ₂	l ₂ R40	l ₃	Ød ₂	a		Norm	DIN-371	
											Tol.	2B	2B
											INDEX	C2-113X01	C2-513X01
No2-56	2,184	56	0,455	45	10	10	13	2,8	2,1	1,85	4102	○	○
No4-40	2,844	40	0,635	56	10	5	18	3,5	2,7	2,35	4104	●	●
No5-40	3,175	40	0,635	56	10	7	18	3,5	2,7	2,65	4105	●	●
No6-32	3,505	32	0,794	56	12	6	20	4,0	3,0	2,85	4106	●	●
No8-32	4,165	32	0,794	63	12	7	21	4,5	3,4	3,50	4108	●	●
No10-24	4,826	24	1,058	70	14	8	25	6,0	4,9	3,90	4110	●	●
No12-24	5,486	24	1,058	80	18	10	30	6,0	4,9	4,50	4112	●	●
1/4-20	6,350	20	1,270	80	18	13	32	7,0	5,5	5,10	4127	●	●
5/16-18	7,938	18	1,411	90	20	13	35	8,0	6,2	6,60	4128	●	●
3/8-16	9,525	16	1,588	100	20	15	39	10,0	8,0	8,00	4129	●	●

UNC	Ød ₁	1"/P	P	l ₁	l ₂	l ₂ R40	l ₃	Ød ₂	a		Norm	DIN-376	
											Tol.	2B	2B
											INDEX	D2-113X01	D2-513X01
7/16-14	11,112	14	1,814	100	22	15	-	8,0	6,2	9,40	4130	●	●
1/2-13	12,700	13	1,954	110	24	18	-	9,0	7,0	10,80	4131	●	●
9/16-12	14,288	12	2,117	110	25	20	-	11,0	9,0	12,20	4132	●	●
5/8-11	15,875	11	2,309	110	32	22	-	12,0	9,0	13,50	4133	●	●
3/4-10	19,050	10	2,540	125	32	25	-	14,0	11,0	16,50	4135	●	●
7/8-9	22,225	9	2,822	140	32	30	-	18,0	14,5	19,50	4137	●	●
1-8	25,400	8	3,175	160	38	30	-	20,0	16,0	22,25	4139	●	●
1.1/8-7	28,575	7	3,629	180	45	37	-	22,0	18,0	25,00	4141	○	○
1.1/4-7	31,750	7	3,629	180	45	37	-	22,0	18,0	28,00	4143	○	○
1.3/8-6	34,925	6	4,233	200	50	40	-	28,0	22,0	30,75	4145	○	○
1.1/2-6	38,100	6	4,233	200	55	40	-	28,0	22,0	34,00	4147	○	○

ISO	Vc (m/min)		
P	5-35	5-35	
M	5-15	5-15	
K	5-25	5-25	
N	10-30	10-30	
S	-	-	



American unified coarse thread UNC, ANSI B-1.1											800						
											B	C-R40					
<div style="display: flex; justify-content: space-around;"> <div style="border: 1px solid black; padding: 2px;">HSSE</div> <div style="border: 1px solid black; padding: 2px;">DIN 371</div> <div style="border: 1px solid black; padding: 2px;">DIN 376</div> </div>											<div style="display: flex; justify-content: space-around;"> <div style="border: 1px solid black; padding: 2px;">P M K</div> <div style="border: 1px solid black; padding: 2px;">P M K</div> </div>						
Material groups											<div style="display: flex; justify-content: space-around;"> <div style="border: 1px solid black; padding: 2px;">P M K</div> <div style="border: 1px solid black; padding: 2px;">P M K</div> </div>						
Hole type											<div style="display: flex; justify-content: space-around;"> <div style="border: 1px solid black; padding: 2px;">< 3d</div> <div style="border: 1px solid black; padding: 2px;">< 2,5d</div> </div>						
Quality of material											HSSE						
Coating																	
Chamfer											B / 4-5P C / 2-3P						
UNC	Ød ₁	1"/P	P	l ₁	l ₂	l ₂ R40	l ₃	Ød ₂	a		Norma	DIN-371					
											Tol.	2B	2B				
											INDEX	C2-111101	C2-511101				
No2-56	2,184	56	0,455	45	10	10	13	2,8	2,1	1,85	4102	○	○				
No4-40	2,844	40	0,635	56	10	5	18	3,5	2,7	2,35	4104	●	●				
No5-40	3,175	40	0,635	56	10	7	18	3,5	2,7	2,65	4105	●	●				
No6-32	3,505	32	0,794	56	12	6	20	4,0	3,0	2,85	4106	●	●				
No8-32	4,165	32	0,794	63	12	7	21	4,5	3,4	3,50	4108	●	●				
No10-24	4,826	24	1,058	70	14	8	25	6,0	4,9	3,90	4110	●	●				
No12-24	5,486	24	1,058	80	18	10	30	6,0	4,9	4,50	4112	●	●				
1/4-20	6,350	20	1,270	80	18	13	32	7,0	5,5	5,10	4127	●	●				
5/16-18	7,938	18	1,411	90	20	13	35	8,0	6,2	6,60	4128	●	●				
3/8-16	9,525	16	1,588	100	20	15	39	10,0	8,0	8,00	4129	●	●				
UNC	Ød ₁	1"/P	P	l ₁	l ₂	l ₂ R40	l ₃	Ød ₂	a		Norm	DIN-376					
											Tol.	2B	2B				
											INDEX	D2-111101	D2-511101				
7/16-14	11,112	14	1,814	100	22	15	-	8,0	6,2	9,40	4130	●	●				
1/2-13	12,700	13	1,954	110	24	18	-	9,0	7,0	10,80	4131	●	●				
9/16-12	14,288	12	2,117	110	25	20	-	11,0	9,0	12,20	4132	●	●				
5/8-11	15,875	11	2,309	110	32	22	-	12,0	9,0	13,50	4133	●	●				
3/4-10	19,050	10	2,540	125	32	25	-	14,0	11,0	16,50	4135	●	●				
7/8-9	22,225	9	2,822	140	32	30	-	18,0	14,5	19,50	4137	●	●				
1-8	25,400	8	3,175	160	38	30	-	20,0	16,0	22,25	4139	●	●				
1.1/8-7	28,575	7	3,629	180	45	37	-	22,0	18,0	25,00	4141	●	●				
1.1/4-7	31,750	7	3,629	180	45	37	-	22,0	18,0	28,00	4143	●	●				
1.3/8-6	34,925	6	4,233	200	50	40	-	28,0	22,0	30,75	4145	●	●				
1.1/2-6	38,100	6	4,233	200	55	40	-	28,0	22,0	34,00	4147	●	●				
ISO											Vc (m/min)						
P											5-20	5-20					
M											5-10	5-10					
K											5-15	5-15					
N											5-25	5-25					
S											-	-					

1

American unified coarse thread UNC, ANSI B-1.1

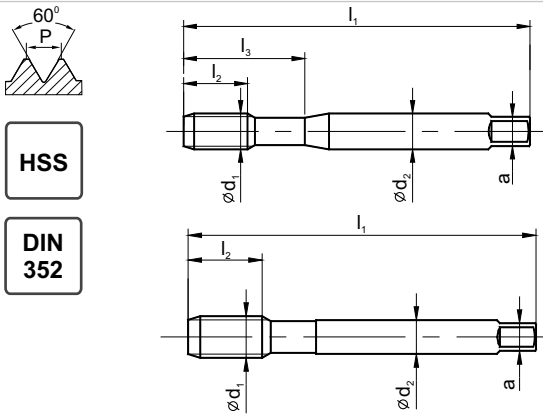

HSS

DIN 352



Material groups



Hole type



Quality of material

HSS

Coating

Chamfer

~3P

UNC	Ød ₁	1"/P	P	l ₁	l ₂	l ₃	Ød ₂	a		Norma					
										DIN-352					
										ToI.	2B				
										INDEX	E1-131001				
No4-40	2,844	40	0,635	40	10	18	3,5	2,7	2,35	4104	○				
No5-40	3,175	40	0,640	42	10	18	3,5	2,7	2,65	4105	○				
No6-32	3,505	32	0,794	45	11	18	4,0	3,0	2,85	4106	●				
No8-32	4,166	32	0,794	48	12	23	4,5	3,4	3,50	4108	○				
No10-24	4,826	24	1,060	52	14	26	6,0	4,9	3,90	4110	○				
No12-24	5,486	24	1,060	56	16	27	6,0	4,9	4,50	4112	○				
1/4-20	6,350	20	1,270	56	16	27	6,0	4,9	5,20	4127	●				
5/16-18	7,938	18	1,411	63	20	-	6,0	4,9	6,60	4128	●				
3/8-16	9,525	16	1,588	70	22	-	7,0	5,5	8,00	4129	●				
7/16-14	11,112	14	1,814	70	22	-	8,0	6,2	9,40	4130	○				
1/2-13	12,700	13	1,954	80	25	-	9,0	7,0	10,80	4131	●				
9/16-12	14,288	12	2,117	80	26	-	11,0	9,0	12,20	4132	○				
5/8-11	15,875	11	2,309	80	27	-	12,0	9,0	13,50	4133	●				
3/4-10	19,050	10	2,540	95	30	-	14,0	11,0	16,50	4135	●				
7/8-9	22,225	9	2,822	100	32	-	18,0	14,5	19,50	4137	○				
1-8	25,400	8	3,175	110	36	-	18,0	14,5	22,25	4139	○				
1.1/8-7	28,575	7	3,629	125	40	-	22,0	18,0	25,00	4141	○				
1.1/4-7	31,750	7	3,629	125	40	-	22,0	18,0	28,00	4143	○				
1.3/8-6	34,925	6	4,233	150	50	-	28,0	22,0	30,75	4145	○				
1.1/2-6	38,100	6	4,233	150	50	-	28,0	22,0	34,00	4147	○				
1.3/4-5	44,450	5	5,080	160	58	-	36,0	29,0	39,50	4151	○				
2-4.1/2	50,800	4 1/2	5,644	180	65	-	40,0	32,0	45,00	4155	○				

ISO	Vc (m/min)				
P	5-20				
M	-				
K	-				
N	-				
S	-				

American unified fine thread UNF, ANSI B-1.1											MASTER TAP						
											B-HL	C-R45-HL					
<div style="display: flex; flex-direction: column; align-items: flex-start;"> <div style="border: 1px solid black; padding: 2px; margin-bottom: 5px;">HSSE PM</div> <div style="border: 1px solid black; padding: 2px; margin-bottom: 5px;">HL</div> <div style="border: 1px solid black; padding: 2px;">DIN 371</div> </div>											<div style="display: flex; justify-content: space-around;"> <div style="display: flex; flex-wrap: wrap;"> <div style="border: 1px solid black; padding: 1px; margin: 1px;">P</div> <div style="border: 1px solid black; padding: 1px; margin: 1px;">M</div> <div style="border: 1px solid black; padding: 1px; margin: 1px;">K</div> </div> <div style="display: flex; flex-wrap: wrap;"> <div style="border: 1px solid black; padding: 1px; margin: 1px;">N</div> <div style="border: 1px solid black; padding: 1px; margin: 1px;">S</div> <div style="border: 1px solid black; padding: 1px; margin: 1px;">H</div> </div> </div>						
Material groups											<div style="display: flex; justify-content: space-around;"> <div style="display: flex; flex-wrap: wrap;"> <div style="border: 1px solid black; padding: 1px; margin: 1px;">P</div> <div style="border: 1px solid black; padding: 1px; margin: 1px;">M</div> <div style="border: 1px solid black; padding: 1px; margin: 1px;">K</div> </div> <div style="display: flex; flex-wrap: wrap;"> <div style="border: 1px solid black; padding: 1px; margin: 1px;">N</div> <div style="border: 1px solid black; padding: 1px; margin: 1px;">S</div> <div style="border: 1px solid black; padding: 1px; margin: 1px;">H</div> </div> </div>						
Hole type											<div style="display: flex; justify-content: space-around;"> <div style="border: 1px solid black; padding: 2px; text-align: center;"> < 3d </div> <div style="border: 1px solid black; padding: 2px; text-align: center;"> < 2.5d </div> </div>						
Quality of material											HSSE-PM	HSSE-PM					
Coating											HL	HL					
Chamfer											B / 4-5P	C / 2-3P					
UNF	Ød ₁	1"/P	P	l ₁	l ₂	l ₃	Ød ₂	a		Norma	DIN-371						
										Tol.	2BX	2BX					
										INDEX	C4-118M01	C4-528M01					
No4-48	2,844	48	0,529	56	5	18	3,5	2,7	2,40	4204	●	●					
No5-44	3,175	44	0,557	56	7	18	3,5	2,7	2,70	4205	●	●					
No6-40	3,505	40	0,635	56	6	20	4,0	3,0	2,95	4206	●	●					
No8-36	4,165	36	0,706	63	7	21	4,5	3,4	3,50	4208	●	●					
No10-32	4,826	32	0,794	70	8	25	6,0	4,9	4,10	4210	●	●					
No12-28	5,486	28	0,907	80	10	30	6,0	4,9	4,60	4212	●	●					
1/4-28	6,350	28	0,907	80	10	30	7,0	5,5	5,50	4227	●	●					
5/16-24	7,938	24	1,058	90	13	35	8,0	6,2	6,90	4228	●	●					
3/8-24	9,525	24	1,058	90	15	35	10,0	8,0	8,50	4229	●	●					
UNF	Ød ₁	1"/P	P	l ₁	l ₂	l ₃	Ød ₂	a		Norm	DIN-374						
										Tol.	2BX	2BX					
										INDEX	D4-118M01	D4-528M01					
7/16-20	11,112	20	1,270	100	15	-	8,0	6,2	9,90	4230	●	●					
1/2-20	12,700	20	1,270	100	15	-	9,0	7,0	11,50	4231	●	●					
9/16-18	14,288	18	1,411	100	15	-	11,0	9,0	12,90	4232	●	●					
5/8-18	15,875	18	1,411	100	15	-	12,0	9,0	14,50	4233	●	●					
											ISO		Vc (m/min)				
											P	5-40	5-40				
											M	5-15	5-15				
											K	10-30	10-30				
											N	10-30	10-30				
											S	1-8	1-8				

1

American unified fine thread UNF, ANSI B-1.1

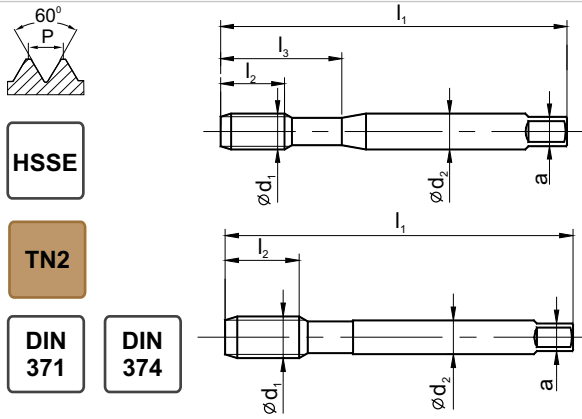

HSSE

TN2

DIN 371

DIN 374

800X

B-TN2

C-R40-TN2



Material groups



Hole type



Quality of material

HSSE HSSE

Coating

TN2 TN2

Chamfer

B / 4-5P C / 2-3P

UNF	Ød ₁	1"/P	P	l ₁	l ₂	l ₂ R40	l ₃	Ød ₂	a		Norma	DIN-371	
											Tol.	2B	2B
											INDEX	C2-113X01	C2-513X01
No6-40	3,505	40	0,635	56	12	6	20	4,0	3,0	2,95	4206	○	○
No8-36	4,165	36	0,706	63	12	7	21	4,5	3,4	3,50	4208	○	○
No10-32	4,826	32	0,794	70	14	8	25	6,0	4,9	4,10	4210	●	●
No12-28	5,486	28	0,907	80	18	10	30	6,0	4,9	4,60	4212	●	●
1/4-28	6,350	28	0,907	80	18	10	30	7,0	5,5	5,50	4227	●	●
5/16-24	7,938	24	1,058	90	20	13	35	8,0	6,2	6,90	4228	●	●
3/8-24	9,525	24	1,058	90	20	15	35	10,0	8,0	8,50	4229	●	●

UNF	Ød ₁	1"/P	P	l ₁	l ₂	l ₂ R40	l ₃	Ød ₂	a		Norm	DIN-374	
											Tol.	2B	2B
											INDEX	D2-113X01	D2-513X01
7/16-20	11,112	20	1,270	100	20	15	-	8,0	6,2	9,90	4230	●	●
1/2-20	12,700	20	1,270	100	20	15	-	9,0	7,0	11,50	4231	●	●
9/16-18	14,288	18	1,411	100	20	15	-	11,0	9,0	12,90	4232	●	●
5/8-18	15,875	18	1,411	100	20	15	-	12,0	9,0	14,50	4233	●	●
3/4-16	19,050	16	1,588	110	24	17	-	14,0	11,0	17,50	4235	●	●
7/8-14	22,225	14	1,814	125	24	17	-	18,0	14,5	20,40	4237	●	●
1-12	25,400	12	2,117	140	27	22	-	18,0	14,5	23,25	4239	●	●
1.1/8-12	28,575	12	2,117	150	27	22	-	22,0	18,0	26,50	4241	○	○
1.1/4-12	31,750	12	2,117	150	27	22	-	22,0	18,0	29,50	4243	○	○
1.3/8-12	34,925	12	2,117	170	30	22	-	28,0	22,0	32,75	4245	○	○
1.1/2-12	38,100	12	2,117	170	30	24	-	28,0	22,0	36,00	4247	○	○

ISO	V _c (m/min)	
P	5-35	5-35
M	5-15	5-15
K	5-25	10-25
N	10-30	10-30
S	-	-

800X



American unified fine thread UNF, ANSI B-1.1												800																			
												B		C-R40																	
Material groups												<table border="1"> <tr><td>P</td><td>M</td><td>K</td></tr> <tr><td>N</td><td>S</td><td>H</td></tr> </table>		P	M	K	N	S	H	<table border="1"> <tr><td>P</td><td>M</td><td>K</td></tr> <tr><td>N</td><td>S</td><td>H</td></tr> </table>		P	M	K	N	S	H				
P	M	K																													
N	S	H																													
P	M	K																													
N	S	H																													
Hole type																															
Quality of material												HSSE		HSSE																	
Coating																															
Chamfer												B / 4-5P		C / 2-3P																	
UNF	Ød ₁	1"/P	P	l ₁	l ₂	l ₂ R40	l ₃	Ød ₂	a		Norma	DIN-371																			
											Tol.	2B	2B																		
											INDEX	C2-111101	C2-511101																		
No6-40	3,505	40	0,635	56	12	6	20	4,0	3,0	2,95	4206	○	○																		
No8-36	4,165	36	0,706	63	12	7	21	4,5	3,4	3,50	4208	○	○																		
No10-32	4,826	32	0,794	70	14	8	25	6,0	4,9	4,10	4210	●	●																		
No12-28	5,486	28	0,907	80	18	10	30	6,0	4,9	4,60	4212	●	●																		
1/4-28	6,350	28	0,907	80	18	10	30	7,0	5,5	5,50	4227	●	●																		
5/16-24	7,938	24	1,058	90	20	13	35	8,0	6,2	6,90	4228	●	●																		
3/8-24	9,525	24	1,058	90	20	15	35	10,0	8,0	8,50	4229	●	●																		

UNF	Ød ₁	1"/P	P	l ₁	l ₂	l ₂ R40	l ₃	Ød ₂	a		Norm	DIN-374					
											Tol.	2B	2B				
											INDEX	D2-111101	D2-511101				
7/16-20	11,112	20	1,270	100	20	15	-	8,0	6,2	9,90	4230	●	●				
1/2-20	12,700	20	1,270	100	20	15	-	9,0	7,0	11,50	4231	●	●				
9/16-18	14,288	18	1,411	100	20	15	-	11,0	9,0	12,90	4232	●	●				
5/8-18	15,875	18	1,411	100	20	15	-	12,0	9,0	14,50	4233	●	●				
3/4-16	19,050	16	1,588	110	24	17	-	14,0	11,0	17,50	4235	●	●				
7/8-14	22,225	14	1,814	125	24	17	-	18,0	14,5	20,40	4237	●	●				
1-12	25,400	12	2,117	140	27	22	-	18,0	14,5	23,25	4239	●	●				
1.1/8-12	28,575	12	2,117	150	27	22	-	22,0	18,0	26,50	4241	○	○				
1.1/4-12	31,750	12	2,117	150	27	22	-	22,0	18,0	29,50	4243	○	○				
1.3/8-12	34,925	12	2,117	170	30	22	-	28,0	22,0	32,75	4245	○	○				
1.1/2-12	38,100	12	2,117	170	30	24	-	28,0	22,0	36,00	4247	○	○				
ISO												Vc (m/min)					
P												5-20	5-20				
M												5-10	5-10				
K												5-15	5-15				
N												5-25	5-25				
S												-	-				

1

American unified fine thread UNF, ANSI B-1.1



HSS

DIN 2181

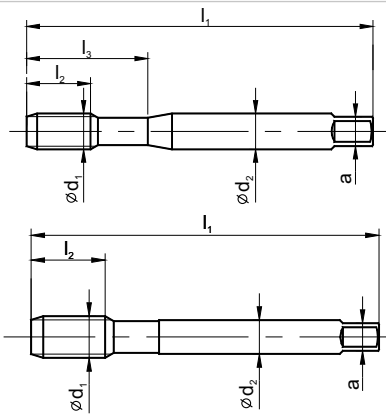

Material groups



Hole type



Quality of material

HSS

Coating

Chamfer

~3P

UNF	ød ₁	1"/P	P	l ₁	l ₂	l ₃	ød ₂	a		Norma					
										DIN-2181					
										Tol.	2B				
INDEX											E1-131001				
No5-44	3,175	44	0,577	42	10	18	3,5	2,7	2,70	4205	○				
No6-40	3,505	40	0,635	45	11	18	4,0	3,0	2,95	4206	○				
No8-36	4,165	36	0,706	48	12	23	4,5	3,4	3,50	4208	○				
No10-32	4,826	32	0,794	52	14	22	6,0	4,9	4,10	4210	○				
No12-28	5,486	28	0,907	56	16	24	6,0	4,9	4,60	4212	○				
1/4-28	6,350	28	0,907	56	16	24	6,0	4,9	5,50	4227	●				
5/16-24	7,938	24	1,058	63	17	-	6,0	4,9	6,90	4228	●				
3/8-24	9,525	24	1,058	63	18	-	7,0	5,5	8,50	4229	●				
7/16-20	11,112	20	1,270	70	22	-	8,0	6,2	9,90	4230	●				
1/2-20	12,700	20	1,270	70	20	-	9,0	7,0	11,50	4231	●				
9/16-18	14,288	18	1,411	80	20	-	11,0	9,0	12,90	4232	●				
5/8-18	15,875	18	1,411	80	20	-	12,0	9,0	14,50	4233	●				
3/4-16	16,050	16	1,588	80	22	-	14,0	11,0	17,50	4235	●				
7/8-14	22,225	14	1,814	80	22	-	18,0	14,5	20,40	4237	○				
1-12	25,400	12	2,117	90	22	-	18,0	14,5	23,25	4239	○				
1.1/8-12	28,575	12	2,117	90	22	-	22,0	18,0	26,50	4241	○				
1.1/4-12	31,750	12	2,117	90	22	-	22,0	18,0	29,50	4243	○				
1.3/8-12	34,925	12	2,117	125	36	-	28,0	22,0	32,75	4245	○				
1.1/2-12	38,100	12	2,117	125	36	-	28,0	22,0	36,00	4247	○				

ISO	Vc (m/min)				
P	5-20				
M	-				
K	-				
N	-				
S	-				

American unified fine thread UNEF, ANSI B-1.1												800X																																																																																																																																																																																																																																									
 <div style="display: flex; flex-direction: column; gap: 5px;"> <div style="border: 1px solid black; padding: 2px; width: fit-content;">HSSE</div> <div style="border: 1px solid black; padding: 2px; width: fit-content;">TN2</div> <div style="border: 1px solid black; padding: 2px; width: fit-content;">DIN ~374</div> </div>												B-TN2		C-R40-TN2																																																																																																																																																																																																																																							
Material groups												<table border="1"> <tr><td>P</td><td>M</td><td>K</td></tr> <tr><td>N</td><td>S</td><td>H</td></tr> </table>		P	M	K	N	S	H	<table border="1"> <tr><td>P</td><td>M</td><td>K</td></tr> <tr><td>N</td><td>S</td><td>H</td></tr> </table>		P	M	K	N	S	H																																																																																																																																																																																																																										
P	M	K																																																																																																																																																																																																																																																			
N	S	H																																																																																																																																																																																																																																																			
P	M	K																																																																																																																																																																																																																																																			
N	S	H																																																																																																																																																																																																																																																			
Hole type												<table border="1"> <tr><td></td><td></td></tr> </table>																																																																																																																																																																																																																																									
Quality of material												HSSE																																																																																																																																																																																																																																									
Coating												TN2																																																																																																																																																																																																																																									
Chamfer												B / 4-5P		C / 2-3P																																																																																																																																																																																																																																							
<table border="1"> <thead> <tr> <th rowspan="2">UNEF</th> <th rowspan="2">Ød₁</th> <th rowspan="2">1"/P</th> <th rowspan="2">P</th> <th rowspan="2">l₁</th> <th rowspan="2">l₂</th> <th rowspan="2">l₂ R40</th> <th rowspan="2">l₃</th> <th rowspan="2">Ød₂</th> <th rowspan="2">a</th> <th rowspan="2"></th> <th>Norma</th> <th colspan="2">~DIN-374</th> <th></th> <th></th> <th></th> <th></th> </tr> <tr> <th>Tol.</th> <th>2B</th> <th>2B</th> <th></th> <th></th> <th></th> <th></th> </tr> <tr> <th colspan="12"></th> <th>INDEX</th> <th>D2-113X01</th> <th>D2-513X01</th> <th></th> <th></th> <th></th> <th></th> </tr> </thead> <tbody> <tr><td>1/4-32</td><td>6,350</td><td>32</td><td>0,794</td><td>80</td><td>14</td><td>8</td><td>-</td><td>4,5</td><td>3,4</td><td>5,55</td><td>4327</td><td>o</td><td>o</td><td></td><td></td><td></td><td></td></tr> <tr><td>5/16-32</td><td>7,938</td><td>32</td><td>0,794</td><td>80</td><td>14</td><td>8</td><td>-</td><td>6,0</td><td>4,9</td><td>7,15</td><td>4328</td><td>o</td><td>o</td><td></td><td></td><td></td><td></td></tr> <tr><td>3/8-32</td><td>9,525</td><td>32</td><td>0,794</td><td>90</td><td>18</td><td>8</td><td>-</td><td>7,0</td><td>5,5</td><td>8,70</td><td>4329</td><td>o</td><td>o</td><td></td><td></td><td></td><td></td></tr> <tr><td>7/16-28</td><td>11,112</td><td>28</td><td>0,907</td><td>90</td><td>18</td><td>10</td><td>-</td><td>8,0</td><td>6,2</td><td>10,20</td><td>4330</td><td>o</td><td>o</td><td></td><td></td><td></td><td></td></tr> <tr><td>1/2-28</td><td>12,700</td><td>28</td><td>0,907</td><td>100</td><td>18</td><td>10</td><td>-</td><td>9,0</td><td>7,0</td><td>11,80</td><td>4331</td><td>o</td><td>o</td><td></td><td></td><td></td><td></td></tr> <tr><td>9/16-24</td><td>14,288</td><td>24</td><td>1,058</td><td>100</td><td>18</td><td>11</td><td>-</td><td>11,0</td><td>9,0</td><td>13,20</td><td>4332</td><td>o</td><td>o</td><td></td><td></td><td></td><td></td></tr> <tr><td>5/8-24</td><td>15,875</td><td>24</td><td>1,058</td><td>100</td><td>18</td><td>11</td><td>-</td><td>12,0</td><td>9,0</td><td>14,80</td><td>4333</td><td>o</td><td>o</td><td></td><td></td><td></td><td></td></tr> <tr><td>3/4-20</td><td>19,050</td><td>20</td><td>1,270</td><td>110</td><td>25</td><td>13</td><td>-</td><td>14,0</td><td>11,0</td><td>17,80</td><td>4335</td><td>o</td><td>o</td><td></td><td></td><td></td><td></td></tr> <tr><td>7/8-20</td><td>22,225</td><td>20</td><td>1,270</td><td>125</td><td>25</td><td>13</td><td>-</td><td>18,0</td><td>14,5</td><td>20,95</td><td>4337</td><td>o</td><td>o</td><td></td><td></td><td></td><td></td></tr> <tr><td>1-20</td><td>25,400</td><td>20</td><td>1,270</td><td>140</td><td>28</td><td>13</td><td>-</td><td>18,0</td><td>14,5</td><td>24,15</td><td>4339</td><td>o</td><td>o</td><td></td><td></td><td></td><td></td></tr> </tbody> </table>												UNEF	Ød ₁	1"/P	P	l ₁	l ₂	l ₂ R40	l ₃	Ød ₂	a		Norma	~DIN-374						Tol.	2B	2B																	INDEX	D2-113X01	D2-513X01					1/4-32	6,350	32	0,794	80	14	8	-	4,5	3,4	5,55	4327	o	o					5/16-32	7,938	32	0,794	80	14	8	-	6,0	4,9	7,15	4328	o	o					3/8-32	9,525	32	0,794	90	18	8	-	7,0	5,5	8,70	4329	o	o					7/16-28	11,112	28	0,907	90	18	10	-	8,0	6,2	10,20	4330	o	o					1/2-28	12,700	28	0,907	100	18	10	-	9,0	7,0	11,80	4331	o	o					9/16-24	14,288	24	1,058	100	18	11	-	11,0	9,0	13,20	4332	o	o					5/8-24	15,875	24	1,058	100	18	11	-	12,0	9,0	14,80	4333	o	o					3/4-20	19,050	20	1,270	110	25	13	-	14,0	11,0	17,80	4335	o	o					7/8-20	22,225	20	1,270	125	25	13	-	18,0	14,5	20,95	4337	o	o					1-20	25,400	20	1,270	140	28	13	-	18,0	14,5	24,15	4339	o	o					ISO		V _c (m/min)							
																							UNEF	Ød ₁	1"/P	P	l ₁	l ₂	l ₂ R40	l ₃	Ød ₂	a		Norma	~DIN-374																																																																																																																																																																																																																		
Tol.	2B	2B																																																																																																																																																																																																																																																			
												INDEX	D2-113X01	D2-513X01																																																																																																																																																																																																																																							
1/4-32	6,350	32	0,794	80	14	8	-	4,5	3,4	5,55	4327	o	o																																																																																																																																																																																																																																								
5/16-32	7,938	32	0,794	80	14	8	-	6,0	4,9	7,15	4328	o	o																																																																																																																																																																																																																																								
3/8-32	9,525	32	0,794	90	18	8	-	7,0	5,5	8,70	4329	o	o																																																																																																																																																																																																																																								
7/16-28	11,112	28	0,907	90	18	10	-	8,0	6,2	10,20	4330	o	o																																																																																																																																																																																																																																								
1/2-28	12,700	28	0,907	100	18	10	-	9,0	7,0	11,80	4331	o	o																																																																																																																																																																																																																																								
9/16-24	14,288	24	1,058	100	18	11	-	11,0	9,0	13,20	4332	o	o																																																																																																																																																																																																																																								
5/8-24	15,875	24	1,058	100	18	11	-	12,0	9,0	14,80	4333	o	o																																																																																																																																																																																																																																								
3/4-20	19,050	20	1,270	110	25	13	-	14,0	11,0	17,80	4335	o	o																																																																																																																																																																																																																																								
7/8-20	22,225	20	1,270	125	25	13	-	18,0	14,5	20,95	4337	o	o																																																																																																																																																																																																																																								
1-20	25,400	20	1,270	140	28	13	-	18,0	14,5	24,15	4339	o	o																																																																																																																																																																																																																																								
												P	5-35	5-35																																																																																																																																																																																																																																							
												M	5-15	5-15																																																																																																																																																																																																																																							
												K	5-25	10-25																																																																																																																																																																																																																																							
												N	10-30	10-30																																																																																																																																																																																																																																							
												S	-	-																																																																																																																																																																																																																																							

1

American unified fine thread UNEF, ANSI B-1.1											800									
 											B		C-R40							
Material groups																				
Hole type																				
Quality of material											HSSE	HSSE								
Coating																				
Chamfer											B / 4-5P	C / 2-3P								
											Norma	~DIN-374								
											Tol.	2B	2B							
											INDEX	D2-111101	D2-511101							
UNEF	Ød ₁	1"/P	P	l ₁	l ₂	l ₂ R40	l ₃	Ød ₂	a											
1/4-32	6,350	32	0,794	80	14	8	-	4,5	3,4	5,55	4327	o	o							
5/16-32	7,938	32	0,794	80	14	8	-	6,0	4,9	7,15	4328	o	o							
3/8-32	9,525	32	0,794	90	18	8	-	7,0	5,5	8,70	4329	o	o							
7/16-28	11,112	28	0,907	90	18	10	-	8,0	6,2	10,20	4330	o	o							
1/2-28	12,700	28	0,907	100	18	10	-	9,0	7,0	11,80	4331	o	o							
9/16-24	14,288	24	1,058	100	18	11	-	11,0	9,0	13,20	4332	o	o							
5/8-24	15,875	24	1,058	100	18	11	-	12,0	9,0	14,80	4333	o	o							
3/4-20	19,050	20	1,270	110	25	13	-	14,0	11,0	17,80	4335	o	o							
7/8-20	22,225	20	1,270	125	25	13	-	18,0	14,5	20,95	4337	o	o							
1-20	25,400	20	1,270	140	28	13	-	18,0	14,5	24,15	4339	o	o							
											ISO	V _c (m/min)								
											P	5-20	5-20							
											M	5-10	5-10							
											K	5-15	5-15							
											N	5-25	5-25							
											S	-	-							



American unified coarse thread for aerospace industry UNJC ASME B1.15										1400-HT					
										B-TS	C-R15-TS				
Material groups															
Hole type															
Quality of material										HSSE-PM	HSSE-PM				
Coating										TS	TS				
Chamfer										B / 4-5P	C / 2-3P				
UNJC	Ød ₁	P	l ₁	l ₂	l ₃	Ød ₂	a		Norma	DIN-371					
									Tol.	3BX	3BX				
									INDEX	C4-11G902	C4-50G902				
No4-40	2,844	40	56	10	18	3,5	2,7	2,35	4004	o	o				
No6-32	3,505	32	56	12	20	4,0	3,0	2,85	4006	o	o				
No8-32	4,165	32	63	12	21	4,5	3,4	3,50	4008	o	o				
No10-24	4,826	24	70	14	25	6,0	4,9	3,90	4010	o	o				
1/4-20	6,350	20	80	18	32	7,0	5,5	5,10	4027	o	o				
5/16-18	7,938	18	90	20	35	8,0	6,0	6,60	4028	o	o				
3/8-16	9,525	16	100	20	39	10,0	8,0	8,00	4029	o	o				
UNJC	Ød ₁	P	l ₁	l ₂	l ₃	Ød ₂	a		Norma	DIN-376					
									Tol.	3BX	3BX				
									INDEX	D4-11G902	D4-50G902				
7/16-14	11,112	14	100	22	-	8,0	6,2	9,40	4030	o	o				

1

American unified fine thread for aerospace industry UNJF ASME B1.15

I400-HT

B-TS C-R15-TS



HSSE
PM

TS

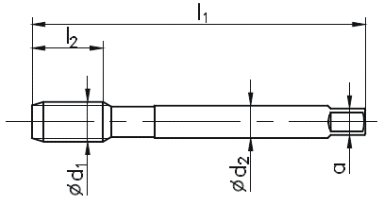
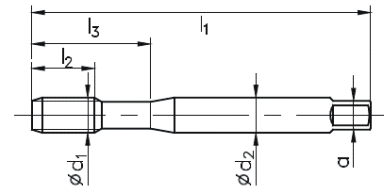

Material groups



Hole type



Quality of material

HSSE-PM HSSE-PM

Coating

TS TS

Chamfer

B / 4-5P C / 2-3P

UNJF	$\varnothing d_1$	P	l_1	l_2	l_3	$\varnothing d_2$	a		Norma			
									DIN-371			
									Tol.	3BX	3BX	
										INDEX	C4-11G902	C4-50G902
No6-40	3,505	40	56	12	20	4,0	3,0	2,95	4906	o	o	
No8-36	4,165	36	63	12	21	4,5	3,4	3,50	4908	o	o	
No10-32	4,826	32	70	14	25	6,0	4,9	4,10	4910	o	o	
1/4-28	6,350	28	80	18	32	7,0	5,5	5,50	4927	o	o	
5/16-24	7,938	24	90	20	35	8,0	6,0	6,90	4928	o	o	
3/8-24	9,525	24	100	20	39	10,0	8,0	8,50	4929	o	o	

UNJF	$\varnothing d_1$	P	l_1	l_2	l_3	$\varnothing d_2$	a		Norma			
									DIN-374			
									Tol.	3BX	3BX	
										INDEX	D4-11G902	D4-50G902
7/16-20	11,112	20	100	20	-	8,0	6,2	9,40	4930	o	o	

Whitworth pipe thread G, DIN-ISO 228										MASTER TAP																																																																																																											
 <div style="display: flex; flex-direction: column; gap: 5px;"> <div style="border: 1px solid black; padding: 2px; width: fit-content;">HSSE PM</div> <div style="border: 1px solid black; padding: 2px; width: fit-content;">HL</div> <div style="border: 1px solid black; padding: 2px; width: fit-content;">DIN 5156</div> </div>										B-HL		C-R45-HL																																																																																																									
Material groups										<table border="1"> <tr><td>P</td><td>M</td><td>K</td></tr> <tr><td>N</td><td>S</td><td>H</td></tr> </table>		P	M	K	N	S	H	<table border="1"> <tr><td>P</td><td>M</td><td>K</td></tr> <tr><td>N</td><td>S</td><td>H</td></tr> </table>		P	M	K	N	S	H																																																																																												
P	M	K																																																																																																																			
N	S	H																																																																																																																			
P	M	K																																																																																																																			
N	S	H																																																																																																																			
Hole type										<table border="1"> <tr><td></td><td></td></tr> </table>																																																																																																											
Quality of material										HSSE-PM		HSSE-PM																																																																																																									
Coating										HL		HL																																																																																																									
Chamfer										B / 4-5P		C / 2-3P																																																																																																									
<table border="1"> <thead> <tr> <th>G</th> <th>Ød₁</th> <th>1"/P</th> <th>P</th> <th>l₁</th> <th>l₂</th> <th>l₃</th> <th>Ød₂</th> <th>a</th> <th></th> </tr> </thead> <tbody> <tr><td>G1/16</td><td>7,723</td><td>28</td><td>0,907</td><td>90</td><td>10</td><td>-</td><td>6,0</td><td>4,9</td><td>6,80</td></tr> <tr><td>G1/8</td><td>9,728</td><td>28</td><td>0,907</td><td>90</td><td>10</td><td>-</td><td>7,0</td><td>5,5</td><td>8,80</td></tr> <tr><td>G1/4</td><td>13,157</td><td>19</td><td>1,337</td><td>100</td><td>14</td><td>-</td><td>11,0</td><td>9,0</td><td>11,80</td></tr> <tr><td>G3/8</td><td>16,662</td><td>19</td><td>1,337</td><td>100</td><td>15</td><td>-</td><td>12,0</td><td>9,0</td><td>15,25</td></tr> <tr><td>G1/2</td><td>20,955</td><td>14</td><td>1,814</td><td>125</td><td>17</td><td>-</td><td>16,0</td><td>12,0</td><td>19,00</td></tr> <tr><td>G5/8</td><td>22,911</td><td>14</td><td>1,814</td><td>125</td><td>20</td><td>-</td><td>18,0</td><td>14,5</td><td>21,00</td></tr> <tr><td>G3/4</td><td>26,441</td><td>14</td><td>1,814</td><td>140</td><td>20</td><td>-</td><td>20,0</td><td>16,0</td><td>24,50</td></tr> <tr><td>G7/8</td><td>30,201</td><td>14</td><td>1,814</td><td>150</td><td>22</td><td>-</td><td>22,0</td><td>18,0</td><td>28,25</td></tr> <tr><td>G1</td><td>33,249</td><td>11</td><td>2,309</td><td>160</td><td>24</td><td>-</td><td>25,0</td><td>20,0</td><td>30,75</td></tr> </tbody> </table>										G	Ød ₁	1"/P	P	l ₁	l ₂	l ₃	Ød ₂	a		G1/16	7,723	28	0,907	90	10	-	6,0	4,9	6,80	G1/8	9,728	28	0,907	90	10	-	7,0	5,5	8,80	G1/4	13,157	19	1,337	100	14	-	11,0	9,0	11,80	G3/8	16,662	19	1,337	100	15	-	12,0	9,0	15,25	G1/2	20,955	14	1,814	125	17	-	16,0	12,0	19,00	G5/8	22,911	14	1,814	125	20	-	18,0	14,5	21,00	G3/4	26,441	14	1,814	140	20	-	20,0	16,0	24,50	G7/8	30,201	14	1,814	150	22	-	22,0	18,0	28,25	G1	33,249	11	2,309	160	24	-	25,0	20,0	30,75	Norma		DIN-5156					
										G	Ød ₁	1"/P	P	l ₁	l ₂	l ₃	Ød ₂	a																																																																																																			
G1/16	7,723	28	0,907	90	10	-	6,0	4,9	6,80																																																																																																												
G1/8	9,728	28	0,907	90	10	-	7,0	5,5	8,80																																																																																																												
G1/4	13,157	19	1,337	100	14	-	11,0	9,0	11,80																																																																																																												
G3/8	16,662	19	1,337	100	15	-	12,0	9,0	15,25																																																																																																												
G1/2	20,955	14	1,814	125	17	-	16,0	12,0	19,00																																																																																																												
G5/8	22,911	14	1,814	125	20	-	18,0	14,5	21,00																																																																																																												
G3/4	26,441	14	1,814	140	20	-	20,0	16,0	24,50																																																																																																												
G7/8	30,201	14	1,814	150	22	-	22,0	18,0	28,25																																																																																																												
G1	33,249	11	2,309	160	24	-	25,0	20,0	30,75																																																																																																												
										Tol.																																																																																																											
										INDEX		D4-118M01		D4-528M01																																																																																																							
										ISO		Vc (m/min)																																																																																																									
										P		10-40		10-40																																																																																																							
										M		5-15		5-15																																																																																																							
										K		10-30		10-30																																																																																																							
										N		10-50		10-50																																																																																																							
										S		1-8		1-8																																																																																																							

1

Whitworth pipe thread G, DIN-ISO 228

800X



HSSE

TN2

DIN 5156

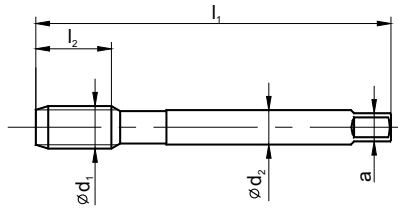

C-TN2 B-TN2 C-R40-TN2



Material groups



Hole type

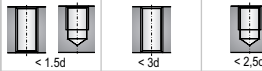

Quality of material

HSSE HSSE HSSE

Coating

TN2 TN2 TN2

Chamfer

C / 2-3P B / 4-5P C / 2-3P

G	Ød ₁	1"/P	P	l ₁	l ₂	l ₂ R40	Ød ₂	a		Norma			DIN-5156			
										Tol.						
										INDEX	D2-123X01	D2-113X01	D2-513X01			
G1/16	7,723	28	0,907	90	17	10	6,0	4,9	6,80	3121	○	○	○			
G1/8	9,728	28	0,907	90	18	10	7,0	5,5	8,80	3123	●	●	●			
G1/4	13,157	19	1,337	100	22	14	11,0	9,0	11,80	3127	●	●	●			
G3/8	16,662	19	1,337	100	22	15	12,0	9,0	15,25	3129	●	●	●			
G1/2	20,955	14	1,814	125	25	17	16,0	12,0	19,00	3131	●	●	●			
G5/8	22,911	14	1,814	125	25	20	18,0	14,5	21,00	3133	●	●	●			
G3/4	26,441	14	1,814	140	28	20	20,0	16,0	24,50	3135	●	●	●			
G7/8	30,201	14	1,814	150	30	22	22,0	18,0	28,25	3137	●	●	●			
G1	33,249	11	2,309	160	32	24	25,0	20,0	30,75	3139	●	●	●			
G1.1/8	37,907	11	2,309	170	34	24	28,0	22,0	35,50	3141	○	○	○			
G1.1/4	41,910	11	2,309	170	34	25	32,0	24,0	39,50	3143	○	○	○			
G1.1/2	47,800	11	2,309	190	36	-	36,0	29,0	45,25	3147	○	○	-			
G1.3/4	53,756	11	2,309	190	36	-	40,0	32,0	51,00	3151	○	○	-			
G2	59,614	11	2,309	220	40	-	45,0	35,0	57,00	3155	○	○	-			

ISO	Vc (m/min)		
P	5-35	5-35	5-20
M	5-15	5-15	5-15
K	5-25	10-25	5-15
N	10-30	10-30	5-25
S	-	-	-

800X



Whitworth pipe thread G, DIN-ISO 228											800								
 											C	B	C-R40						
Material groups											P M K	P M K	P M K						
Hole type																			
Quality of material											HSSE	HSSE	HSSE						
Coating																			
Chamfer											C / 2-3P	B / 4-5P	C / 2-3P						
											Norma			DIN-5156					
											Tol.								
											INDEX			D2-121101	D2-111101	D2-511101			
G	Ød ₁	1"/P	P	l ₁	l ₂	l ₂ R40	Ød ₂	a											
G1/16	7,723	28	0,907	90	17	10	6,0	4,9	6,80	3121	○	○	○						
G1/8	9,728	28	0,907	90	18	10	7,0	5,5	8,80	3123	●	●	●						
G1/4	13,157	19	1,337	100	22	14	11,0	9,0	11,80	3127	●	●	●						
G3/8	16,662	19	1,337	100	22	15	12,0	9,0	15,25	3129	●	●	●						
G1/2	20,955	14	1,814	125	25	17	16,0	12,0	19,00	3131	●	●	●						
G5/8	22,911	14	1,814	125	25	20	18,0	14,5	21,00	3133	●	●	●						
G3/4	26,441	14	1,814	140	28	20	20,0	16,0	24,50	3135	●	●	●						
G7/8	30,201	14	1,814	150	30	22	22,0	18,0	28,25	3137	●	●	●						
G1	33,249	11	2,309	160	32	24	25,0	20,0	30,75	3139	●	●	●						
G1.1/8	37,907	11	2,309	170	34	24	28,0	22,0	35,50	3141	○	○	○						
G1.1/4	41,910	11	2,309	170	34	25	32,0	24,0	39,50	3143	○	○	○						
G1.1/2	47,800	11	2,309	190	36	-	36,0	29,0	45,25	3147	○	○	-						
G1.3/4	53,756	11	2,309	190	36	-	40,0	32,0	51,00	3151	○	○	-						
G2	59,614	11	2,309	220	40	-	45,0	35,0	57,00	3155	○	○	-						
											ISO			Vc (m/min)					
											P	5-20	5-20	5-20					
											M	5-10	5-10	5-10					
											K	5-15	5-15	5-15					
											N	5-25	5-25	5-25					
											S	-	-	-					

1

Whitworth pipe thread G, DIN-ISO 228										<i>Ms</i>									
Material groups																			
Hole type										 < 1,5d									
Quality of material										HSSE									
Coating																			
Chamfer										F / 1P									
										Norma ~DIN-5157									
										Tol.									
										INDEX E2-141401									
G	Ød ₁	1"/P	P	l ₁	l ₂	Ød ₂	a												
G3/8	16,662	19	1,337	70	22	12	9	15,25		3129	●								
G1/2	20,965	14	1,814	80	22	16	12	19,00		3131	●								
G3/4	26,441	14	1,814	90	22	20	16	24,50		3135	●								
G1	33,259	11	2,309	100	25	25	20	30,75		3139	●								
										ISO Vc (m/min)									
										P									
										M									
										K									
										N									
										S									



Whitworth pipe thread G, DIN-ISO 228																				
Material groups																				
Hole type											 <small>< 1,5d</small>									
Quality of material											HSS									
Coating																				
Chamfer											~3P									
G	Ød ₁	1"/P	P	l ₁	l ₂	l ₃	Ød ₂	a		Norma										
										DIN-5157										
											Tol.									
											INDEX									
G1/16	7,723	28	0,907	56	22	-	6	4,9	6,80	3121	○									
G1/8	9,728	28	0,907	63	20	-	7	5,5	8,80	3123	○									
G1/4	13,157	19	1,337	70	22	-	11	9,0	11,80	3127	●									
G3/8	16,662	19	1,337	70	22	-	12	9,0	15,25	3129	●									
G1/2	20,955	14	1,814	80	22	-	16	12,0	19,00	3131	●									
G5/8	22,911	14	1,814	80	22	-	18	14,5	21,00	3133	○									
G3/4	26,441	14	1,814	90	22	-	20	16,0	24,50	3135	●									
G7/8	30,201	14	1,814	90	22	-	22	18,0	28,25	3137	○									
G1	33,249	11	2,309	100	25	-	25	20,0	30,75	3139	●									
G1.1/8	37,897	11	2,309	125	36	-	28	22,0	35,50	3141	○									
G1.1/4	41,910	11	2,309	125	36	-	32	24,0	39,50	3143	○									
G1.3/8	44,323	11	2,309	125	36	-	36	29,0	41,75	3145	○									
G1.1/2	47,803	11	2,309	140	40	-	36	29,0	45,25	3147	○									
G1.3/4	53,769	11	2,309	140	40	-	40	32,0	51,00	3151	○									
G2	59,614	11	2,309	160	40	-	45	35,0	57,00	3155	○									
											ISO	Vc (m/min)								
											P	5-20								
											M	-								
											K	-								
											N	-								
											S	-								

Whitworth pipe thread G, DIN-ISO 228

NGRf

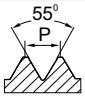

HSS

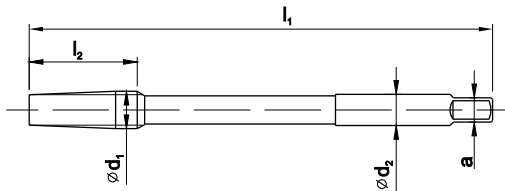

Material groups



Hole type



Quality of material

HSS

Coating











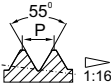
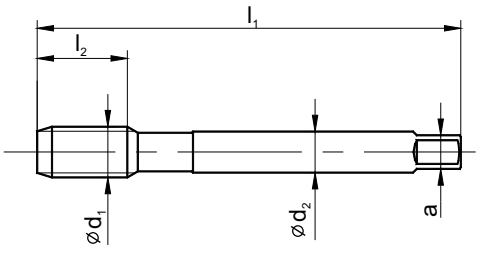

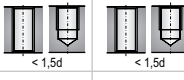
Chamfer









12P

G	Ød ₁	1"/P	P	l ₁	l ₂	l ₃	Ød ₂	a		Norma					
										NGRf					
										Tol.					
										INDEX	F1-151001				
G1/16	7,723	28	0,907	140	20	-	6,0	4,5	6,80	3121	o				
G1/8	9,728	28	0,907	140	20	-	7,0	6,3	8,80	3123	o				
G1/4	13,157	19	1,337	180	30	-	11,0	8,0	11,80	3127	o				
G3/8	16,662	19	1,337	200	30	-	12,0	10,0	15,25	3129	o				
G1/2	20,955	14	1,814	220	40	-	16,0	12,5	19,00	3131	●				
G5/8	22,911	14	1,814	220	40	-	18,0	14,0	21,00	3133	o				
G3/4	26,441	14	1,814	250	40	-	20,0	16,0	24,00	3135	o				
G7/8	30,201	14	1,814	280	40	-	22,0	18,0	28,25	3137	o				
G1	33,249	11	2,309	280	60	-	25,0	20,0	30,75	3139	o				
G1.1/8	37,907	11	2,309	280	60	-	28,0	22,4	35,50	3141	-				
G1.1/4	41,910	11	2,309	280	60	-	32,0	25,0	39,50	3143	o				
G1.3/8	44,323	11	2,309	280	60	-	32,0	25,0	42,00	3145	-				
G1.1/2	47,800	11	2,309	280	60	-	36,0	28,0	45,00	3147	o				
G1.3/4	53,756	11	2,309	280	60	-	40,0	28,0	51,00	3151	-				
G2	59,614	11	2,309	280	60	-	45,0	31,5	57,00	3155	o				

ISO	Vc (m/min)			
P	5-20			
M	-			
K	6-15			
N	6-15			
S	-			



Whitworth pipe thread Rp, PN-ISO 7/1, DIN EN 10226-1 											800					
Tapered whitworth pipe thread Rc, PN-ISO 7/1, DIN EN 10226-2 											c	c				
																
<div style="display: flex; flex-direction: column; gap: 5px;"> <div style="border: 1px solid black; padding: 2px; width: fit-content;">HSSE</div> <div style="border: 1px solid black; padding: 2px; width: fit-content;">DIN 5156</div> <div style="border: 1px solid black; padding: 2px; width: fit-content;">DIN ~5156</div> </div>											<div style="display: flex; gap: 5px;"> <div style="border: 1px solid black; padding: 2px; width: 15px; height: 15px; background-color: #e0e0e0;">P</div> <div style="border: 1px solid black; padding: 2px; width: 15px; height: 15px; background-color: #ffff00;">M</div> <div style="border: 1px solid black; padding: 2px; width: 15px; height: 15px; background-color: #ff0000;">K</div> <div style="border: 1px solid black; padding: 2px; width: 15px; height: 15px; background-color: #e0e0e0;">N</div> <div style="border: 1px solid black; padding: 2px; width: 15px; height: 15px; background-color: #e0e0e0;">S</div> <div style="border: 1px solid black; padding: 2px; width: 15px; height: 15px; background-color: #e0e0e0;">H</div> </div>					
Material groups											<div style="display: flex; gap: 5px;"> <div style="border: 1px solid black; padding: 2px; width: 15px; height: 15px; background-color: #e0e0e0;">P</div> <div style="border: 1px solid black; padding: 2px; width: 15px; height: 15px; background-color: #ffff00;">M</div> <div style="border: 1px solid black; padding: 2px; width: 15px; height: 15px; background-color: #ff0000;">K</div> <div style="border: 1px solid black; padding: 2px; width: 15px; height: 15px; background-color: #e0e0e0;">N</div> <div style="border: 1px solid black; padding: 2px; width: 15px; height: 15px; background-color: #e0e0e0;">S</div> <div style="border: 1px solid black; padding: 2px; width: 15px; height: 15px; background-color: #e0e0e0;">H</div> </div>					
Hole type																
Quality of material											HSSE	HSSE				
Coating																
Chamfer											C / 2-3P	C / 2-3P				
											Norma		DIN-5156			
											Tol.					
											INDEX		D2-121101			
Rp	Ød ₁	1"/P	P	l ₁	l ₂	l ₃	Ød ₂	a								
Rp-1/16"	7,723	28	0,907	90	17	-	6,0	4,9	6,55		3221	o				
Rp-1/8"	9,728	28	0,907	90	18	-	7,0	5,5	8,60		3223	o				
Rp-1/4"	13,157	19	1,337	100	22	-	11,0	9,0	11,50		3227	o				
Rp-3/8"	16,662	19	1,337	100	22	-	12,0	9,0	15,00		3229	o				
Rp-1/2"	20,955	14	1,814	125	25	-	16,0	12,0	18,50		3231	o				
Rp-3/4"	26,441	14	1,814	140	28	-	20,0	16,0	24,00		3235	o				
Rp-1"	33,249	11	2,309	160	32	-	25,0	20,0	30,25		3239	o				

											Norm		~DIN-5156			
											Tol.					
											INDEX		D2-121101			
Rc	Ød ₁	1"/P	P	l ₁	l ₂	l ₃	Ød ₂	a								
Rc-1/16"	-	28	0,907	90	15	-	6,0	4,9	6,15		3321	o				
Rc-1/8"	-	28	0,907	90	15	-	7,0	5,5	8,15		3323	●				
Rc-1/4"	-	19	1,337	100	19	-	11,0	9,0	10,85		3327	●				
Rc-3/8"	-	19	1,337	100	21	-	12,0	9,0	14,30		3329	●				
Rc-1/2"	-	14	1,814	125	26	-	16,0	12,0	17,80		3331	o				
Rc-3/4"	-	14	1,814	140	28	-	20,0	16,0	23,20		3335	o				
Rc-1"	-	11	2,309	160	33	-	25,0	20,0	29,20		3339	o				

ISO		Vc (m/min)			
P	5-20	5-20			
M	5-10	5-10			
K	5-15	5-15			
N	10-25	10-25			
S	-	-			

 Conical reamer 1:16 p. 174

 Information concerning dimensions of the holes for tapered threads in the technical part of the catalogue p. 335

● Available from stock
○ On request

1

American tapered pipe thread NPT 1:16, ANSI B-1.20.1

800

c

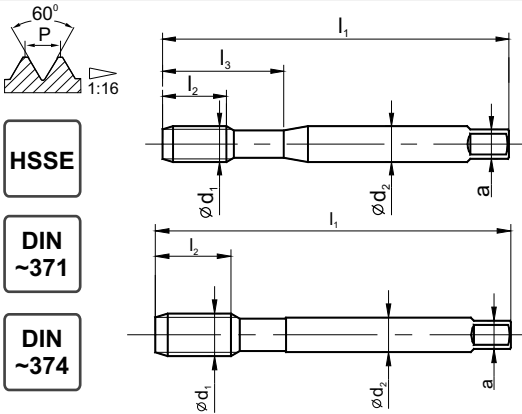

HSSE

DIN
~371

DIN
~374



Material groups



Hole type



Quality of material

HSSE

Coating

Chamfer

C / 2-3P

NPT	Ød ₁	1"/P	P	l ₁	l ₂	l ₃	Ød ₂	a		Norma					
										~DIN-371					
										Tol.					
										INDEX					
1/8	-	27	0,941	90	15	35	10,0	8,0	8,50	4623	●				
1/4	-	18	1,411	100	20	37,7	14,0	11,0	11,10	4627	●				

NPT	1"/P	P	l ₁	l ₂	l ₃	Ød ₂	a		Norm					
									~DIN-374					
									Tol.					
									INDEX					
3/8	18	1,411	110	22	-	14,0	11,0	14,40	4629	●				
1/2	14	1,814	140	27	-	18,0	14,5	17,80	4631	●				
3/4	14	1,814	140	28	-	20,0	16,0	23,15	4635	●				
1	11.1/2	2,209	160	35	-	25,0	20,0	29,05	4639	●				

ISO	V _c (m/min)			
P	5-20			
M	5-10			
K	5-15			
N	10-25			
S	-			



American tapered pipe thread NPTF 1:16, ANSI B-1.20.1										800											
HSSE DIN ~374																					
Material groups										<table border="1"> <tr><td>P</td><td>M</td><td>K</td></tr> <tr><td>N</td><td>S</td><td>H</td></tr> </table>		P	M	K	N	S	H				
P	M	K																			
N	S	H																			
Hole type																					
Quality of material										HSSE											
Coating																					
Chamfer										C / 2-3P											
									Norma	~DIN-374											
									Tol.												
									INDEX	D2-121101											
NPTF	Ød ₁	1"/P	P	l ₁	l ₂	Ød ₂	a														
1/8	-	27	0,941	90	15	7,0	5,5	8,45	4723	●											
1/4	-	18	1,411	100	20	11,0	9,0	10,90	4727	○											
3/8	-	18	1,411	110	22	14,0	11,0	14,30	4729	○											
1/2	-	14	1,814	140	27	18,0	14,5	17,60	4731	○											
										ISO Vc (m/min)											
										P	5-20										
										M	5-10										
										K	5-15										
										N	10-25										
										S	-										

1

American parallel pipe threads NPSF, ANSI B 1.20.3

800

c



HSSE

DIN ~374

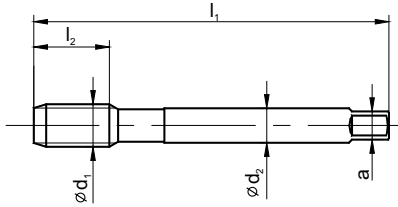

Material groups



Hole type



Quality of material

HSSE

Coating

Chamfer

C / 2-3P

NPSF	Ød ₁	1"/P	P	l ₁	l ₂	Ød ₂	a		Norma					
									~DIN-374					
									Tol.					
									INDEX	D2-121101				
1/16	7,582	27	0,941	90	20	6,0	4,9	6,35	4521	o				
1/8	9,929	27	0,941	90	20	7,0	5,5	8,70	4523	o				
1/4	13,236	18	1,411	100	20	11,0	9,0	11,30	4527	o				
3/8	16,673	18	1,411	100	20	12,0	9,0	14,75	4529	o				
1/2	20,814	14	1,814	125	27	16,0	12,0	18,20	4531	o				
3/4	26,166	14	1,814	140	27	20,0	16,0	23,50	4535	o				
1	32,718	11.1/2	2,209	160	32	25,0	20,0	29,50	4539	o				

ISO	Vc (m/min)				
P	5-20				
M	5-10				
K	5-15				
N	5-25				
S	-				



Whitworth thread BSW, BS-84:1956												800											
												B	C-R40										
HSSE DIN 371 DIN 376																							
Material groups												<table border="1"> <tr><td>P</td><td>M</td><td>K</td></tr> <tr><td>N</td><td>S</td><td>H</td></tr> </table>		P	M	K	N	S	H				
P	M	K																					
N	S	H																					
Hole type												<table border="1"> <tr><td></td><td></td></tr> <tr><td>< 3d</td><td>< 2.5d</td></tr> </table>				< 3d	< 2.5d						
< 3d	< 2.5d																						
Quality of material												HSSE											
Coating																							
Chamfer												B / 4-5P		C / 2-3P									
												Norma		DIN-371(~DIN2182)									
												Tol.		normal									
												INDEX		C2-111101									
BSW	Ød ₁	1"/P	P	l ₁	l ₂	l ₂ R40	l ₃	Ød ₂	a														
1/8-40	3,175	40	0,635	56	10	5	18	3,5	2,7	2,55	7123	o	o										
3/16-24	4,762	24	1,058	70	14	8	25	6,0	4,9	3,70	7125	o	o										
1/4-20	6,350	20	1,270	80	18	13	32	7,0	5,5	5,10	7127	o	o										
5/16-18	7,938	18	1,411	90	20	13	35	8,0	6,2	6,50	7128	o	o										
3/8-16	9,525	16	1,588	100	20	15	39	10,0	8,0	7,90	7129	o	o										
												Norm		DIN-376(~DIN2182)									
												Tol.											
												INDEX		D2-111101									
BSW	Ød ₁	1"/P	P	l ₁	l ₂	l ₂ R40	l ₃	Ød ₂	a														
7/16-14	11,112	14	1,814	100	22	15	-	8,0	6,2	9,25	7130	o	o										
1/2-12	12,700	12	2,117	110	24	18	-	9,0	7,0	10,50	7131	o	o										
5/8-11	15,875	11	2,309	110	32	22	-	12,0	9,0	13,50	7133	o	o										
3/4-10	19,050	10	2,540	125	32	25	-	14,0	11,0	16,40	7135	o	o										
7/8-9	22,225	9	2,822	140	32	30	-	18,0	14,5	19,25	7137	o	o										
1-8	25,400	8	3,175	160	38	30	-	20,0	16,0	22,00	7139	o	o										
												ISO		Vc (m/min)									
												P		5-20									
												M		5-10									
												K		5-15									
												N		5-25									
												S		-									

1

MASTER TAP

ISO Metric coarse thread DIN 8140-2

MASTER TAP

B-HL E-R45-HL

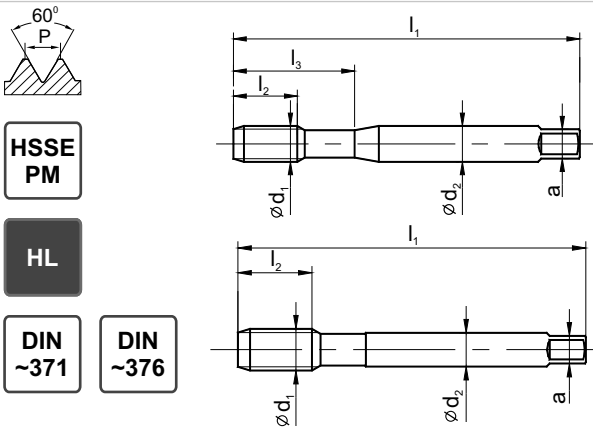

Material groups



Hole type



Quality of material

HSSE-PM HSSE-PM

Coating

HL HL

Chamfer

B / 4-5P E / 1,5-2P

EG M (STI)	Ød ₁	P	l ₁	l ₂	l ₃ R45	Ød ₂	a		Norma						
									~DIN-371 (DIN-40435)						
									Tol.	6H mod.	6H mod.				
									INDEX	C4-118M01	C4-718M01				
M2	2,520	0,40	50	9	5	14	2,8	2,1	2,10	6020	●	●			
M2,5	3,084	0,45	56	10	5	18	3,5	2,7	2,65	6025	●	●			
M3	3,650	0,50	63	12	5	21	4,5	3,4	3,15	6030	●	●			
M4	4,910	0,70	70	14	8	25	6,0	4,9	4,20	6040	●	●			
M5	6,040	0,80	80	18	10	30	6,0	4,9	5,25	6050	●	●			
M6	7,300	1,00	90	18	10	35	8,0	6,2	6,30	6060	●	●			
M8	9,624	1,25	100	20	13	39	10,0	8,0	8,40	6080	●	●			

EG M (STI)	Ød ₁	P	l ₁	l ₂	l ₃ R45	Ød ₂	a		Norm						
									~DIN-376 (DIN-40435)						
									Tol.	6H mod.	6H mod.				
									INDEX	D4-118M01	D4-718M01				
M10	11,948	1,50	100	15	15	-	9,0	7,0	10,50	6100	●	●			
M12	14,274	1,75	110	20	20	-	11,0	9,0	12,50	6120	●	●			
M14	16,598	2,00	110	20	20	-	12,0	9,0	14,50	6140	●	●			
M16	18,598	2,00	125	20	20	-	14,0	11,0	16,50	6160	●	●			
M18	21,248	2,50	140	27	27	-	18,0	14,5	18,75	6180	●	●			
M20	23,248	2,50	160	30	30	-	18,0	14,5	20,75	6200	●	●			

ISO	Vc (m/min)				
P	5-40	5-40			
M	5-15	5-15			
K	10-30	10-30			
N	10-30	10-30			
S	1-8	1-8			

American unified coarse thread UNC, ASME B18.29.1											MASTER TAP										
											B-HL		E-R45-HL								
<div style="display: flex; flex-direction: column; align-items: flex-start;"> <div style="border: 1px solid black; padding: 2px; margin-bottom: 5px;">HSSE PM</div> <div style="border: 1px solid black; padding: 2px; margin-bottom: 5px;">HL</div> <div style="display: flex; gap: 10px;"> <div style="border: 1px solid black; padding: 2px;">DIN ~371</div> <div style="border: 1px solid black; padding: 2px;">DIN ~376</div> </div> </div>											<div style="display: flex; gap: 5px;"> <div style="border: 1px solid black; padding: 1px;">P</div> <div style="border: 1px solid black; padding: 1px;">M</div> <div style="border: 1px solid black; padding: 1px;">K</div> </div>		<div style="display: flex; gap: 5px;"> <div style="border: 1px solid black; padding: 1px;">P</div> <div style="border: 1px solid black; padding: 1px;">M</div> <div style="border: 1px solid black; padding: 1px;">K</div> </div>								
Material groups											<div style="display: flex; gap: 5px;"> <div style="border: 1px solid black; padding: 1px;">N</div> <div style="border: 1px solid black; padding: 1px;">S</div> <div style="border: 1px solid black; padding: 1px;">H</div> </div>		<div style="display: flex; gap: 5px;"> <div style="border: 1px solid black; padding: 1px;">N</div> <div style="border: 1px solid black; padding: 1px;">S</div> <div style="border: 1px solid black; padding: 1px;">H</div> </div>								
Hole type																					
Quality of material											HSSE-PM		HSSE-PM								
Coating											HL		HL								
Chamfer											B / 4-5P		E / 1,5-2P								
EG UNC (STI)	Ød ₁	1/P	l ₁	l ₂	l ₂ R45	l ₃	Ød ₂	a		Norma	~DIN-371(DIN-40435)										
										Tol.	2B	2B									
										INDEX	C4-118M01	C4-718M01									
No4-40	3,671	40	63	13	7	21	4,5	3,4	3,10	6804	o	o									
No6-32	4,536	32	70	14	8	25	6,0	4,9	3,80	6806	o	o									
No8-32	5,197	32	80	16	10	30	6,0	4,9	4,40	6808	o	o									
No10-24	6,200	24	80	17	12	30	7,0	5,5	5,20	6810	o	o									
1/4-20	8,002	20	90	20	15	35	8,0	6,2	6,70	6827	o	o									
5/16-18	9,771	18	100	22	18	39	10,0	8,0	8,40	6828	o	o									
EG UNC (STI)	Ød ₁	1/P	l ₁	l ₂	l ₂ R45	l ₃	Ød ₂	a		Norm	~DIN-376(DIN-40435)										
										Tol.	2B	2B									
										INDEX	D4-118M01	D4-718M01									
3/8-16	11,587	16	100	15	15	-	9	7	10	6829	o	o									
7/16-14	13,469	14	110	18	18	-	11	9	11,6	6830	o	o									
1/2-13	15,237	13	110	18	18	-	12	9	13,3	6831	o	o									
9/16-12	17,039	12	110	20	20	-	12	9	14,9	6832	o	o									
5/8-11	18,875	11	125	20	20	-	14	11	16,5	6833	o	o									
3/4-10	22,349	10	140	25	25	-	18	14,5	19,75	6835	o	o									
ISO											Vc (m/min)										
P											5-40		5-40								
M											5-15		5-15								
K											10-30		10-30								
N											10-30		10-30								
S											1-8		1-8								

1

MASTER TAP

American unified fine thread UNF, ASME B18.29.1

MASTERTAP

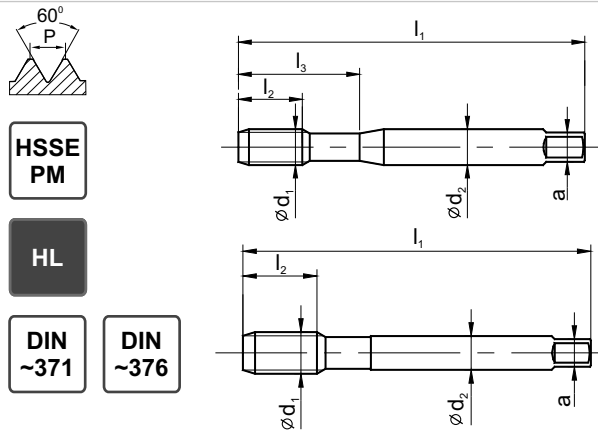

B-HL E-R45-HL



Material groups

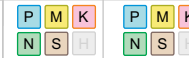

Hole type



Quality of material

HSSE-PM HSSE-PM

Coating

HL HL

Chamfer

B / 4-5P E / 1,5-2P

EG UNF (STI)	Ød ₁	1/P	l ₁	l ₂	l ₂ R45	l ₃	Ød ₂	a		Norma ~DIN-371(DIN-40435)		
										INDEX	2B	2B
										6904	o	o
No4-48	3,533	48	56	9	6	20	4	3	3	6904	o	o
No6-40	4,330	40	70	10	7	25	6	4,9	3,7	6906	o	o
No8-36	5,083	36	80	13	9	30	6	4,9	4,4	6908	o	o
No10-32	5,858	32	80	13	9	30	6	4,9	5,1	6910	o	o
1/4-28	7,528	28	90	17	10	35	8	6,2	6,6	6927	o	o
5/16-24	9,312	24	90	18	12	35	10	8	8,3	6928	o	o

EG UNF (STI)	Ød ₁	1/P	l ₁	l ₂	l ₂ R45	l ₃	Ød ₂	a		Norm ~DIN-376(DIN-40435)		
										INDEX	2B	2B
										6929	o	o
3/8-24	10,899	24	90	12	12	-	8	6	9,8	6929	o	o
7/16-20	12,763	20	100	15	15	-	9	7	11,5	6930	o	o
1/2-20	14,352	20	100	15	15	-	11	9	13,1	6931	o	o
9/16-18	16,121	18	100	15	15	-	12	9	14,7	6932	o	o
5/8-18	17,709	18	110	15	15	-	14	11	16,25	6933	o	o
3/4-16	21,112	16	125	17	17	-	16	12,0	19,5	6935	o	o

ISO	Vc (m/min)	
P	5-40	5-40
M	5-15	5-15
K	10-30	10-30
N	10-30	10-30
S	1-8	1-8



Trapezoidal thread Tr, DIN-103								NGSt					
 								LH					
Material groups													
Hole type													
Quality of material								HSS	HSS				
Coating								-	-				
Chamfer								24P	24P				
Tr Ød ₁	P	l ₁	l ₂	Ød ₂	a		Norma	NGSt					
							Tol.	7H	7H				
							INDEX	G1-701002	G1-751002				
Tr 10x1,5	1,5	100	45	7	5,5	8,5	8008	○	○				
Tr 10x2	2	115	76	7	5,5	8	8009	●	○				
Tr 12x2	2	120	74	8	6,3	10	8014	●	○				
Tr 12x3	3	155	104	8	6,3	9	8015	●	○				
Tr 14x2	2	130	74	10	8	12	8018	●	○				
Tr 14x3	3	160	104	10	8	11	8019	●	○				
Tr 16x2	2	135	74	11,2	9	14	8022	●	○				
Tr 16x4	4	200	132	11,2	9	12	8024	●	○				
Tr 18x2	2	140	74	12,5	10	16	8030	○	○				
Tr 18x4	4	205	132	12,5	10	14	8032	○	○				
Tr 20x2	2	145	74	14	11,2	18	8033	○	○				
Tr 20x4	4	210	132	14	11,2	16	8034	○	○				
Tr 22x3	3	185	104	16	12,5	19	8035	○	○				
Tr 22x5	5	250	165	16	12,5	17	8037	○	○				
Tr 24x3	3	190	104	18	14	21	8040	○	○				
Tr 24x5	5	255	165	18	14	19	8042	○	○				
Tr 26x3	3	195	104	20	16	23	8045	○	○				
Tr 26x5	5	265	165	20	16	21	8047	○	○				
Tr 28x3	3	205	104	22,4	18	25	8050	○	○				
Tr 28x5	5	270	165	22,4	18	23	8052	○	○				
Tr 30x3	3	205	104	22,4	18	27	8055	○	○				
Tr 30x6	6	305	206	22,4	18	24	8057	○	○				
Tr 32x6	6	315	206	25	20	26	8062	○	○				
Tr 36x6	6	325	206	28	22,4	30	8072	○	○				
ISO								Vc (m/min)					
P								2-6	2-6				
M								-	-				
K								2-6	2-6				
N								2-8	2-8				
S								-	-				



FORMING TAPS



SELECTION TABLE

4

CATALOGUE PAGES

93 - 97

M	DIN-371 DIN-376	Forming taps with strengthened shank Forming taps with transient shank	WGN	93
MF	DIN-371 DIN-374	Forming taps with strengthened shank Forming taps with transient shank	WGN	94
UNC	DIN-371 DIN-376	Forming taps with strengthened shank Forming taps with transient shank	WGN	95
UNF	DIN-371 DIN-374	Forming taps with strengthened shank Forming taps with transient shank	WGN	96
G	~DIN-5156	Forming taps with transient shank	WGN	97



ISO Metric coarse thread DIN-13										WGN									
										C-TN2	C-SR-TN2	C-SR-TN2	C-SR-TC	E-SR-TC	E-SR-IK-TC	E-SR-IKR-TC			
Material groups										P M K N S H	P M K N S H	P M K N S H	P M K N S H	P M K N S H	P M K N S H	P M K N S H			
Hole type																			
Quality of material										HSSE-PM	HSSE-PM	HSSE-PM	HSSE-PM	HSSE-PM	HSSE-PM	HSSE-PM			
Coating										TN2	TN2	TN2	TC	TC	TC	TC			
Chamfer										C / 2-3P	C / 2-3P	C / 2-3P	C / 2-3P	E / 1,5-2P	E / 1,5-2P	E / 1,5-2P			
M Ød ₁	P	l ₁	l ₂	l ₃	Ød ₂	a		DIN-371 (~DIN-2174)											
								Norm Tol.	6HX	6HX	6GX	6HX	6HX	6HX	6HX				
								INDEX	C4-903005	C4-923005	C4-923006	C4-925005	C4-945005	C4-945055	C4-945065				
M 1,6	0,35	40	8	8	2,5	2,1	1,47	0016	●	●	-	-	-	-	-				
M 2	0,40	45	8	8	2,8	2,1	1,85	0020	●	●	-	-	-	-	-				
M 2,5	0,45	50	9	9	2,8	2,1	2,33	0025	●	●	-	-	-	-	-				
M 3	0,50	56	10	18	3,5	2,7	2,80	0030	●	●	●	●	●	-	-				
M 3,5	0,60	56	12	20	4	3	3,25	0035	○	○	○	○	○	-	-				
M 4	0,70	63	7	21	4,5	3,4	3,70	0040	●	●	●	●	●	-	-				
M 5	0,80	70	8	25	6	4,9	4,65	0050	●	●	●	●	●	●	●				
M 6	1,00	80	10	30	6	4,9	5,60	0060	●	●	●	●	●	●	●				
M 7	1,00	80	10	30	7	5,5	6,60	0070	○	○	○	○	○	○	○				
M 8	1,25	90	13	35	8	6,2	7,45	0080	●	●	●	●	●	●	●				
M 9	1,25	90	13	35	9	7	8,45	0090	○	○	○	○	○	○	○				
M 10	1,50	100	15	39	10	8	9,35	0100	●	●	●	●	●	●	●				
M Ød ₁	P	l ₁	l ₂	l ₃	Ød ₂	a		DIN-376 (~DIN-2174)											
								Norm Tol.	6HX	6HX	6GX								
								INDEX	D4-903005	D4-923005	D4-923006								
M6	1	80	10	-	4,5	3,4	5,60	0060	●	●	●								
M8	1,25	90	13	-	6	4,9	7,45	0080	●	●	●								
M 10	1,5	100	15	-	7	5,5	9,35	0100	●	●	●								
M 12	1,75	110	18	-	9	7	11,25	0120	●	●	●								
M 14	2	110	20	-	11	9	13,10	0140	●	●	●								
M 16	2	110	20	-	12	9	15,10	0160	●	●	●								
M 18	2,5	125	25	-	14	11	16,85	0180	●	●	●								
M 20	2,5	140	25	-	16	12	18,85	0200	●	●	●								
ISO	Vc (m/min)																		
P	10-30	10-30	10-30	10-30	10-30	10-50	10-50												
M	10-25	10-25	10-25	10-25	10-25	10-25	10-25												
K	-	-	-	-	-	-	-												
N	20-40	20-40	20-40	20-60	20-60	20-60	20-60												
S	-	-	-	-	-	-	-												

2

ISO Metric fine thread DIN-13									WGN											
									C-SR-TN2	C-SR-TC										
<div style="display: flex; flex-direction: column; align-items: flex-start;"> <div style="border: 1px solid black; padding: 2px; margin-bottom: 5px;">HSSE PM</div> <div style="border: 1px solid black; padding: 2px; margin-bottom: 5px;">TN2</div> <div style="border: 1px solid black; padding: 2px; margin-bottom: 5px;">TC</div> <div style="display: flex; gap: 10px;"> <div style="border: 1px solid black; padding: 2px;">DIN 371</div> <div style="border: 1px solid black; padding: 2px;">DIN 374</div> </div> </div>																				
Material groups									<table border="1"> <tr><td>P</td><td>M</td><td>K</td></tr> <tr><td>N</td><td>S</td><td>H</td></tr> </table>		P	M	K	N	S	H				
P	M	K																		
N	S	H																		
Hole type																				
Quality of material									HSSE-PM											
Coating									TN2											
Chamfer									C / 2-3P											
MF Ød ₁	P	l ₁	l ₂	l ₃	Ød ₂	a		Norm												
								DIN-371 (~DIN-2174)												
								Tol.	6HX	6HX										
									INDEX		C4-923005	C4-925005								
M 4 x 0,5	0,5	63	7	21	4,5	3,4	3,80	0041	•	•										
M 5 x 0,5	0,5	70	8	25	6	4,9	4,80	0051	•	•										
M 6 x 0,5	0,5	80	10	30	6	4,9	5,80	0061	•	•										
M 6 x 0,75	0,75	80	10	30	7	5,5	5,70	0062	•	•										
M 8 x 1	1	90	13	35	8	6,2	7,60	0083	•	•										
M 10 x 1	1	90	13	35	10	8	9,60	0103	•	•										
M 10 x 1,25	1,25	100	15	39	10	8	9,45	0104	•	•										
MF Ød ₁	P	l ₁	l ₂	l ₃	Ød ₂	a		Norm												
								DIN-374 (~DIN-2174)												
								Tol.	6HX	6HX										
									INDEX		D4-923005	D4-925005								
M 6 x 0,5	0,5	80	10	-	4,5	3,4	5,80	0061	○	○										
M 6 x 0,75	0,75	80	10	-	4,5	3,4	5,70	0062	○	○										
M 8 x 1	1	90	10	-	6,0	4,9	7,60	0083	•	•										
M 10 x 1	1	90	10	-	7,0	5,5	9,60	0103	•	•										
M 10 x 1,25	1,25	100	15	-	7,0	5,5	9,45	0104	•	•										
M 12 x 1	1	100	10	-	9,0	7	11,60	0123	•	•										
M 12 x 1,25	1,25	100	15	-	9,0	7	11,45	0124	•	•										
M 12 x 1,5	1,5	100	15	-	9,0	7	11,35	0125	•	•										
M 16 x 1,5	1,5	100	15	-	12	9	15,35	0165	•	•										
M 18 x 1,5	1,5	110	17	-	14	11	17,35	0185	•	•										
M 20 x 1,5	1,5	125	17	-	16	12	19,35	0205	•	•										
ISO										V _c (m/min)										
P										10-30	10-30									
M										10-25	10-25									
K										-	-									
N										20-40	20-60									
S										-	-									



American unified coarse thread UNC, ANSI B-1.1											WGN										
											C-SR-TN2										
<div style="display: flex; flex-direction: column; align-items: center;"> <div style="border: 1px solid black; padding: 2px; margin-bottom: 5px;">HSSE</div> <div style="border: 1px solid black; padding: 2px; margin-bottom: 5px;">TN2</div> <div style="border: 1px solid black; padding: 2px; margin-bottom: 5px;">DIN 371</div> <div style="border: 1px solid black; padding: 2px;">DIN 376</div> </div>											<div style="display: flex; gap: 5px;"> P M K </div> <div style="display: flex; gap: 5px; margin-top: 5px;"> N S H </div>										
Material groups																					
Hole type											HSSE										
Quality of material											TN2										
Coating											C / 2-3P										
Chamfer											DIN-371 (~DIN-2174)										
UNC	Ød ₁	1"/P	P	l ₁	l ₂	l ₃	Ød ₂	a		Norm	Tol.	INDEX									
No 5-40	3,175	40	0,635	56	7	18	3,5	2,7		4105	o										
No 6-32	3,505	32	0,795	56	6	20	4,0	3,0		4106	o										
No 8-32	4,166	32	0,794	63	7	21	4,5	3,4		4108	o										
No 10-24	4,826	24	1,058	70	8	25	6,0	4,9		4110	o										
No 12-24	5,486	24	1,058	80	10	30	6,0	4,9		4112	o										
1/4-20	6,350	20	1,270	80	13	30	7,0	5,5		4127	o										
5/16-18	7,938	18	1,411	90	13	35	8,0	6,2		4128	o										
3/8-16	9,525	16	1,588	100	15	39	10	8,80		4129	o										
UNC	Ød ₁	1"/P	P	l ₁	l ₂	l ₃	Ød ₂	a		Norm	Tol.	INDEX									
										DIN-376 (~DIN-2174)	2BX										
												D2-923105									
7/16-14	11,112	14	1,814	100	15	-	8	6,2		4130	o										
1/2-13	12,700	13	1,954	110	18	-	9	7		4131	o										
5/8-11	15,875	11	2,309	110	20	-	12	9		4133	o										
											ISO		Vc (m/min)								
											P	10-30									
											M	10-25									
											K	-									
											N	20-40									
											S	-									

2

American unified fine thread UNF, ANSI B-1.1										WGN							
										C-SR-TN2							
<div style="display: flex; flex-direction: column; gap: 5px;"> <div style="border: 1px solid black; padding: 2px; width: fit-content;">HSSE</div> <div style="border: 1px solid black; padding: 2px; width: fit-content;">TN2</div> <div style="border: 1px solid black; padding: 2px; width: fit-content;">DIN 371</div> <div style="border: 1px solid black; padding: 2px; width: fit-content;">DIN 374</div> </div>										<div style="display: flex; gap: 5px;"> P M K </div>							
Material groups										<div style="display: flex; gap: 5px;"> N S H </div>							
Hole type																	
Quality of material										HSSE							
Coating										TN2							
Chamfer										C / 2-3P							
										Norm		DIN-371 (~DIN-2174)					
UNF	Ød ₁	1"/P	P	l ₁	l ₂	l ₃	Ød ₂	a		Tol.	2BX						
										INDEX		C2-923105					
No 5-44	3,175	44	0,577	56	7	18	3,5	2,7	2,92	4205	o						
No 6-40	3,505	40	0,635	56	6	20	4	3	3,22	4206	o						
No 8-36	4,166	36	0,706	63	7	21	4,5	3,4	3,85	4208	o						
No 10-32	4,826	32	0,794	70	8	25	6	4,9	4,45	4210	o						
No 12-28	5,486	28	0,907	80	10	30	6	4,9	5,10	4212	o						
1/4-28	6,350	28	0,907	80	10	30	6	4,9	5,95	4227	o						
5/16-24	7,938	24	1,058	90	13	35	8	6,2	7,45	4228	o						
3/8-24	9,525	24	1,058	90	15	35	10	8	9,05	4229	o						
										Norm		DIN-374 (~DIN-2174)					
UNF	Ød ₁	1"/P	P	l ₁	l ₂	Ød ₂	a		Tol.	2BX							
										INDEX		D2-923105					
7/16-20	11,112	20	1,270	100	15	8	6,2	10,55	4230	o							
1/2-20	12,700	20	1,270	110	15	9	7	12,15	4231	o							
5/8-18	15,875	18	1,411	110	15	12	9	15,25	4233	o							
3/4-16	19,050	16	1,588	120	17	14	11	18,35	4235	o							
										ISO		Vc (m/min)					
										P	10-30						
										M	10-25						
										K	-						
										N	20-40						
										S	-						

Whitworth pipe thread G, DIN-ISO 228										WGN								
 										C-SR-TN2								
Material groups																		
Hole type																		
Quality of material										HSSE								
Coating										TN2								
Chamfer										C / 2-3P								
										Norm ~DIN-5156								
										Tol.								
										INDEX D2-923105								
G	Ød ₁	1"/P	P	l ₁	l ₂	Ød ₂	a											
G-1/8"	9,728	28	0,907	90	10	7	5,5	9,25	3123	●								
G-1/4"	13,157	19	1,337	100	14	11	9	12,55	3127	●								
G-3/8"	16,662	19	1,337	100	15	12	9	16,05	3129	●								
G-1/2"	20,955	14	1,814	125	17	16	12	20,10	3131	●								
G-5/8"	22,911	14	1,814	125	20	18	14,5	22,05	3133	●								
G-3/4"	26,441	14	1,814	140	22	20	16	25,60	3135	●								
										ISO		Vc (m/min)						
										P		10-30						
										M		10-25						
										K		-						
										N		20-40						
										S		-						



THREAD MILLS



SELECTION TABLE

4

CATALOGUE PAGES

101 - 104

M MF	Thread mills		101
	Thread mills with chamfering part		102
	Thread mills with short cutting part for hardened materials	<i>HRC</i>	103
	Thread mills for small holes		104



Metric coarse thread ISO DIN-13										
								IK		
Material groups										
Quality of material								VHM	VHM	
Coating								TS	TS	
P	M	MF	Ød ₁	Ød ₂	l ₁	l ₂	z	INDEX	INDEX	
0,5	M3	Ø ≥ 4	2,3	6	58,0	5,3	4	MI-41G100M-0050	-	
0,5		Ø ≥ 5	3,9	6	58,0	10,3	4	MI-41G100M-0050A	MI-41G150M-0050A	
0,7	M4	Ø ≥ 5	3,1	6	58,0	7,1	4	MI-41G100M-0070	MI-41G150M-0070	
0,75		Ø ≥ 6	4,6	6	58,0	10,1	4	MI-41G100M-0075	MI-41G150M-0075	
0,8	M5	Ø ≥ 6	3,9	6	58,0	8,7	4	MI-41G100M-0080	MI-41G150M-0080	
1	M6	Ø ≥ 7	4,6	6	58,0	10,5	4	MI-41G100M-0100	MI-41G150M-0100	
1	M6	Ø ≥ 7	4,6	6	58,0	15,0	4	MI-41G100M-0100A	MI-41G150M-0100A	
1		Ø ≥ 9	6,0	6	58,0	12,5	4	MI-41G100M-0100B	MI-41G150M-0100B	
1		Ø ≥ 10	8,0	8	64,0	16,5	4	MI-41G100M-0100C	MI-41G150M-0100C	
1,25	M8	Ø ≥ 10	5,9	6	58,0	13,9	4	MI-41G100M-0125	MI-41G150M-0125	
1,25	M8	Ø ≥ 10	5,9	6	58,0	20,0	4	MI-41G100M-0125A	MI-41G150M-0125A	
1,5	M10	Ø ≥ 12	7,9	8	64,0	17,3	4	MI-41G100M-0150	MI-41G150M-0150	
1,5	M10	Ø ≥ 12	7,9	8	76,0	25,0	4	MI-41G100M-0150A	MI-41G150M-0150A	
1,5		Ø ≥ 14	10,0	10	73,0	21,8	4	MI-41G100M-0150B	MI-41G150M-0150B	
1,5		Ø ≥ 20	15,9	16	105,0	33,8	4	MI-41G100M-0150C	MI-41G150M-0150C	
1,75	M12	Ø ≥ 14	9,6	10	76,0	20,6	6	MI-61G100M-0175	MI-61G150M-0175	
1,75	M12	Ø ≥ 14	9,6	10	76,0	30,0	6	MI-61G100M-0175A	MI-61G150M-0175A	
2	M14/M16	Ø ≥ 17	11,4	12	73,0	27,0	6	MI-61G100M-0200	MI-61G150M-0200	
2	M14/M16	Ø ≥ 17	11,4	12	105,0	39,0	6	MI-61G100M-0200A	MI-61G150M-0200A	
2		Ø ≥ 20	15,9	16	105,0	35,0	6	MI-61G100M-0200B	MI-61G150M-0200B	
2,5	M18/M20	Ø ≥ 22	14,9	16	84,0	33,8	6	MI-61G100M-0250	MI-61G150M-0250	
2,5	M18/M20	Ø ≥ 22	14,9	16	105,0	50,0	6	MI-61G100M-0250A	MI-61G150M-0250A	

ISO			Vc [m/min]	Feed [mm/tooth]								
				Ø2	Ø3	Ø4	Ø6	Ø8	Ø10	Ø12	Ø14	Ø16
P	P1-P5	Constructional and carburizing steel	100-150	0,02	0,03	0,03	0,05	0,06	0,07	0,08	0,09	0,10
	P6-P9	Carbon steel, low-alloy steel, cast steel	85-120	0,015	0,02	0,025	0,03	0,04	0,05	0,06	0,07	0,08
	P10-P12	Alloy steel, Tool steel, Tempered steel up to 38 HRC	70-100	0,015	0,02	0,025	0,03	0,035	0,04	0,05	0,055	0,06
	P13-P14	Ferritic steel, martensitic steel	60-90	0,01	0,015	0,02	0,025	0,03	0,035	0,04	0,045	0,05
M	M1-M2	Austenitic steel	60-90	0,01	0,015	0,02	0,025	0,03	0,035	0,04	0,045	0,05
	M3	Duplex steel	50-70	0,01	0,015	0,02	0,025	0,03	0,035	0,04	0,045	0,05
K	K1-K5	Grey cast iron	70-150	0,015	0,02	0,025	0,03	0,04	0,05	0,06	0,07	0,08
N	N1-N10	Aluminium alloys 1% < Si < 7%, Pure copper, low-alloyed copper	150-220	0,03	0,04	0,04	0,06	0,07	0,08	0,09	0,11	0,12
		Aluminium alloys Si ≥ 7%	100-180	0,02	0,02	0,03	0,03	0,04	0,05	0,05	0,06	0,07
		Duroplasts and Thermoplastics	100-300	0,05	0,06	0,07	0,08	0,10	0,11	0,12	0,14	0,15

Metric coarse thread ISO DIN-13											
								IK			
Material groups											
Quality of material								VHM		VHM	
Coating								TS		TS	
P	M	MF	Ød ₁	Ød ₂	l ₁	l ₂	z	INDEX	INDEX		
0,5	M3	Ø ≥ 4	2,3	6	58,0	5,3	4	MI-41G1J0M-0050	-		
0,7	M4	Ø ≥ 5	3,1	6	58,0	7,1	4	MI-41G1J0M-0070	MI-41G1K0M-0070		
0,75		Ø ≥ 6	4,6	6	58,0	10,1	4	MI-41G1J0M-0075	MI-41G1K0M-0075		
0,8	M5	Ø ≥ 6	3,9	6	58,0	8,7	4	MI-41G1J0M-0080	MI-41G1K0M-0080		
1	M6	Ø ≥ 7	4,6	8	58,0	10,5	4	MI-41G1J0M-0100	MI-41G1K0M-0100		
1	M6	Ø ≥ 7	4,6	8	58,0	15,0	4	MI-41G1J0M-0100A	MI-41G1K0M-0100A		
1,25	M8	Ø ≥ 10	5,9	10	58,0	13,9	4	MI-41G1J0M-0125	MI-41G1K0M-0125		
1,25	M8	Ø ≥ 10	5,9	10	58,0	20,0	4	MI-41G1J0M-0125A	MI-41G1K0M-0125A		
1,5	M10	Ø ≥ 12	7,9	12	64,0	17,3	4	MI-41G1J0M-0150	MI-41G1K0M-0150		
1,5	M10	Ø ≥ 12	7,9	12	76,0	25,0	4	MI-41G1J0M-0150A	MI-41G1K0M-0150A		
1,75	M12	Ø ≥ 14	9,6	14	76,0	20,6	6	MI-61G1J0M-0175	MI-61G1K0M-0175		
1,75	M12	Ø ≥ 14	9,6	14	76,0	30,0	6	MI-61G1J0M-0175A	MI-61G1K0M-0175A		
2	M14		11,4	16	73,0	27,0	6	MI-61G1J0M-0200	MI-61G1K0M-0200		
2	M16	Ø ≥ 17	13,4	18	105,0	39,0	6	MI-61G1J0M-0200A	MI-61G1K0M-0200A		

ISO			Vc [m/min]	Feed [mm/tooth]								
				Ø2	Ø3	Ø4	Ø6	Ø8	Ø10	Ø12	Ø14	Ø16
P	P1-P5	Constructional and carburizing steel	100-150	0,02	0,03	0,03	0,05	0,06	0,07	0,08	0,09	0,10
	P6-P9	Carbon steel, low-alloy steel, cast steel	85-120	0,015	0,02	0,025	0,03	0,04	0,05	0,06	0,07	0,08
	P10-P12	Alloy steel, Tool steel, Tempered steel up to 38 HRC	70-100	0,015	0,02	0,025	0,03	0,035	0,04	0,05	0,055	0,06
	P13-P14	Ferritic steel, martensitic steel	60-90	0,01	0,015	0,02	0,025	0,03	0,035	0,04	0,045	0,05
M	M1-M2	Austenitic steel	60-90	0,01	0,015	0,02	0,025	0,03	0,035	0,04	0,045	0,05
	M3	Duplex steel	50-70	0,01	0,015	0,02	0,025	0,03	0,035	0,04	0,045	0,05
K	K1-K5	Grey cast iron	70-150	0,015	0,02	0,025	0,03	0,04	0,05	0,06	0,07	0,08
N	N1-N10	Aluminium alloys 1% < Si < 7%, Pure copper, low-alloyed copper	150-220	0,03	0,04	0,04	0,06	0,07	0,08	0,09	0,11	0,12
		Aluminium alloys Si ≥ 7%	100-180	0,02	0,02	0,03	0,03	0,04	0,05	0,05	0,06	0,07
		Duroplasts and Thermoplastics	100-300	0,05	0,06	0,07	0,08	0,10	0,11	0,12	0,14	0,15

Metric coarse thread ISO DIN-13							HRC			
 							 M04 - left hand cutting			
Material groups										
Quality of material							VHM			
Coating							TS			
P	M	$\varnothing d_1$	$\varnothing d_2$	l_1	l_2	z	INDEX			
0,5	M3	2,3	6	58	6,5	4	MI-40G9A2M-0050			
		2,3	6	58	9,5	4	MI-40G9A2M-0050A			
0,7	M4	3,1	6	58	9,0	4	MI-40G9A2M-0070			
		3,1	6	58	12,5	4	MI-40G9A2M-0070A			
0,8	M5	3,9	6	58	12,5	4	MI-40G9A2M-0080			
		3,9	6	58	16,0	4	MI-40G9A2M-0080A			
1	M6	4,6	6	58	14,0	4	MI-40G9A2M-0100			
		4,6	6	58	20,0	4	MI-40G9A2M-0100A			
1,25	M8	5,9	6	58	18,0	4	MI-40G9A2M-0125			
		5,9	6	58	24,0	4	MI-40G9A2M-0125A			
1,5	M10	7,9	8	64	23,0	4	MI-40G9A2M-0150			
		7,9	8	64	32,2	4	MI-40G9A2M-0150A			
1,75	M12	9,6	10	73	26,0	6	MI-60G9A2M-0175			
		9,6	10	73	36,4	6	MI-60G9A2M-0175A			
2	M16	11,4	12	84	35,0	6	MI-60G9A2M-0200			
		11,4	12	84	49,0	6	MI-60G9A2M-0200A			



ISO			Vc [m/min]	Feed [mm/tooth]						
				$\varnothing 2$	$\varnothing 3$	$\varnothing 4$	$\varnothing 6$	$\varnothing 8$	$\varnothing 10$	$\varnothing 12$
P	P10-P12	Alloy steel, Tool steel, Tempered steel up to 38 HRC	70-100	0,02	0,03	0,04	0,05	0,06	0,07	0,08
	P13-P14	Ferritic steel, martensitic steel	60-90	0,02	0,03	0,03	0,04	0,05	0,06	0,06
M	M1-M2	Austenitic steel	60-90	0,02	0,03	0,03	0,04	0,05	0,06	0,06
	M3	Duplex steel	50-70	0,02	0,02	0,03	0,03	0,04	0,05	0,05
S	S1-S5	Nickel and its alloys	20-40	0,01	0,01	0,015	0,02	0,03	0,04	0,05
	S6-S8	Titanium and its alloys	30-50	0,01	0,01	0,015	0,02	0,03	0,04	0,05
H	H1	45-50HRC	55-70	0,015	0,02	0,03	0,04	0,05	0,06	0,07
	H2	50-55HRC	40-60	0,01	0,015	0,02	0,025	0,03	0,04	0,05
	H3	55-60HRC	35-50	0,01	0,01	0,015	0,02	0,025	0,035	0,04

3

Universal thread mill for internal, external, left and right hand threads

VHM

AT

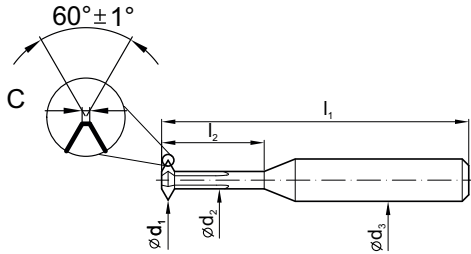

Material groups



Quality of material

VHM

Coating

AT

Thread profile angle

60°

Thread	d ₁	d ₂	d ₃	l ₁	l _{2 min}	C	INDEX
M1	0,71	0,39	3,0	39	3	0,015	MI-84V002-0100U
M2	1,50	0,99	3,0	39	6	0,020	MI-84V002-0200U
M3	2,30	1,62	6,0	66	9	0,030	MI-84V002-0300U
M4	3,10	2,19	6,0	66	12	0,040	MI-84V002-0400U
M5	4,00	2,98	6,0	66	15	0,050	MI-84V002-0500U
M6	4,80	3,55	6,0	75	18	0,070	MI-84V002-0600U
M8	6,50	4,96	8,0	80	22	0,080	MI-84V002-0800U
M10	7,90	6,07	8,0	80	26	0,090	MI-84V002-1000U

	Vc (m/min)	Feed [mm/tooth]					
		Ø1-Ø2	Ø3-Ø4	Ø6-Ø8	Ø10-Ø12	Ø16	
P	Rm<500	70-90	0,010	0,012	0,015	0,020	0,030
	Rm<800	50-80	0,010	0,012	0,015	0,020	0,030
	Rm<1000	45-60	0,010	0,012	0,013	0,017	0,025
	Rm<1400	40-55	0,010	0,012	0,013	0,017	0,025
M		35-50	0,007	0,010	0,010	0,015	0,020
K		40-60	0,010	0,012	0,013	0,017	0,025
N		60-180	0,012	0,012	0,015	0,020	0,030
S		25-40	0,007	0,010	0,010	0,015	0,020

Practical example

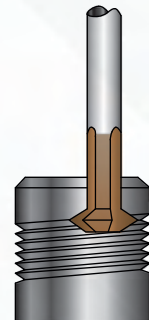
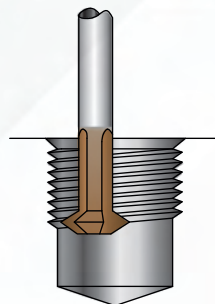
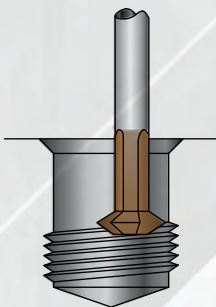

HAND TAPS

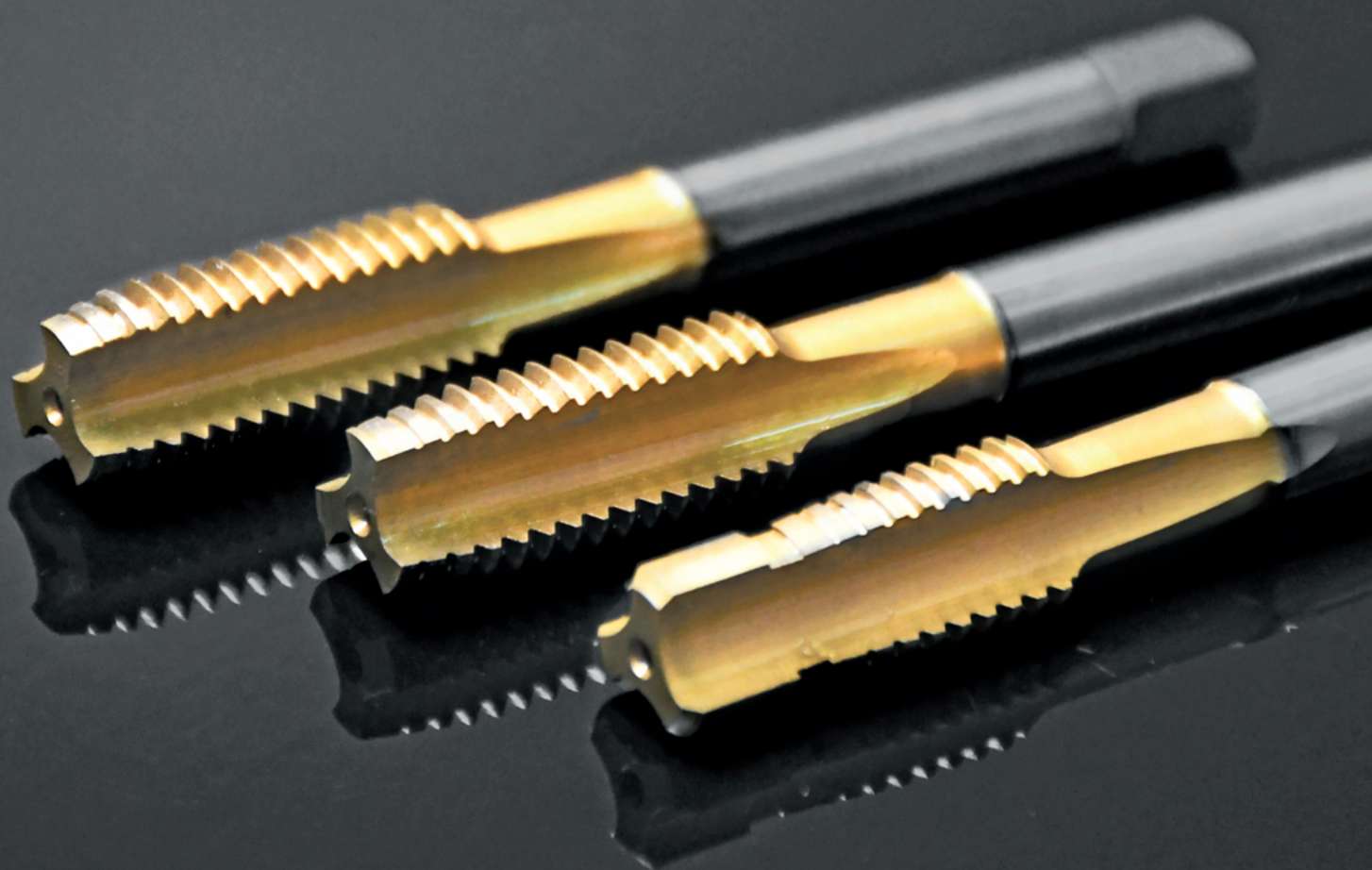

SELECTION TABLE

5

CATALOGUE PAGES

107 - 123

M	DIN-352	Set of hand taps three pieces Set of hand taps two pieces Finish hand taps F		107 - 109
	DIN-352	Set of hand taps three pieces Finish hand taps F	INOX	110 - 111
	~DIN-352	Set of hand taps three pieces Finish hand taps F	HRC40	112
MF	DIN-2181	Set of hand taps three pieces Finish hand taps F		113 - 115
	DIN-2181	Set of hand taps two pieces Finish hand taps F	HRC40	116
UNC	DIN-352	Set of hand taps three pieces Finish hand taps F		117
UNF	DIN-2181	Set of hand taps two pieces Finish hand taps F		118
G	DIN-5157	Set of hand taps two pieces for pipe thread Finish hand taps F		119
	DIN-5157	Set of hand taps two pieces for pipe thread Finish hand taps F	INOX	120
	DIN-5157	Set of hand taps two pieces for pipe thread Finish hand taps F	HRC40	121
BSW	DIN-352	Set of hand taps three pieces Finish hand taps F		122
BSF	DIN-2181	Set of hand taps three pieces Finish hand taps F		123

ISO Metric coarse thread DIN-13									KPL/3			KPL/2		F
HSS DIN 352									$\leq M10$			$\leq M10$		$\leq M10$
$\leq M10$									$> M10$			$> M10$		$> M10$
Material groups														
Hole type														
Quality of material									HSS			HSS		HSS
Coating														
Chamfer														~3P
M	P	l ₁	l ₂	l ₃	Ød ₂	a		Norm	DIN-352					
									ISO1 (4H)					
Ød ₁								INDEX	A1-230002	A1-220002	E1-131002			
M1	0,25	32,5	6,5	10,5	2,5	2,10	0,75	0010	○	-	-			
M1,1	0,25	32,5	6,5	10,5	2,5	2,10	0,85	0011	○	-	-			
M1,2	0,25	32,5	6,5	10,5	2,5	2,10	0,95	0012	○	-	-			
M1,4	0,30	32,5	8,0	10,5	2,5	2,10	1,10	0014	○	-	-			
									Tol.					
									ISO2 (6H)					
									INDEX	A1-230001	A1-220001	E1-131001		
M1,6	0,35	41,0	9,0	10,5	2,5	2,10	1,25	0016	●	-	●			
M1,7	0,35	41,0	9,0	10,5	2,5	2,10	1,35	0017	●	-	●			
M1,8	0,35	41,0	9,0	10,5	2,5	2,10	1,45	0018	●	-	●			
M2	0,40	36,0	10,0	10,0	2,8	2,10	1,60	0020	●	-	●			
M2,2	0,45	36,0	9,0	13,0	2,8	2,10	1,75	0022	●	-	●			
M2,3	0,40	36,0	9,0	13,0	2,8	2,10	1,90	0023	●	-	●			
M2,5	0,45	40,0	9,0	15,0	2,8	2,10	2,05	0025	●	-	●			
M2,6	0,45	40,0	9,0	15,0	2,8	2,10	2,15	0026	●	-	●			
M3	0,50	40,0	11,0	18,0	3,5	2,70	2,50	0030	●	●	●			
M3,5	0,60	45,0	13,0	21,0	4,0	3,00	2,90	0035	●	●	●			
M4	0,70	45,0	13,0	21,0	4,5	3,40	3,30	0040	●	●	●			
M4,5	0,75	50,0	16,0	25,0	6,0	4,90	3,70	0045	●	●	●			
M5	0,80	52,0	16,0	26,0	6,0	4,90	4,20	0050	●	●	●			
M6	1,00	56,0	18,0	27,0	6,0	4,90	5,00	0060	●	●	●			
M7	1,00	56,0	18,0	-	6,0	4,90	6,00	0070	●	●	●			
M8	1,25	63,0	20,0	-	6,0	4,90	6,80	0080	●	●	●			
M9	1,25	63,0	20,0	-	7,0	5,50	7,80	0090	●	●	●			
M10	1,50	70,0	22,0	-	7,0	5,50	8,50	0100	●	●	●			
M11	1,50	70,0	22,0	-	8,0	6,20	9,50	0110	●	●	●			
M12	1,75	80,0	24,0	-	9,0	7,00	10,20	0120	●	●	●			
M14	2,00	80,0	26,0	-	11,0	9,00	12,00	0140	●	●	●			
M16	2,00	80,0	27,0	-	12,0	9,00	14,00	0160	●	●	●			
M18	2,50	95,0	30,0	-	14,0	11,00	15,50	0180	●	●	●			
M20	2,50	95,0	32,0	-	16,0	12,00	17,50	0200	●	●	●			
M22	2,50	100,0	32,0	-	18,0	14,50	19,50	0220	●	●	●			
M24	3,00	110,0	34,0	-	18,0	14,50	21,00	0240	●	○	●			
M27	3,00	110,0	36,0	-	20,0	16,00	24,00	0270	●	○	●			

4

ISO Metric coarse thread DIN-13														
 									KPL/3	KPL/2	F			
									 Nr1 Nr2 F			 Nr1 F		 F
Material groups														
Hole type									 < 2,5d	 < 2,5d	 < 2,5d			
Quality of material									HSS	HSS	HSS			
Coating														
Chamfer											~3P			
M Ød ₁	P	l ₁	l ₂	l ₃	Ød ₂	a		Norm	DIN-352					
								Tol.	ISO2 (6H)	ISO2 (6H)	ISO2 (6H)			
								INDEX	A1-230001	A1-220001	E1-131001			
M30	3,5	125	40	-	22	18	26,5	0300	●	-	●			
M33	3,5	125	40	-	25	20	29,5	0330	●	-	●			
M36	4,0	150	50	-	28	22	32,0	0360	●	-	●			
M39	4,0	150	50	-	32	24	35,0	0390	●	-	●			
M42	4,5	150	56	-	32	24	37,5	0420	●	-	●			
M45	4,5	160	58	-	36	29	40,5	0450	●	-	●			
M48	5,0	180	65	-	36	29	43,0	0480	●	-	●			
M52	5,0	180	65	-	40	32	47,0	0520	●	-	●			
M56	5,5	200	75	-	45	35	50,5	0560	○	-	○			
M60	5,5	200	70	-	45	35	54,5	0600	○	-	○			
M64	6,0	220	75	-	50	39	58,0	0640	○	-	○			
M68	6,0	220	75	-	50	39	62,0	0680	○	-	○			

ISO Metric coarse thread DIN-13											
									KPL/3-LH	KPL/2-LH	F-LH
HSS DIN 352									≤ M10 > M10		
Material groups											
Hole type											
Quality of material									HSS		
Coating											
Chamfer									~3P		
M Ød ₁	P	l ₁	l ₂	l ₃	Ød ₂	a		Norm	DIN-352		
								Tol.	ISO2 (6H)	ISO2 (6H)	ISO2 (6H)
								INDEX	A1-270001	A1-260001	E1-231001
M3	0,50	40	11	18	3,5	2,7	2,5	0030	●	●	●
M3,5	0,60	45	13	21	4,0	3,0	2,9	0035	○	○	○
M4	0,70	45	13	21	4,5	3,4	3,3	0040	●	●	●
M4,5	0,75	50	16	25	6,0	4,9	3,7	0045	○	○	○
M5	0,80	52	16	26	6,0	4,9	4,2	0050	●	●	●
M6	1,00	56	18	27	6,0	4,9	5,0	0060	●	●	●
M7	1,00	56	18	-	6,0	4,9	6,0	0070	○	○	○
M8	1,25	63	20	-	6,0	4,9	6,8	0080	●	●	●
M9	1,25	63	20	-	7,0	5,5	7,8	0090	○	○	○
M10	1,50	70	22	-	7,0	5,5	8,5	0100	●	●	●
M11	1,50	70	22	-	8,0	6,2	9,5	0110	○	○	○
M12	1,75	80	24	-	9,0	7,0	10,2	0120	●	●	●
M14	2,00	80	26	-	11,0	9,0	12,0	0140	○	○	○
M16	2,00	80	27	-	12,0	9,0	14,0	0160	●	●	●
M18	2,50	95	30	-	14,0	11,0	15,5	0180	○	○	○
M20	2,50	95	32	-	16,0	12,0	17,5	0200	●	●	●
M22	2,50	100	32	-	18,0	14,5	19,5	0220	○	○	○
M24	3,00	110	34	-	18,0	14,5	21,0	0240	○	○	○
M27	3,00	110	36	-	20,0	16,0	24,0	0270	○	○	○
M30	3,50	125	40	-	22,0	18,0	26,5	0300	○	○	○
M33	3,50	125	40	-	25,0	20,0	29,5	0330	○	○	○
M36	4,00	150	50	-	28,0	22,0	32,0	0360	○	○	○
M39	4,00	150	50	-	32,0	24,0	35,0	0390	○	○	○
M42	4,50	150	56	-	32,0	24,0	37,5	0420	○	○	○
M45	4,50	160	58	-	36,0	29,0	40,5	0450	○	○	○
M48	5,00	180	65	-	36,0	29,0	43,0	0480	○	○	○
M52	5,00	180	65	-	40,0	32,0	47,0	0520	○	○	○
M56	5,50	200	75	-	40,0	32,0	50,5	0560	○	○	○
M60	5,50	200	70	-	45,0	35,0	54,5	0600	○	○	○
M64	6,00	220	75	-	50,0	39,0	58,0	0640	○	○	○
M68	6,00	220	75	-	50,0	39,0	62,0	0680	○	○	○



4

ISO Metric coarse thread DIN-13									INOX																	
									KPL/3-P		F															
Material groups									<table border="1"> <tr><td>P</td><td>M</td><td>K</td></tr> <tr><td>N</td><td>S</td><td>H</td></tr> </table>		P	M	K	N	S	H	<table border="1"> <tr><td>P</td><td>M</td><td>K</td></tr> <tr><td>N</td><td>S</td><td>H</td></tr> </table>		P	M	K	N	S	H		
P	M	K																								
N	S	H																								
P	M	K																								
N	S	H																								
Hole type																										
Quality of material									HSSE		HSSE															
Coating																										
Chamfer											~3P															
M Ød ₁	P	l ₁	l ₂	l ₃	Ød ₂	a		Norm	DIN-352																	
								Tol.	6HX	6HX																
								INDEX	A2-235801	A2-203801																
M2	0,40	36	10	10	2,8	2,1	1,6	0020	●	●																
M2,5	0,45	40	10	10	2,8	2,1	2,05	0025	●	●																
M3	0,50	40	10	18	3,5	2,7	2,5	0030	●	●																
M3,5	0,60	45	11	20	4,0	3,0	2,9	0035	○	○																
M4	0,70	45	12	21	4,5	3,4	3,3	0040	●	●																
M4,5	0,75	50	13	24	6,0	4,9	3,7	0045	○	○																
M5	0,80	52	14	25	6,0	4,9	4,2	0050	●	●																
M6	1,00	56	16	27	6,0	4,9	5,0	0060	●	●																
M8	1,25	63	22	-	6,0	4,9	6,8	0080	●	●																
M10	1,50	70	22	-	7,0	5,5	8,5	0100	●	●																
M12	1,75	80	24	-	9,0	7,0	10,2	0120	●	●																
M14	2,00	80	32	-	11,0	9,0	12,0	0140	●	●																
M16	2,00	80	32	-	12,0	9,0	14,0	0160	●	●																
M18	2,50	95	40	-	14,0	11,0	15,5	0180	●	●																
M20	2,50	95	40	-	16,0	12,0	17,5	0200	●	●																
M22	2,50	100	40	-	18,0	14,5	19,5	0220	●	●																
M24	3,00	110	50	-	18,0	14,5	21,0	0240	●	●																

ISO Metric coarse thread DIN-13									INOX			
									KPL/3-P	F		
<div style="display: flex; justify-content: space-between;"> <div style="border: 1px solid black; padding: 2px; width: 40px; text-align: center;">HSSE</div> <div style="border: 1px solid black; padding: 2px; width: 40px; text-align: center;">TN2</div> <div style="border: 1px solid black; padding: 2px; width: 40px; text-align: center;">DIN 352</div> </div>												
Material groups												
Hole type												
Quality of material									HSSE	HSSE		
Coating									TN2	TN2		
Chamfer										~3P		
M Ød ₁	P	l ₁	l ₂	l ₃	Ød ₂	a		Norm	DIN-352			
								Tol.	6HX	6HX		
								INDEX	A2-235831	A2-203831		
M2	0,40	36	10	10	2,8	2,1	1,6	0020	●	●		
M2,5	0,45	40	10	10	2,8	2,1	2,05	0025	●	●		
M3	0,50	40	10	18	3,5	2,7	2,5	0030	●	●		
M3,5	0,60	45	11	20	4,0	3,0	2,9	0035	○	○		
M4	0,70	45	12	21	4,5	3,4	3,3	0040	●	●		
M4,5	0,75	50	13	24	6,0	4,9	3,7	0045	○	○		
M5	0,80	52	14	25	6,0	4,9	4,2	0050	●	●		
M6	1,00	56	16	27	6,0	4,9	5,0	0060	●	●		
M8	1,25	63	22	-	6,0	4,9	6,8	0080	●	●		
M10	1,50	70	22	-	7,0	5,5	8,5	0100	●	●		
M12	1,75	80	24	-	9,0	7,0	10,2	0120	●	●		
M14	2,00	80	32	-	11,0	9,0	12,0	0140	●	●		
M16	2,00	80	32	-	12,0	9,0	14,0	0160	●	●		
M18	2,50	95	40	-	14,0	11,0	15,5	0180	●	●		
M20	2,50	95	40	-	16,0	12,0	17,5	0200	●	●		
M22	2,50	100	40	-	18,0	14,5	19,5	0220	●	●		
M24	3,00	110	50	-	18,0	14,5	21,0	0240	●	●		



4

ISO Metric coarse thread DIN-13									HRC40																	
									KPL/3-P		F															
Material groups									<table border="1"> <tr><td>P</td><td>M</td><td>K</td></tr> <tr><td>N</td><td>S</td><td>H</td></tr> </table>		P	M	K	N	S	H	<table border="1"> <tr><td>P</td><td>M</td><td>K</td></tr> <tr><td>N</td><td>S</td><td>H</td></tr> </table>		P	M	K	N	S	H		
P	M	K																								
N	S	H																								
P	M	K																								
N	S	H																								
Hole type																										
Quality of material									HSSE-PM		HSSE-PM															
Coating									TS		TS															
Chamfer											~3P															
M Ød ₁	P	l ₁	l ₂	l ₃	Ød ₂	a		Norm	~DIN-352																	
								Tol.	6HX	6HX																
								INDEX	A4-235D51	A4-203D51																
M3	0,50	40	10	-	3,5	2,7	2,5	0030	●	●																
M4	0,70	50	13	-	6,0	4,9	3,3	0040	●	●																
M5	0,80	50	16	-	6,0	4,9	4,2	0050	●	●																
M6	1,00	56	19	-	6,0	4,9	5,0	0060	●	●																
M8	1,25	63	22	-	6,0	4,9	6,8	0080	●	●																
M10	1,50	70	25	-	7,0	5,5	8,5	0100	●	●																
M12	1,75	80	30	-	9,0	7,0	10,2	0120	●	●																
M16	2,00	80	32	-	12,0	9,0	14,0	0160	●	●																
M20	2,50	95	40	-	16,0	12,0	17,5	0200	○	○																



Taps set HRC40 suitable for hardened steels up to 40HRC

Instruction of proper use HRC40 taps:

1. Maximum threading depth 1,5xD
2. Rigorously respect sequence of tapping procedure for hand taps sets using tap numbers in correct order
3. Please use only high quality cutting fluids (for example TEREBOR distributed by FANAR)
4. Carefully clear each tap from chips before next usage
5. Do not reverse the tap revolution before reach full depth of cut)

Taps F suitable for thread shape correction after hardening processor material galvanizing operations

Instruction of proper use F taps:

1. Please clean the threaded hole from mechanical impurities
2. Moistern bothe the tap and the hole with good quality tapping fluid (for example CIMTAP, TEREBOR or machine oil)
3. Enter tap into a hole by hand and make thread correction
4. Carefully clear each tap from chips before next usage

ISO Metric fine thread DIN-13																
									KPL/2	F	KPL/2-LH	F-LH				
Material groups																
Hole type																
Quality of material									HSS		HSS		HSS			
Coating																
Chamfer									~3P		~3P					
MF Ød ₁	P	l ₁	l ₂	l ₃	Ød ₂	a		Norm	DIN-2181							
								Tol.	ISO2 (6H)	ISO2 (6H)	ISO2 (6H)	ISO2 (6H)				
								INDEX	A1-220001	E1-131001	A1-260001	E1-231001				
M4x0,5	0,50	45	10	18,0	4,5	3,4	3,5	0041	●	●	○	○				
M4,5x0,5	0,50	50	12	22,0	6,0	4,9	4,0	0046	○	○	○	○				
M5x0,5	0,50	52	13	22,0	6,0	4,9	4,5	0051	●	●	○	○				
M5,5x0,5	0,50	56	13	24,0	6,0	4,9	5,0	0056	○	○	○	○				
M6x0,75	0,75	56	14	24,0	6,0	4,9	5,2	0062	●	●	○	○				
M7x0,75	0,75	56	14	-	6,0	4,9	6,2	0072	○	○	○	○				
M8x0,75	0,75	63	14	-	6,0	4,9	7,2	0082	●	●	○	○				
M8x1	1,00	63	17	-	6,0	4,9	7,0	0083	●	●	●	●				
M9x0,75	0,75	63	14	-	7,0	5,5	8,2	0092	○	○	○	○				
M9x1	1,00	63	17	-	7,0	5,5	8,0	0093	○	○	○	○				
M10x0,75	0,75	63	18	-	7,0	5,5	9,2	0102	○	○	○	○				
M10x1	1,00	63	18	-	7,0	5,5	9,0	0103	●	●	●	●				
M10x1,25	1,25	70	22	-	7,0	5,5	8,8	0104	●	●	●	●				
M11x0,75	0,75	63	18	-	8,0	6,2	10,2	0112	○	○	○	○				
M11x1	1,00	63	18	-	8,0	6,2	10,0	0113	○	○	○	○				
M12x1	1,00	70	18	-	9,0	7,0	11,0	0123	●	●	●	●				
M12x1,25	1,25	70	20	-	9,0	7,0	10,8	0124	●	●	●	●				
M12x1,5	1,50	70	20	-	9,0	7,0	10,5	0125	●	●	○	○				
M14x1	1,00	70	18	-	11,0	9,0	13,0	0143	●	●	○	○				
M14x1,25	1,25	70	22	-	11,0	9,0	12,8	0144	●	●	○	○				
M14x1,5	1,50	70	22	-	11,0	9,0	12,5	0145	●	●	●	●				
M15x1	1,00	70	18	-	12,0	9,0	14,0	0153	○	○	○	○				
M15x1,5	1,50	70	22	-	12,0	9,0	13,5	0155	○	○	○	○				
M16x1	1,00	80	18	-	12,0	9,0	15,0	0163	●	●	●	●				
M16x1,25	1,25	80	18	-	12,0	9,0	14,8	0164	○	○	○	○				
M16x1,5	1,50	80	22	-	12,0	9,0	14,5	0165	●	●	○	○				
M17x1	1,00	80	18	-	12,0	9,0	16,0	0173	○	○	○	○				
M17x1,5	1,50	80	22	-	12,0	9,0	15,5	0175	○	○	○	○				
M18x1	1,00	80	18	-	14,0	11,0	17,0	0183	●	●	○	○				
M18x1,5	1,50	80	22	-	14,0	11,0	16,5	0185	●	●	●	●				
M18x2	2,00	80	22	-	14,0	11,0	16,0	0186	●	●	○	○				
M20x1	1,00	80	18	-	16,0	12,0	19,0	0203	●	●	○	○				
M20x1,5	1,50	80	22	-	16,0	12,0	18,5	0205	●	●	●	●				
M20x2	2,00	80	22	-	16,0	12,0	18,0	0206	●	●	○	○				
M22x1	1,00	80	18	-	18,0	14,5	21,0	0223	●	●	○	○				

ISO Metric fine thread DIN-13



HSS
DIN 2181

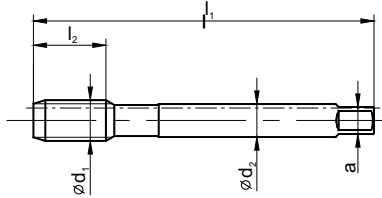

	KPL/2	F	KPL/2-LH	F-LH
	Nr1 F	F	Nr1 F	F
Material groups				
Hole type				
Quality of material	HSS	HSS	HSS	HSS
Coating				
Chamfer		~3P		~3P

4

MF ø _{d1}	P	l ₁	l ₂	l ₃	ø _{d2}	a		Norm	DIN-2181				
									Tol.	ISO2 (6H)	ISO2 (6H)	ISO2 (6H)	ISO2 (6H)
									INDEX	A1-220001	E1-131001	A1-260001	E1-231001
M22x1,5	1,5	80	22	-	18	14,5	20,5	0225	●	●	●	●	
M22x2	2,0	80	22	-	18	14,5	20,0	0226	●	●	○	○	
M24x1	1,0	90	18	-	18	14,5	23,0	0243	●	●	●	●	
M24x1,5	1,5	90	22	-	18	14,5	22,5	0245	●	●	○	○	
M24x2	2,0	90	22	-	18	14,5	22,0	0246	●	●	○	○	
M25x1	1,0	90	18	-	18	14,5	24,0	0253	○	○	○	○	
M25x1,5	1,5	90	22	-	18	14,5	23,5	0255	○	○	○	○	
M25x2	2,0	90	22	-	18	14,5	23,0	0256	○	○	○	○	
M26x1,5	1,5	90	22	-	18	14,5	24,5	0265	○	○	○	○	
M27x1	1,0	90	22	-	20	16,0	26,0	0273	○	○	○	○	
M27x1,5	1,5	90	22	-	20	16,0	25,5	0275	●	●	○	○	
M27x2	2,0	90	22	-	20	16,0	25,0	0276	●	●	○	○	
M28x1	1,0	90	20	-	20	16,0	27,0	0283	○	○	○	○	
M28x1,5	1,5	90	22	-	20	16,0	26,5	0285	●	●	○	○	
M28x2	2,0	90	22	-	20	16,0	26,0	0286	○	○	○	○	
M30x1	1,0	90	18	-	22	18,0	29,0	0303	○	○	○	○	
M30x1,5	1,5	90	22	-	22	18,0	28,5	0305	●	●	○	○	
M30x2	2,0	90	22	-	22	18,0	28,0	0306	●	●	○	○	
M30x3	3,0	125	36	-	22	18,0	27,0	0307	●	○	○	○	
M32x1,5	1,5	90	22	-	22	18,0	30,5	0325	○	○	○	○	
M32x2	2,0	90	22	-	22	18,0	30,0	0326	○	○	○	○	
M33x1,5	1,5	100	25	-	25	20,0	31,5	0335	●	●	○	○	
M33x2	2,0	100	25	-	25	20,0	31,0	0336	●	●	○	○	
M33x3	3,0	125	36	-	25	20,0	30,0	0337	●	●	○	○	
M35x1,5	1,5	100	25	-	28	22,0	33,5	0355	○	○	○	○	
M36x1,5	1,5	100	25	-	28	22,0	34,5	0365	○	○	○	○	
M36x2	2,0	125	30	-	28	22,0	34,0	0366	○	○	○	○	
M36x3	3,0	125	36	-	28	22,0	33,0	0367	○	○	○	○	
M38x1,5	1,5	100	25	-	28	22,0	36,5	0385	○	○	○	○	
M39x1,5	1,5	110	25	-	32	24,0	37,5	0395	○	○	○	○	
M39x2	2,0	125	30	-	32	24,0	37,0	0396	○	○	○	○	
M39x3	3,0	125	36	-	32	24,0	36,0	0397	○	○	○	○	
M40x1,5	1,5	110	25	-	32	24,0	38,5	0405	○	○	○	○	
M40x2	2,0	125	30	-	32	24,0	38,0	0406	●	●	○	○	
M40x3	3,0	125	36	-	32	24,0	37,0	0407	○	○	○	○	

ISO Metric fine thread DIN-13																
								KPL/2	F	KPL/2-LH	F-LH					
 								 Nr1 F		 F		 Nr1 F 		 F 		
Material groups																
Hole type																
Quality of material								HSS		HSS		HSS		HSS		
Coating																
Chamfer										~3P		~3P				
MF ød ₁	P	l ₁	l ₂	l ₃	ød ₂	a		DIN-2181								
								Norm		ISO2 (6H)						
								Tol.	ISO2 (6H)	ISO2 (6H)	ISO2 (6H)	ISO2 (6H)				
INDEX								A1-220001	E1-131001	A1-260001	E1-231001					
M42x1,5	1,5	110	25	-	32	24	40,5	0425	●	●	○	○				
M42x2	2,0	125	30	-	32	24	40,0	0426	○	○	○	○				
M42x3	3,0	125	36	-	32	24	39,0	0427	●	●	○	○				
M42x4	4,0	150	50	-	32	24	38,0	0428	○	○	○	○				
M45x1,5	1,5	110	25	-	36	29	43,5	0455	●	●	○	○				
M45x2	2,0	125	30	-	36	29	43,0	0456	○	○	○	○				
M45x3	3,0	125	36	-	36	29	42,0	0457	●	●	○	○				
M45x4	4,0	160	50	-	36	29	41,0	0458	○	○	○	○				
M48x1,5	1,5	140	25	-	36	29	46,5	0485	○	○	○	○				
M48x2	2,0	140	30	-	36	29	46,0	0486	○	○	○	○				
M48x3	3,0	140	36	-	36	29	45,0	0487	○	○	○	○				
M48x4	4,0	180	55	-	36	29	44,0	0488	○	○	○	○				
M50x1,5	1,5	140	25	-	36	29	48,5	0505	●	●	○	○				
M50x2	2,0	140	36	-	36	29	48,0	0506	○	○	○	○				
M50x3	3,0	140	36	-	36	29	47,0	0507	●	●	○	○				
M52x1,5	1,5	140	25	-	40	32	50,5	0525	●	●	○	○				
M52x2	2,0	140	36	-	40	32,0	50,00	0526	○	○	○	○				
M52x3	3,0	140	36	-	40	32,0	49,00	0527	●	●	○	○				
M52x4	4,0	180	55	-	40	32,0	48,00	0528	○	○	○	○				



4

ISO Metric fine thread DIN-13									HRC40			
									KPL/2	F		
<div style="display: flex; flex-direction: column; align-items: flex-start;"> <div style="border: 1px solid black; padding: 2px; margin-bottom: 5px;">HSSE PM</div> <div style="border: 1px solid black; padding: 2px; margin-bottom: 5px;">TS</div> <div style="border: 1px solid black; padding: 2px;">DIN 2181</div> </div>												
Material groups												
Hole type												
Quality of material									HSSE-PM		HSSE-PM	
Coating									TS		TS	
Chamfer											~3P	
M Ød ₁	P	l ₁	l ₂	l ₃	Ød ₂	a		Norm				
								DIN-2181				
								Tol.	6HX	6HX		
								INDEX	A4-225D51	A4-202D51		
M8x1	1,0	63	18	-	6	4,9	7,0	0083	●	○		
M10x1	1,0	63	18	-	7	5,5	9,0	0103	●	●		
M12x1,5	1,5	70	20	-	9	7,0	10,5	0125	●	●		
M16x1,5	1,5	70	22	-	12	9,0	14,5	0165	●	●		

Taps set HRC40 suitable for hardened steels up to 40HRC
Instruction of proper use HRC40 taps:

1. Maximum threading depth 1,5xD
2. Rigorously respect sequence of tapping procedure for hand taps sets using tap numbers in correct order
3. Please use only high quality cutting fluids (for example TEREBOR distributed by FANAR)
4. Carefully clear each tap from chips before next usage
5. Do not reverse the tap revolution before reach full depth of cut)

Taps F suitable for thread shape correction after hardening processor material galvanizing operations
Instruction of proper use F taps:

1. Please clean the threaded hole from mechanical impurities
2. Moisten both the tap and the hole with good quality tapping fluid (for example CIMTAP, TEREBOR or machine oil)
3. Enter tap into a hole by hand and make thread correction
4. Carefully clear each tap from chips before next usage

American unified coarse thread UNC, ANSI B-1.1											KPL/3		F	
<div style="border: 1px solid black; padding: 2px; display: inline-block;">HSS</div>											<div style="border: 1px solid black; padding: 2px; display: inline-block;">Nr1</div>		<div style="border: 1px solid black; padding: 2px; display: inline-block;">F</div>	
<div style="border: 1px solid black; padding: 2px; display: inline-block;">DIN 352</div>											<div style="border: 1px solid black; padding: 2px; display: inline-block;">P M K</div>		<div style="border: 1px solid black; padding: 2px; display: inline-block;">P M K</div>	
Material groups											<div style="border: 1px solid black; padding: 2px; display: inline-block;">N S H</div>		<div style="border: 1px solid black; padding: 2px; display: inline-block;">N S H</div>	
Hole type														
Quality of material											HSS		HSS	
Coating														
Chamfer													~3P	
											DIN-352			
UNC	Ød ₁	1"/P	P	l ₁	l ₂	l ₃	Ød ₂	a		Norm	2B		2B	
										Tol.	A1-230001	E1-131001		
										INDEX				
No2-56	2,184	56	0,454	36	10	10	2,8	2,1	1,85	4102	○	○		
No4-40	2,844	40	0,635	40	10	18	3,5	2,7	2,35	4104	●	●		
No5-40	3,175	40	0,640	42	10	18	3,5	2,7	2,65	4105	●	●		
No6-32	3,505	32	0,794	45	11	18	4,0	3,0	2,85	4106	●	●		
No8-32	4,166	32	0,794	48	12	23	4,5	3,4	3,50	4108	●	●		
No10-24	4,826	24	1,058	52	14	26	6,0	4,9	3,90	4110	●	●		
No12-24	5,486	24	1,058	56	16	27	6,0	4,9	4,50	4112	○	○		
1/4-20	6,350	20	1,270	56	16	27	6,0	4,9	5,10	4127	●	●		
5/16-18	7,938	18	1,411	63	20	-	6,0	4,9	6,60	4128	●	●		
3/8-16	9,525	16	1,588	70	22	-	7,0	5,5	8,00	4129	●	●		
7/16-14	11,112	14	1,814	70	22	-	8,0	6,2	9,40	4130	●	●		
1/2-13	12,700	13	1,954	80	25	-	9,0	7,0	10,80	4131	●	●		
9/16-12	14,288	12	2,117	80	26	-	11,0	9,0	12,20	4132	○	○		
5/8-11	15,875	11	2,309	80	27	-	12,0	9,0	13,50	4133	●	●		
3/4-10	19,050	10	2,540	95	30	-	14,0	11,0	16,50	4135	●	●		
7/8-9	22,225	9	2,822	100	32	-	18,0	14,5	19,50	4137	●	●		
1-8	25,400	8	3,175	110	36	-	18,0	14,5	22,25	4139	●	●		
1.1/8-7	28,575	7	3,629	125	40	-	22,0	18,0	25,00	4141	○	○		
1.1/4-7	31,750	7	3,629	125	40	-	22,0	18,0	28,00	4143	○	○		
1.3/8-6	34,925	6	4,233	150	50	-	28,0	22,0	30,75	4145	○	○		
1.1/2-6	38,100	6	4,233	150	50	-	28,0	22,0	34,00	4147	○	○		
1.3/4-5	44,450	5	5,080	160	58	-	36,0	29,0	39,50	4151	○	○		
2-4.1/2	50,800	4 1/2	5,645	180	70	-	40,0	32,0	45,00	4155	○	○		



4

American unified fine thread UNF, ANSI B-1.1												KPL/2		F					
<div style="border: 1px solid black; padding: 2px; display: inline-block;">HSS</div>												<div style="border: 1px solid black; padding: 2px; display: inline-block;">Nr1</div>		<div style="border: 1px solid black; padding: 2px; display: inline-block;">F</div>					
<div style="border: 1px solid black; padding: 2px; display: inline-block;">DIN 2181</div>												<div style="border: 1px solid black; padding: 2px; display: inline-block;">F</div>		<div style="border: 1px solid black; padding: 2px; display: inline-block;">F</div>					
Material groups												<div style="display: flex; gap: 5px;"> <div style="border: 1px solid black; padding: 1px;">P</div> <div style="border: 1px solid black; padding: 1px;">M</div> <div style="border: 1px solid black; padding: 1px;">K</div> </div>		<div style="display: flex; gap: 5px;"> <div style="border: 1px solid black; padding: 1px;">P</div> <div style="border: 1px solid black; padding: 1px;">M</div> <div style="border: 1px solid black; padding: 1px;">K</div> </div>					
Hole type																			
Quality of material												HSS		HSS					
Coating																			
Chamfer														~3P					
											Norm		DIN-2181						
UNF	Ød ₁	1"/P	P	l ₁	l ₂	l ₃	Ød ₂	a		Tol.	2B	2B							
											INDEX	A1-220001	E1-131001						
No 5-44	3,175	44	0,577	42	10	18	3,5	2,7	2,70	4205	○	○							
No 6-40	3,505	40	0,635	45	11	18	4,0	3,0	2,95	4206	○	○							
No 8-36	4,166	36	0,705	48	12	23	4,5	3,4	3,50	4208	○	○							
No 10-32	4,826	32	0,794	52	14	22	6,0	4,9	4,10	4210	●	●							
No 12-28	5,486	28	0,907	56	16	24	6,0	4,9	4,60	4212	○	○							
1/4-28	6,350	28	0,907	56	16	24	6,0	4,9	5,50	4227	●	●							
5/16-24	7,938	24	1,058	63	17	-	6,0	4,9	6,90	4228	○	○							
3/8-24	9,525	24	1,058	63	18	-	7,0	5,5	8,50	4229	●	●							
7/16-20	11,112	20	1,270	70	20	-	8,0	6,2	9,90	4230	●	●							
1/2-20	12,700	20	1,270	70	20	-	9,0	7,0	11,50	4231	●	●							
9/16-18	14,288	18	1,411	80	20	-	12,0	9,0	12,90	4232	●	○							
5/8-18	15,875	18	1,411	80	22	-	12,0	9,0	14,50	4233	○	○							
3/4-16	19,050	16	1,588	80	22	-	14,0	11,0	17,50	4235	●	●							
7/8-14	22,225	14	1,814	80	22	-	18,0	14,5	20,40	4237	○	○							
1-12	25,400	12	2,117	90	22	-	18,0	14,5	23,25	4239	●	●							
1.1/8-12	28,575	12	2,117	90	22	-	22,0	18,0	26,50	4241	○	○							
1.1/4-12	31,750	12	2,117	90	22	-	22,0	18,0	29,50	4243	○	○							
1.3/8-12	34,925	12	2,117	125	36	-	28,0	22,0	32,75	4245	○	○							
1.1/2-12	38,100	12	2,117	125	36	-	28,0	22,0	36,00	4247	○	○							

Whitworth pipe thread G, DIN-ISO 228																				
											KPL/2	F	KPL/2-LH	F-LH						
											 Nr1		 F		 Nr1		 F			
Material groups																				
Hole type											 < 2,5d		 < 2,5d		 < 2,5d		 < 2,5d			
Quality of material											HSS		HSS		HSS		HSS			
Coating																				
Chamfer													~3P				~3P			
G	Ød ₁	1"/P	P	l ₁	l ₂	l ₃	Ød ₂	a		Norm	DIN-5157									
											Tol.									
											INDEX	A1-220001	E1-131001	A1-260001	E1-231001					
G1/16	7,723	28	0,907	63	18	-	6	4,9	6,80	3121	○	○	○	○						
G1/8	9,728	28	0,907	63	20	-	7	5,5	8,80	3123	●	●	○	○						
G1/4	13,157	19	1,337	70	22	-	11	9,0	11,80	3127	●	●	○	○						
G3/8	16,662	19	1,337	70	22	-	12	9,0	15,25	3129	●	●	●	●						
G1/2	20,955	14	1,814	80	22	-	16	12,0	19,00	3131	●	●	●	●						
G5/8	22,911	14	1,814	80	22	-	18	14,5	21,00	3133	●	●	○	○						
G3/4	26,441	14	1,814	90	22	-	20	16,0	24,50	3135	●	●	●	●						
G7/8	30,201	14	1,814	90	22	-	22	18,0	28,25	3137	●	●	○	○						
G1	33,249	11	2,309	100	25	-	25	20,0	30,75	3139	●	●	●	●						
G1.1/8	37,897	11	2,309	125	36	-	28	22,0	35,50	3141	○	○	○	○						
G1.1/4	41,910	11	2,309	125	36	-	32	24,0	39,50	3143	●	●	○	○						
G1.3/8	44,323	11	2,309	125	36	-	36	29,0	41,75	3145	○	○	○	○						
G1.1/2	47,803	11	2,309	140	40	-	36	29,0	45,25	3147	●	●	○	○						
G1.3/4	53,769	11	2,309	140	40	-	40	32,0	51,00	3151	○	○	○	○						
G2	59,614	11	2,309	160	40	-	45	35,0	57,00	3155	○	○	○	○						



4

Whitworth pipe thread G, DIN-ISO 228										INOX					
 										KPL/2		F			
										 Nr1 F		 F			
Material groups															
Hole type															
Quality of material										HSSE		HSSE			
Coating															
Chamfer												~3P			
										Norm		DIN-5157			
										Tol.					
										INDEX		A2-225801	A2-202801		
G-1/8"	9,728	28	0,907	63	20	7	5,5	8,8	3123	○		○			
G-1/4"	13,157	19	1,337	70	22	11	9	11,8	3127	○		○			
G-3/8"	16,662	19	1,337	70	22	12	9	15,25	3129	○		○			
G-1/2"	20,955	14	1,814	80	22	16	12	19,0	3131	○		○			

Whitworth pipe thread G, DIN-ISO 228										HRC40						
										KPL/2	F					
 										 Nr1	 F	 F				
Material groups																
Hole type										 < 1,5d	 < 1,5d					
Quality of material										HSSE-PM	HSSE-PM					
Coating										TS	TS					
Chamfer											~3P					
										Norm	DIN-5157					
										ToL.						
										INDEX	A4-225D51	A4-202D51				
G	Ød ₁	1"/P	P	l ₁	l ₂	Ød ₂	a									
G-1/8"	9,728	28	0,907	63	20	7,0	5,5	8,80	3123	●	●					
G-1/4"	13,157	19	1,337	70	22	11,0	9,0	11,80	3127	●	●					
G-3/8"	16,662	19	1,337	70	22	12,0	9,0	15,25	3129	●	●					
G-1/2"	20,955	14	1,814	80	22	16,0	12,0	19,00	3131	●	●					



Taps set HRC40 suitable for hardened steels up to 40HRC

Instruction of proper use HRC40 taps:

1. Maximum threading depth 1,5xD
2. Rigourosly respect sequence of tapping procedure for hand taps sets using tap numbers in corect order
3. Plese use only high quality cutting fluids (for example TEREBOR distributed by FANAR)
4. Carefully clear each tap from chips before next usage
5. Do not reverse the tap revolution before reach full depth of cut)

Taps F suitable for thread shape correction after hardening processor material galvanizing operations

Instruction of proper use F taps:

1. Please clean the threaded hole from mechanical impurities
2. Moisten bothe the tap and the hole with good quality tapping fluid (for example CIMTAP, TEREBOR or machine oil)
3. Enter tap into a hole by hand and make thread correction
4. Carefully clear each tap from chips before next usage

4

British Whitworth fine thread BSF, BS-84:1956											KPL/3		F	
HSS														
DIN 352														
Material groups														
Hole type														
Quality of material											HSS		HSS	
Coating														
Chamfer													~3P	
BSW	ød ₁	1"/P	P	l ₁	l ₂	l ₃	ød ₂	a		Norm	DIN-352			
											Tol.	normal		normal
											INDEX	A1-230001	E1-131001	
1/8-40	3,180	40	0,635	42	10	18	3,5	2,7	2,55	7123	●	●		
3/16-24	4,760	24	1,058	52	14	26	6	4,9	3,70	7125	●	●		
1/4-20	6,35	20	1,270	56	16	27	6	4,9	5,10	7127	●	●		
5/16-18	7,938	18	1,411	63	20	-	6	4,9	6,50	7128	○	○		
3/8-16	9,525	16	1,588	70	22	-	7	5,5	7,90	7129	●	●		
7/16-14	11,112	14	1,814	70	22	-	8	6,2	9,25	7130	○	○		
1/2-12	12,7	12	2,117	80	25	-	9	7,0	10,50	7131	●	●		
9/16-12	14,288	12	2,117	80	26	-	11	9,0	12,00	7132	○	○		
5/8-11	15,875	11	2,309	80	27	-	12	9,0	13,50	7133	○	○		
3/4-10	19,050	10	2,504	95	30	-	14	11,0	16,40	7135	●	●		
7/8-9	22,225	9	2,822	100	32	-	18	14,5	19,25	7137	○	○		
1-8	25,400	8	3,175	110	36	-	18	14,5	22,00	7139	●	●		
1.1/8-7	28,575	7	3,629	125	40	-	22	18,0	24,75	7141	○	○		
1.1/4-7	31,750	7	3,629	125	40	-	22	18,0	27,75	7143	○	○		
1.1/2-6	38,100	6	4,233	150	50	-	28	22,0	33,50	7147	○	○		
1.3/4-5	44,450	5	5,080	160	58	-	36	29,0	39,00	7151	○	○		
2-4.1/2	50,800	4 1/2	5,645	180	70	-	40	32,0	44,50	7155	○	○		

British Whitworth fine thread BSF, BS-84:1956											KPL/2		F								
<div style="display: flex; flex-direction: column; align-items: center;"> <div style="border: 1px solid black; padding: 2px; margin: 2px;">HSS</div> <div style="border: 1px solid black; padding: 2px; margin: 2px;">DIN 2181</div> </div>											 Nr1		 F		 F						
Material groups											<div style="display: flex; gap: 5px;"> <div style="border: 1px solid black; padding: 1px;">P</div> <div style="border: 1px solid black; padding: 1px;">M</div> <div style="border: 1px solid black; padding: 1px;">K</div> </div> <div style="display: flex; gap: 5px; margin-top: 2px;"> <div style="border: 1px solid black; padding: 1px;">N</div> <div style="border: 1px solid black; padding: 1px;">S</div> <div style="border: 1px solid black; padding: 1px;">H</div> </div>		<div style="display: flex; gap: 5px;"> <div style="border: 1px solid black; padding: 1px;">P</div> <div style="border: 1px solid black; padding: 1px;">M</div> <div style="border: 1px solid black; padding: 1px;">K</div> </div> <div style="display: flex; gap: 5px; margin-top: 2px;"> <div style="border: 1px solid black; padding: 1px;">N</div> <div style="border: 1px solid black; padding: 1px;">S</div> <div style="border: 1px solid black; padding: 1px;">H</div> </div>								
Hole type											 < 2,5d		 < 2,5d								
Quality of material											HSS		HSS								
Coating																					
Chamfer													~3P								
BSF	ød ₁	1"/P	P	l ₁	l ₂	l ₃	ød ₂	a		Norm	DIN-2181										
											Tol.	normal	normal								
										INDEX	A1-220001	E1-131001									
3/16-32	4,762	32	0,794	50	14	25	6	4,9	4,00	7225	●	●									
1/4-26	6,350	26	0,977	56	14	21	6	4,9	5,30	7227	●	●									
5/16-22	7,937	22	1,155	63	19	-	6	4,9	6,80	7228	○	○									
3/8-20	9,525	20	1,270	70	20	-	7	5,5	8,30	7229	●	●									
7/16-18	11,112	18	1,411	70	20	-	8	6,2	9,70	7230	○	○									
1/2-16	12,700	16	1,588	70	20	-	9	7,0	11,10	7231	●	●									
9/16-16	14,288	16	1,588	80	20	-	12	9,0	12,70	7232	○	○									
5/8-14	15,875	14	1,814	80	27	-	12	9,0	14,00	7233	○	○									
3/4-12	19,050	12	2,117	80	22	-	14	11,0	16,75	7235	●	●									
7/8-11	22,225	11	2,309	80	22	-	18	14,5	19,75	7237	○	○									
1-10	25,400	10	2,504	110	36	-	18	14,5	22,75	7239	●	●									



SCREWING DIES

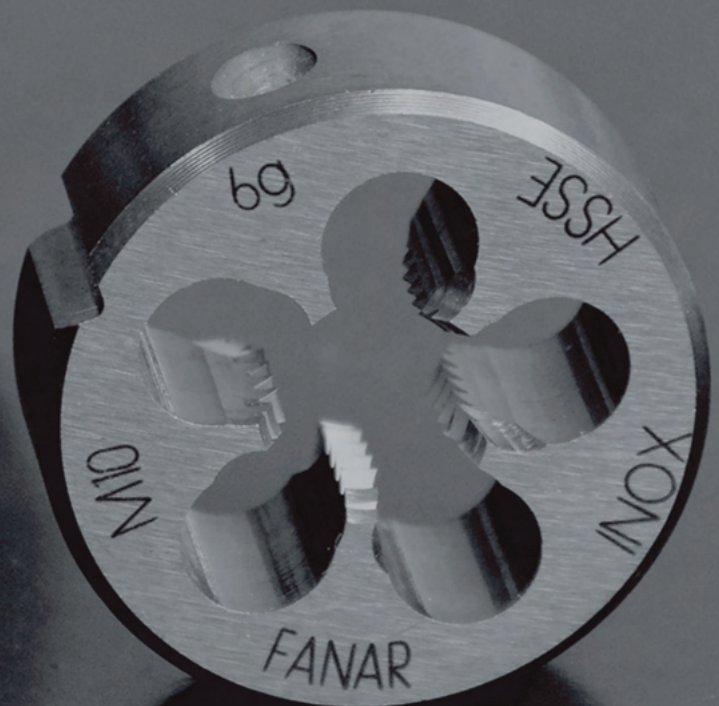

SELECTION TABLE

6

CATALOGUE PAGES

127 - 137

M	DIN-EN 22568	<i>800</i>	<i>800</i> SPN	<i>Ms</i>	<i>INOX</i>	127
MF	DIN-EN 22568	<i>800</i>	<i>800</i> SPN	<i>Ms</i>	<i>INOX</i>	128 - 130
UNC	DIN-EN 22568				<i>800</i>	131
UNF	DIN-EN 22568				<i>800</i>	132
G	DIN-EN 24231		<i>800</i>	<i>Ms</i>	<i>INOX</i>	133
R	DIN-EN 24230				<i>800</i>	134
BSW	DIN-EN 22568				<i>800</i>	135
BSF	DIN-EN 22568				<i>800</i>	136
NPT	DIN-EN 24230				<i>800</i>	137

ISO Metric coarse thread DIN-13						800	800 LH	800 SPN	Ms	INOX
<p>HSS</p> <p>HSSE</p> <p>DIN-EN 22 568</p> <p>*SPN - Spiral point</p>										
Material groups						P M K N S H	P M K N S H	P M K N S H	P M K N S H	P M K N S H
Execution							LH	SPN*		SPN
Quality of material						HSS	HSS	HSS	HSS	HSSE
Chamfer						1,75P	1,75P	1,75P	1,25P	2,25P
M Ø _{d1}	P	ØDxE	W		DIN-EN 22 568					
					Norm					
					Tol.	6g	6g	6g	6g	6g
					INDEX	N1-121001	N1-111001	N1-141001	N1-164001	N2-188001
M 1	0,25	16 x 5	3	0,96	0010	●	-	-	-	-
M 1,1	0,25	16 x 5	3	1,05	0011	●	-	-	-	-
M 1,2	0,25	16 x 5	3	1,15	0012	●	-	-	-	-
M 1,4	0,3	16 x 5	3	1,35	0014	●	-	-	-	-
M 1,6	0,35	16 x 5	3	1,55	0016	●	-	-	-	-
M 1,8	0,35	16 x 5	3	1,75	0018	●	-	-	-	-
M 2	0,4	16 x 5	3	1,95	0020	●	-	-	-	-
M 2,2	0,45	16 x 5	3	2,15	0022	●	-	-	-	-
M 2,5	0,45	16 x 5	3	2,42	0025	●	-	-	-	-
M 3	0,5	20 x 5	3	2,92	0030	●	●	●	●	●
M 3,5	0,6	20 x 5	3	3,41	0035	●	○	●	○	○
M 4	0,7	20 x 5	3	3,90	0040	●	●	●	●	●
M 4,5	0,75	20 x 7	3	4,40	0045	●	○	●	○	○
M 5	0,8	20 x 7	3	4,90	0050	●	●	●	●	●
M 6	1	20 x 7	4	5,88	0060	●	●	●	●	●
M 7	1	25 x 9	4	6,88	0070	●	○	●	○	○
M 8	1,25	25 x 9	4	7,86	0080	●	●	●	●	●
M 9	1,25	25 x 9	4	8,86	0090	●	○	●	○	○
M 10	1,5	30 x 11	4	9,85	0100	●	●	●	●	●
M 11	1,5	30 x 11	4	10,85	0110	●	○	●	○	○
M 12	1,75	38 x 14	4	11,83	0120	●	●	●	○	●
M 14	2	38 x 14	4	13,82	0140	●	●	●	○	●
M 16	2	45 x 18	5	15,82	0160	●	●	●	○	●
M 18	2,5	45 x 18	5	17,79	0180	●	●	●	○	●
M 20	2,5	45 x 18	5	19,79	0200	●	●	●	○	●
M 22	2,5	55 x 22	5	21,79	0220	●	●	●	○	●
M 24	3	55 x 22	5	23,76	0240	●	●	●	○	●
M 27	3	65 x 25	5	26,76	0270	●	●	●	○	●
M 30	3,5	65 x 25	6	29,73	0300	●	●	●	○	●
M 33	3,5	65 x 25	6	32,73	0330	●	●	●	○	○
M 36	4	65 x 25	7	35,70	0360	●	●	●	○	○
M 39	4	75 x 30	7	38,70	0390	●	○	○	○	○
M 42	4,5	75 x 30	7	41,68	0420	●	○	○	○	○
M 45	4,5	90 x 36	7	44,68	0450	●	○	○	○	○
M 48	5	90 x 36	7	47,66	0480	●	○	○	○	○
M 52	5	90 x 36	8	51,66	0520	●	○	○	○	○
M 56	5,5	105 x 36	7	55,65	0560	○	○	○	○	○
M 60	5,5	105 x 36	8	59,65	0600	○	○	○	○	○
M 64	6	120 x 36	7	63,62	0640	○	○	○	○	○
M 68	6	120 x 36	8	67,62	0680	○	○	○	○	○

ISO Metric fine thread DIN-13

800

800

800
SPN

Ms

INOX

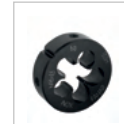
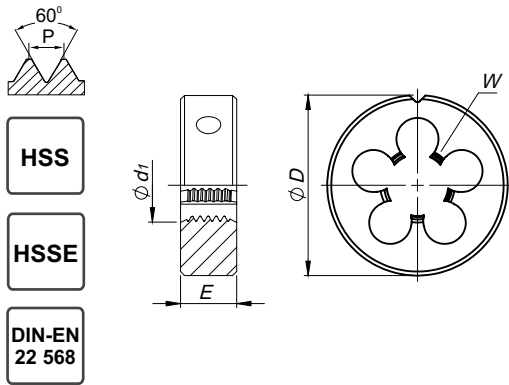

*SPN - Spiral point

Material groups



Execution

LH

SPN

SPN

Quality of material

HSS

HSS

HSS

HSS

HSSE

Chamfer

1,75P

1,75P

1,75P

1,25P

2,25P

5

M Ød ₁	P	ØDxE	W		Norm	DIN-EN 22 568					
						Tol.	6g	6g	6g	6g	6g
						INDEX	N1-121001	N1-111001	N1-141001	N1-164001	N2-188001
M 3,5 x 0,5	0,5	20 x 5	3	3,43	0037	○	○	○	○	○	
M 4 x 0,5	0,5	20 x 5	4	3,92	0041	●	○	●	●	●	
M 4,5 x 0,5	0,5	20 x 5	4	4,43	0046	○	○	○	○	○	
M 5 x 0,5	0,5	20 x 5	4	4,92	0051	●	○	●	●	●	
M 5 x 0,75	0,75	20 x 5	4	4,91	0052	○	○	○	○	○	
M 5,5 x 0,5	0,5	20 x 5	4	5,43	0056	○	○	○	○	○	
M 5,5 x 0,75	0,75	20 x 7	4	5,42	0057	○	○	○	○	○	
M 6 x 0,5	0,5	20 x 5	4	5,92	0061	●	○	●	○	●	
M 6 x 0,75	0,75	20 x 7	4	5,90	0062	●	○	●	●	●	
M 7 x 0,75	0,75	25 x 9	4	6,90	0072	●	○	●	●	●	
M 8 x 0,5	0,5	25 x 9	4	7,92	0081	●	○	●	●	●	
M 8 x 0,75	0,75	25 x 9	4	7,90	0082	●	●	●	●	●	
M 8 x 1	1	25 x 9	4	7,88	0083	●	●	●	●	●	
M 9 x 0,75	0,75	25 x 9	4	8,90	0092	●	●	●	●	●	
M 9 x 1	1	25 x 9	4	8,88	0093	●	●	●	●	●	
M 10 x 0,75	0,75	30 x 11	4	9,90	0102	●	●	●	●	●	
M 10 x 1	1	30 x 11	5	9,88	0103	●	●	●	●	●	
M 10 x 1,25	1,25	30 x 11	4	9,86	0104	●	●	●	●	●	
M 11 x 0,75	0,75	30 x 11	5	10,91	0112	●	○	●	●	●	
M 11 x 1	1	30 x 11	4	10,88	0113	●	○	●	●	●	
M 12 x 1	1	38 x 10	4	11,88	0123	●	●	●	●	●	
M 12 x 1,25	1,25	38 x 10	4	11,86	0124	●	●	●	●	●	
M 12 x 1,5	1,5	38 x 10	4	11,85	0125	●	●	●	●	●	
M 14 x 1	1	38 x 10	5	13,88	0143	●	●	○	●	●	
M 14 x 1,5	1,5	38 x 10	5	13,85	0145	●	●	●	●	●	
M 15 x 1	1	38 x 10	5	14,88	0153	●	○	○	●	●	
M 15 x 1,5	1,5	38 x 10	5	14,85	0155	●	○	○	●	●	
M 16 x 1	1	45 x 14	5	15,88	0163	●	●	○	●	●	
M 16 x 1,5	1,5	45 x 14	5	15,85	0165	●	●	●	●	●	
M 17 x 1	1	45 x 14	5	16,88	0173	●	○	○	●	●	
M 17 x 1,5	1,5	45 x 14	5	16,85	0175	●	○	○	●	●	
M 18 x 1	1	45 x 14	5	17,88	0183	●	●	○	●	●	
M 18 x 1,5	1,5	45 x 14	5	17,85	0185	●	●	●	●	●	
M 18 x 2	2	45 x 14	5	17,82	0186	●	●	●	●	●	
M 20 x 1	1	45 x 14	6	19,80	0203	●	●	●	●	●	
M 20 x 1,5	1,5	45 x 14	6	19,85	0205	●	●	●	●	●	
M 20 x 2	2	45 x 14	6	19,82	0206	●	●	○	●	●	
M 22 x 1	1	55 x 16	6	21,88	0223	●	●	○	●	●	
M 22 x 1,5	1,5	55 x 16	6	21,85	0225	●	●	●	●	●	
M 22 x 2	2	55 x 16	6	21,82	0226	●	●	○	●	●	
M 24 x 1	1	55 x 16	6	23,88	0243	●	●	○	●	●	
M 24 x 1,5	1,5	55 x 16	6	23,85	0245	●	●	●	●	●	

● Available from stock
○ On request

ISO Metric fine thread DIN-13						800	800	800 SPN	Ms	INOX	
HSS HSSE DIN-EN 22 568											
*SPN - Spiral point											
Material groups											
Execution							LH	SPN		SPN	
Quality of material						HSS	HSS	HSS	HSS	HSSE	
Chamfer						1,75P	1,75P	1,75P	1,25P	2,25P	
M Ød ₁	P	ØDxE	W		Norm DIN-EN 22 568						
					Tol.	6g	6g	6g	6g	6g	
						INDEX	N1-121001	N1-111001	N1-141001	N1-164001	N2-188001
M 24 x 2	2	55 x 16	6	23,82	0246	●	●	○	○	○	
M 25 x 1	1	55 x 16	6	24,88	0253	●	○	○	○	○	
M 25 x 1,5	1,5	55 x 16	6	24,85	0255	●	○	○	○	○	
M 25 x 2	2	55 x 16	6	24,82	0256	●	○	○	○	○	
M 26 x 1,5	1,5	55 x 16	6	25,85	0265	●	○	○	○	○	
M 27 x 1	1	65 x 18	6	26,88	0273	●	○	○	○	○	
M 27 x 1,5	1,5	65 x 18	6	26,85	0275	●	○	○	○	○	
M 27 x 2	2	65 x 18	6	26,82	0276	●	○	○	○	○	
M 28 x 1	1	65 x 18	6	27,88	0283	●	○	○	○	○	
M 28 x 1,5	1,5	65 x 18	6	27,85	0285	●	○	○	○	○	
M 28 x 2	2	65 x 18	6	27,82	0286	●	○	○	○	○	
M 30 x 1	1	65 x 18	6	29,88	0303	●	○	○	○	○	
M 30 x 1,5	1,5	65 x 18	6	29,85	0305	●	○	○	○	○	
M 30 x 2	2	65 x 18	6	29,82	0306	●	○	○	○	○	
M 30 x 3	3	65 x 25	6	29,76	0307	●	○	○	○	○	
M 32 x 1,5	1,5	65 x 18	7	31,85	0325	●	○	○	○	○	
M 32 x 2	2	65 x 18	7	31,82	0326	●	○	○	○	○	
M 33 x 1,5	1,5	65 x 18	7	32,85	0335	●	○	○	○	○	
M 33 x 2	2	65 x 18	7	32,82	0336	●	○	○	○	○	
M 33 x 3	3	65 x 25	7	32,76	0337	●	○	○	○	○	
M 35 x 1,5	1,5	65 x 18	7	34,85	0355	●	○	○	○	○	
M 36 x 1,5	1,5	65 x 18	7	35,85	0365	●	○	○	○	○	
M 36 x 2	2	65 x 18	7	35,82	0366	●	○	○	○	○	
M 36 x 3	3	65 x 25	7	35,76	0367	●	○	○	○	○	
M 38 x 1,5	1,5	75 x 20	7	37,85	0385	●	○	○	○	○	
M 39 x 1,5	1,5	75 x 20	7	38,85	0395	●	○	○	○	○	
M 39 x 2	2	75 x 20	7	38,82	0396	●	○	○	○	○	
M 39 x 3	3	75 x 30	7	38,76	0397	●	○	○	○	○	
M 40 x 1,5	1,5	75 x 20	7	39,85	0405	●	○	○	○	○	
M 40 x 2	2	75 x 20	7	39,82	0406	●	○	○	○	○	
M 40 x 3	3	75 x 30	7	39,76	0407	●	○	○	○	○	
M 42 x 1,5	1,5	75 x 20	7	41,85	0425	●	○	○	○	○	
M 42 x 2	2	75 x 20	8	41,82	0426	●	○	○	○	○	
M 42 x 3	3	75 x 30	7	41,76	0427	●	○	○	○	○	
M 45 x 1,5	1,5	90 x 22	7	44,85	0455	●	○	○	○	○	
M 45 x 2	2	90 x 22	7	44,82	0456	●	○	○	○	○	
M 45 x 3	3	90 x 36	7	44,76	0457	●	○	○	○	○	
M 48 x 1,5	1,5	90 x 22	7	47,85	0485	●	○	○	○	○	
M 48 x 2	2	90 x 22	7	47,82	0486	●	○	○	○	○	
M 48 x 3	3	90 x 36	7	47,76	0487	●	○	○	○	○	
M 48 x 4	4	90 x 36	7	47,73	0488	●	○	○	○	○	
M 50 x 1,5	1,5	90 x 22	8	49,85	0505	●	○	○	○	○	



5

ISO Metric fine thread DIN-13						800	800	800 SPN	Ms	INOX																														
<p>*SPN - Spiral point</p>																																								
Material groups						<table border="1"> <tr><td>P</td><td>M</td><td>K</td></tr> <tr><td>N</td><td>S</td><td>H</td></tr> </table>	P	M	K	N	S	H	<table border="1"> <tr><td>P</td><td>M</td><td>K</td></tr> <tr><td>N</td><td>S</td><td>H</td></tr> </table>	P	M	K	N	S	H	<table border="1"> <tr><td>P</td><td>M</td><td>K</td></tr> <tr><td>N</td><td>S</td><td>H</td></tr> </table>	P	M	K	N	S	H	<table border="1"> <tr><td>P</td><td>M</td><td>K</td></tr> <tr><td>N</td><td>S</td><td>H</td></tr> </table>	P	M	K	N	S	H	<table border="1"> <tr><td>P</td><td>M</td><td>K</td></tr> <tr><td>N</td><td>S</td><td>H</td></tr> </table>	P	M	K	N	S	H
P	M	K																																						
N	S	H																																						
P	M	K																																						
N	S	H																																						
P	M	K																																						
N	S	H																																						
P	M	K																																						
N	S	H																																						
P	M	K																																						
N	S	H																																						
Execution							LH	SPN		SPN																														
Quality of material						HSS	HSS	HSS	HSS	HSSE																														
Chamfer						1,75P	1,75P	1,75P	1,25P	2,25P																														
M Ød ₁	P	ØDxE	W		DIN-EN 22 568																																			
					Norm	6g																																		
					Tol.																																			
					INDEX	N1-121001	N1-111001	N1-141001	N1-164001	N2-188001																														
M 50 x 2	2	90 x 22	8	49,82	0506	●	○	○	○	○																														
M 50 x 3	3	90 x 36	8	49,76	0507	●	○	○	○	○																														
M 52 x 1,5	1,5	90 x 22	8	51,85	0525	●	○	○	○	○																														
M 52 x 2	2	90 x 22	8	51,82	0526	●	○	○	○	○																														
M 52 X 3	3	90 x 36	8	51,76	0527	●	○	○	○	○																														
M 52 x 4	4	90 x 36	8	51,73	0528	●	○	○	○	○																														
M 55 x 1,5	1,5	105 x 22	8	54,85	0555	○	○	○	○	○																														
M 55 x 2	2	105 x 22	7	54,82	0556	○	○	○	○	○																														
M 55 x 3	3	105 x 36	7	54,76	0557	○	○	○	○	○																														
M 55 x 4	4	105 x 36	7	54,73	0558	○	○	○	○	○																														
M 56 x 1,5	2	105 x 22	8	55,85	0565	○	○	○	○	○																														
M 56 x 2	2	105 x 22	8	55,82	0566	○	○	○	○	○																														
M 56 x 3	3	105 x 36	8	55,76	0567	○	○	○	○	○																														
M 56 x 4	4	105 x 36	7	55,73	0568	○	○	○	○	○																														

American unified coarse thread UNC, ANSI B-1.1								800										
Material groups								<table border="1"> <tr> <td>P</td> <td>M</td> <td>K</td> </tr> <tr> <td>N</td> <td>S</td> <td>H</td> </tr> </table>		P	M	K	N	S	H			
P	M	K																
N	S	H																
Execution								HSS										
Quality of material								HSS										
Chamfer								1,75P										
UNC	Ød ₁	1"/P	P	ØD x E	W		Norm		INDEX									
							DIN-EN 22 568											
							Tol.		2A									
							INDEX		N1-121001									
No 5 - 40	3,175	40	0,635	20 x 5	3	3,09	4105		●									
No 6 - 32	3,505	32	0,794	20 x 5	3	3,41	4106		●									
No 8 - 32	4,166	32	0,794	20 x 7	3	4,07	4108		●									
No 10 - 24	4,826	24	1,058	20 x 7	3	4,71	4110		●									
No 12 - 24	5,486	24	1,058	20 x 7	4	5,37	4112		●									
1/4 - 20	6,35	20	1,270	20 x 7	4	6,22	4127		●									
5/16 - 18	7,938	18	1,411	25 x 9	4	7,80	4128		●									
3/8 - 16	9,525	16	1,588	30 x 11	4	9,37	4129		●									
7/16 - 14	11,112	14	1,814	30 x 11	4	10,95	4130		●									
1/2 - 13	12,7	13	1,954	38 x 14	4	12,52	4131		●									
9/16 - 12	14,288	12	2,117	38 x 14	4	14,10	4132		●									
5/8 - 11	15,875	11	2,309	45 x 18	5	15,68	4133		●									
3/4 - 10	19,05	10	2,540	45 x 18	5	18,84	4135		●									
7/8 - 9	22,225	9	2,822	55 x 22	5	22,00	4137		●									
1 - 8	25,4	8	3,175	55 x 22	5	25,16	4139		●									
1.1/8 - 7	28,575	7	3,629	65 x 25	5	28,31	4141		○									
1.1/4 - 7	31,75	7	3,629	65 x 25	6	31,49	4143		○									
1.3/8 - 6	34,925	6	4,233	65 x 25	7	34,63	4145		○									
1.1/2 - 6	38,1	6	4,233	75 x 30	6	37,80	4147		○									
1.3/4 - 5	44,45	5	5,080	90 x 36	6	44,12	4151		○									
2 - 4.1/2	50,8	4.1/2	5,645	90 x 36	7	50,45	4155		○									



American unified fine thread UNF, ANSI B-1.1

800

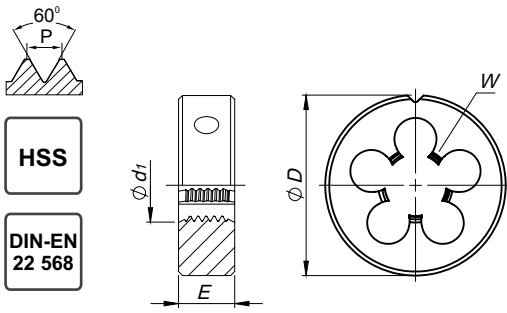

Material groups



Execution

Quality of material

HSS

Chamfer

1,75P

5

UNF	Ød,	1"/P	P	ØD x E	W		Norm	INDEX
							DIN-EN 22 568	
							Tol.	2A
								N1-121001
No 5 - 44	3,175	44	0,577	20 x 5	3	3,10	4205	●
No 6 - 40	3,505	40	0,635	20 x 5	3	3,42	4206	●
No 8 - 36	4,166	36	0,705	20 x 7	3	4,08	4208	●
No 10 - 32	4,826	32	0,794	20 x 7	3	4,73	4210	●
No 12 - 28	5,486	28	0,907	20 x 7	4	5,38	4212	●
1/4 - 28	6,35	28	0,907	20 x 7	4	6,24	4227	●
5/16 - 24	7,938	24	1,058	25 x 9	5	7,82	4228	●
3/8 - 24	9,525	24	1,058	30 x 11	4	9,41	4229	●
7/16 - 20	11,112	20	1,270	30 x 11	5	10,98	4230	●
1/2 - 20	12,7	20	1,270	38 x 10	5	12,56	4231	●
9/16 - 18	14,288	18	1,411	38 x 10	5	14,14	4232	●
5/8 - 18	15,875	18	1,411	45 x 14	5	15,73	4233	●
3/4 - 16	19,05	16	1,588	45 x 14	6	18,89	4235	●
7/8 - 14	22,225	14	1,814	55 x 16	5	22,05	4237	●
1 - 12	25,4	12	2,117	55 x 16	6	25,21	4239	●
1.1/8 - 12	28,575	12	2,117	65 x 18	6	28,38	4241	○
1.1/4 - 12	31,75	12	2,117	65 x 18	6	31,55	4243	○
1.3/8 - 12	34,925	12	2,117	65 x 18	7	34,73	4245	○
1.1/2 - 12	38,1	12	2,117	75 x 20	8	37,90	4247	○

Whitworth pipe thread G, DIN-ISO 228							800	800	Ms	INOX																											
<p>HSS</p> <p>HSSE</p> <p>DIN-EN 24 231</p>																																					
Material groups							<table border="1"> <tr><td>P</td><td>M</td><td>K</td></tr> <tr><td>N</td><td>S</td><td>H</td></tr> </table>	P	M	K	N	S	H	<table border="1"> <tr><td>P</td><td>M</td><td>K</td></tr> <tr><td>N</td><td>S</td><td>H</td></tr> </table>	P	M	K	N	S	H	<table border="1"> <tr><td>P</td><td>M</td><td>K</td></tr> <tr><td>N</td><td>S</td><td>H</td></tr> </table>	P	M	K	N	S	H	<table border="1"> <tr><td>P</td><td>M</td><td>K</td></tr> <tr><td>N</td><td>S</td><td>H</td></tr> </table>	P	M	K	N	S	H			
P	M	K																																			
N	S	H																																			
P	M	K																																			
N	S	H																																			
P	M	K																																			
N	S	H																																			
P	M	K																																			
N	S	H																																			
Execution								LH		SPN																											
Quality of material							HSS	HSS	HSS	HSSE																											
Chamfer							1,75P	1,75P	1,25P	2,25P																											
G	Ød,	1"/P	P	ØD x E	W		DIN-EN 24231																														
							Norm	Tol.	INDEX	N1-121001			N1-111001	N1-164001	N2-188001																						
G1/8	9,73	28	0,907	30 x 11	4	9,62	3123	●	○	●	●																										
G1/4	13,16	19	1,337	38 x 10	4	13,03	3127	●	●	●	●																										
G3/8	16,66	19	1,337	45 x 14	5	16,54	3129	●	●	●	●																										
G1/2	20,96	14	1,814	45 x 14	6	20,81	3131	●	●	●	●																										
G5/8	22,91	14	1,814	55 x 16	5	22,77	3133	●	○	○	○																										
G3/4	26,44	14	1,814	55 x 16	6	26,30	3135	●	●	●	●																										
G7/8	30,20	14	1,814	65 x 18	6	30,06	3137	●	○	○	○																										
G1	33,25	11	2,309	65 x 18	7	33,07	3139	●	●	●	●																										
G1.1/8	37,90	11	2,309	75 x 20	7	37,72	3141	○	○	○	○																										
G1.1/4	41,91	11	2,309	75 x 20	8	41,73	3143	●	○	○	○																										
G1.3/8	44,32	11	2,309	90 x 22	7	44,14	3145	○	○	○	○																										
G1.1/2	47,80	11	2,309	90 x 22	7	47,62	3147	●	○	○	○																										
G1.3/4	53,75	11	2,309	105 x 22	8	53,57	3151	○	○	○	○																										
G2	59,61	11	2,309	105 x 22	8	59,43	3155	○	○	○	○																										
G2.1/4	65,71	11	2,309	120 x 22	8	65,49	3157	○	○	○	○																										



Whitworth pipe external thread R, ISO-7/1

800

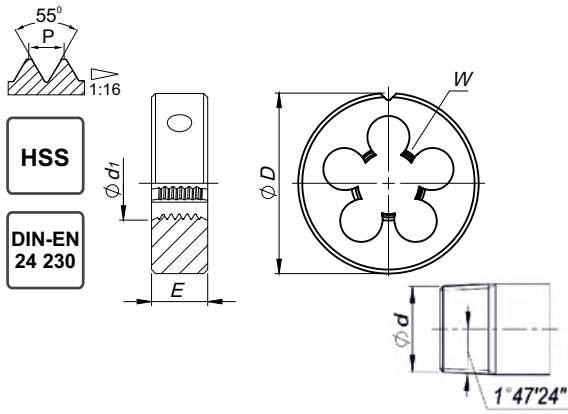

Material groups



Execution

Quality of material

HSS

Chamfer

2P

5

R	Ød ₁	1"/P	P	ØD x E	W		Norm				
							DIN-EN 24 230				
							Tol.				
							INDEX	N1-121001			
R-1/8"	9,728	28	0,907	30 x 11	5	9,48	3423	●			
R-1/4"	13,157	19	1,337	38 x 14	5	12,78	3427	●			
R-3/8"	16,662	19	1,337	45 x 18	5	16,26	3429	●			
R-1/2"	20,955	14	1,814	55 x 22	5	20,44	3431	●			
R-3/4"	26,441	14	1,814	55 x 22	6	25,85	3435	●			
R-1"	33,249	11	2,309	65 x 25	7	32,60	3439	●			

Whitworth thread BSW BS-84:2007								<i>800</i>									
Material groups								<table border="1"> <tr> <td>P</td> <td>M</td> <td>K</td> </tr> <tr> <td>N</td> <td>S</td> <td>H</td> </tr> </table>				P	M	K	N	S	H
P	M	K															
N	S	H															
Execution																	
Quality of material								HSS									
Chamfer								1,75P									
BSW	Ød ₁	1"/P	P	ØD x E	W		Norm	DIN-EN 22 568									
							Tol.	medium									
								INDEX	N1-121001								
1/8 - 40	3,18	40	0,635	20 x 5	3	3,09	7123	●									
3/16 - 24	4,76	24	1,058	20 x 7	4	4,66	7125	●									
1/4 - 20	6,35	20	1,270	20 x 7	4	6,24	7127	●									
5/16 - 18	7,94	18	1,411	25 x 9	4	7,82	7128	●									
3/8 - 16	9,53	16	1,588	30 x 11	4	9,40	7129	●									
7/16 - 14	11,11	14	1,814	30 x 11	4	10,98	7130	●									
1/2 - 12	12,7	12	2,117	38 x 14	4	12,56	7131	●									
9/16 - 12	14,29	12	2,117	38 x 14	4	14,14	7132	●									
5/8 - 11	15,88	11	2,309	45 x 18	5	15,72	7133	●									
3/4 - 10	19,05	10	2,540	45 x 18	5	18,89	7135	●									
7/8 - 9	22,23	9	2,822	55 x 22	5	22,10	7137	●									
1 - 8	25,4	8	3,175	55 x 22	5	25,27	7139	●									



British Whitworth fine thread BSF,
BS-84:2007

800

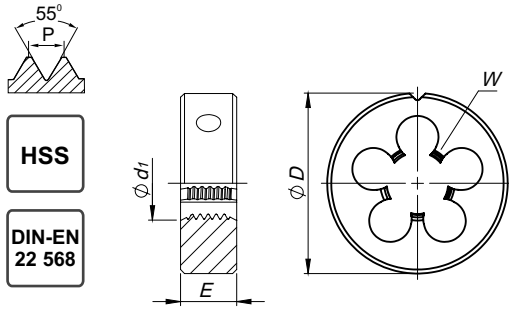

Material groups



Execution

Quality of material

HSS

Chamfer

1,75P

5

BSF	Ød ₁	1"/P	P	ØD x E	W		Norm	Tol.	INDEX
							DIN-EN 22 568		
3/16 - 32	4,76	32	0,794	20 x 7	4	4,76	7225	medium	N1-121001
1/4 - 26	6,35	26	0,977	20 x 7	4	6,25	7227	•	
5/16 - 22	7,94	22	1,155	25 x 9	4	7,83	7228	•	
3/8 - 20	9,53	20	1,270	30 x 11	4	9,41	7229	•	
7/16 - 18	11,11	18	1,411	30 x 11	5	10,99	7230	•	
1/2 - 16	12,70	16	1,588	38 x 10	5	12,57	7231	•	
9/16 - 16	14,29	16	1,588	38 x 10	4	14,16	7232	•	
5/8 - 14	15,88	14	1,814	45 x 14	4	15,73	7233	•	
3/4 - 12	19,05	12	2,117	45 x 14	5	18,89	7235	•	
7/8 - 11	22,23	11	2,309	55 x 22	5	22,11	7237	•	
1 - 10	25,40	10	2,540	55 x 22	5	25,28	7239	•	

American tapered pipe thread NPT 1:16, ANSI B-1.20.1								800										
Material groups								<table border="1"> <tr><td>P</td><td>M</td><td>K</td></tr> <tr><td>N</td><td>S</td><td>H</td></tr> </table>		P	M	K	N	S	H			
P	M	K																
N	S	H																
Execution																		
Quality of material								HSS										
Chamfer								2P										
NPT	Ød ₁	1"/P	P	ØD x E	W		Norm											
							Tol.											
							INDEX											
1/8	9,728	27	0,941	30 x 11	5	9,99	4623	●										
1/4	13,157	18	1,411	38 x 14	5	13,26	4627	●										
3/8	16,662	18	1,411	45 x 18	5	16,67	4629	●										
1/2	20,955	14	1,814	45 x 18	6	20,71	4631	●										
3/4	26,441	14	1,814	55 x 22	6	26,03	4635	●										
1	33,249	11.1/2	2,209	65 x 25	7	32,59	4639	●										





DRILLING TOOLS

SELECTION TABLE

7 - 8

CATALOGUE PAGES

141 - 178

DIN-6537	Solid carbide twist drills	3xD	MASTERDRILL X-DRILL	141 - 143
	Solid carbide twist drills	5xD	MASTERDRILL X-DRILL	144 - 146
	Solid carbide twist drills	8xD	MASTERDRILL	147 - 149
	Solid carbide twist drills for hardened materials	3xD	HRC	150 - 152
	Solid carbide twist drills for hardened materials	5xD	HRC	153 - 155
	Solid carbide twist drills for non-ferrous materials	5xD	AL	156 - 158
DIN-6539	Solid carbide micro twist drills		X-DRILL	159
	Solid carbide drills with cutting chamfer		X-DRILL	160 - 161
DIN-338	Twist drills		INOX	162 - 164
	HSS multistage drills		WST	165
	Drills to remove broken taps		WDG	166
	NC Spotting drills			167
DIN-333 A / B / R / EL	A, B, R and EL center drills			168 - 171
	Chamfering tools			172
	Two-sided chamfering tools for CNC machines			173
DIN-335-C	Countersinks with cylindrical shank			174
DIN-335-D	Countersinks with Morse taper			175
	Countersinks with inserts		PF	176
DIN-373	Counterbores			177
	Taper reamers 1:16			178

3xD Maximal hole depth

MASTERDRILL

X-DRILL

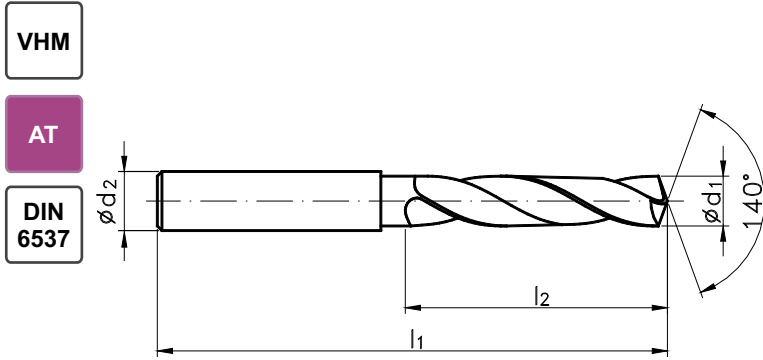

- VHM
- AT
- DIN 6537



Material groups



Internal cooling

IK

-

Quality of material

VHM

VHM

Coating

AT

AT

Ød ₁	M MF	M "WGN"	l ₁	l ₂	Ød ₂ h6	Norm	DIN-6537	
						Tol.	m7	m7
						INDEX	W9-604M33	W9-604X13
3,00			62	20	6,0	0300	●	●
3,10			62	20	6,0	0310	○	○
3,20			62	20	6,0	0320	●	●
3,25		M3,5	62	20	6,0	0325	○	○
3,30	M4		62	20	6,0	0330	●	●
3,40			62	20	6,0	0340	○	○
3,50	M4x0,5		62	20	6,0	0350	○	●
3,60			62	20	6,0	0360	○	○
3,70	M4,5	M4	62	20	6,0	0370	●	●
3,80			66	24	6,0	0380	●	●
3,90			66	24	6,0	0390	○	○
4,00			66	24	6,0	0400	●	●
4,10			66	24	6,0	0410	○	○
4,20	M5	M4,5	66	24	6,0	0420	●	●
4,30			66	24	6,0	0430	●	●
4,40			66	24	6,0	0440	○	●
4,50	M5x0,5		66	24	6,0	0450	●	●
4,60	M5,5		66	24	6,0	0460	○	○
4,65		M5	66	24	6,0	0465	○	○
4,70			66	24	6,0	0470	○	○
4,80			66	28	6,0	0480	○	○
4,90			66	28	6,0	0490	○	○
5,00	M6		66	28	6,0	0500	●	●
5,10		M5,5	66	28	6,0	0510	○	●
5,20	M6x0,75		66	28	6,0	0520	●	●
5,30			66	28	6,0	0530	○	○
5,40			66	28	6,0	0540	○	○
5,50			66	28	6,0	0550	●	●
5,60		M6	66	28	6,0	0560	○	○
5,70			66	28	6,0	0570	○	○
5,80			66	28	6,0	0580	○	○
5,90			66	28	6,0	0590	○	○
6,00	M7		66	28	6,0	0600	●	●
6,10			79	34	8,0	0610	○	○
6,20	M7x0,75		79	34	8,0	0620	○	○
6,30			79	34	8,0	0630	○	○
6,40			79	34	8,0	0640	○	○
6,50			79	34	8,0	0650	●	●
6,60		M7	79	34	8,0	0660	○	○
6,70			79	34	8,0	0670	○	○
6,80	M8		79	34	8,0	0680	●	●
6,90			79	34	8,0	0690	○	○
7,00	M8x1		79	34	8,0	0700	●	●
7,10			79	41	8,0	0710	○	○
7,20	M8x0,75		79	41	8,0	0720	○	○
7,30			79	41	8,0	0730	○	○



3xD Maximal hole depth

MASTERDRILL

X-DRILL

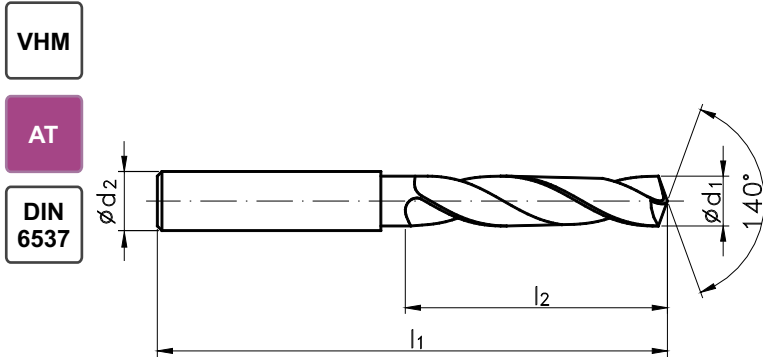

- VHM
- AT
- DIN 6537



Material groups



Internal cooling

IK

-

Quality of material

VHM

VHM

Coating

AT

AT

6

Ø d ₁	M MF	M "WGN"	l ₁	l ₂	Ø d ₂ h6	Norm	DIN-6537	
						Tol.	m7	m7
						INDEX	W9-604M33	W9-604X13
7,40			79	41	8,0	0740	○	○
7,45		M8	79	41	8,0	0745	●	○
7,50			79	41	8,0	0750	○	●
7,60		M8x1	79	41	8,0	0760	●	○
7,70			79	41	8,0	0770	○	○
7,80	M9		79	41	8,0	0780	●	○
7,90			79	41	8,0	0790	○	○
8,00	M9x1		79	41	8,0	0800	●	●
8,10			89	47	10,0	0810	○	○
8,20	M9x0,75		89	47	10,0	0820	○	○
8,30			89	47	10,0	0830	○	○
8,40			89	47	10,0	0840	○	○
8,45		M9	89	47	10,0	0845	○	○
8,50	M10		89	47	10,0	0850	●	●
8,60		M9x1	89	47	10,0	0860	○	○
8,70		M9x0,75	89	47	10,0	0870	○	○
8,80	M10x1,25		89	47	10,0	0880	○	○
8,90			89	47	10,0	0890	○	○
9,00	M10x1		89	47	10,0	0900	●	●
9,10			89	47	10,0	0910	○	○
9,20	M10x0,75		89	47	10,0	0920	○	○
9,30			89	47	10,0	0930	○	○
9,35		M10	89	47	10,0	0935	●	●
9,40			89	47	10,0	0940	○	○
9,45		M10x1,25	89	47	10,0	0945	○	○
9,50	M11		89	47	10,0	0950	●	●
9,60		M10x1	89	47	10,0	0960	○	○
9,70		M10x0,75	89	47	10,0	0970	○	○
9,80			89	47	10,0	0980	●	●
9,90			89	47	10,0	0990	○	○
10,00	M11x1		89	47	10,0	1000	●	●
10,10			102	55	12,0	1010	○	○
10,20	M12		102	55	12,0	1020	●	●
10,30			102	55	12,0	1030	○	○
10,40			102	55	12,0	1040	○	○
10,50	M12x1,5		102	55	12,0	1050	●	●
10,60		M11x1	102	55	12,0	1060	○	○
10,70			102	55	12,0	1070	○	○
10,80	M12x1,25		102	55	12,0	1080	○	○
10,90			102	55	12,0	1090	○	○
11,00	M12x1		102	55	12,0	1100	●	●
11,10			102	55	12,0	1110	○	○
11,20			102	55	12,0	1120	○	○
11,25		M12	102	55	12,0	1125	○	○
11,30			102	55	12,0	1130	○	○
11,35		M12x1,5	102	55	12,0	1135	○	○

3xD Maximal hole depth						MASTERDRILL	X-DRILL													
<div style="display: flex; align-items: center;"> <div style="border: 1px solid black; padding: 2px; margin-right: 10px;">VHM</div> <div style="border: 1px solid black; padding: 2px; margin-right: 10px; background-color: #800040; color: white;">AT</div> <div style="border: 1px solid black; padding: 2px; margin-right: 10px;">DIN 6537</div> </div>																				
Material groups						<table border="1" style="font-size: small;"> <tr><td>P</td><td>M</td><td>K</td></tr> <tr><td>N</td><td>S</td><td>H</td></tr> </table>	P	M	K	N	S	H	<table border="1" style="font-size: small;"> <tr><td>P</td><td>M</td><td>K</td></tr> <tr><td>N</td><td>S</td><td>H</td></tr> </table>	P	M	K	N	S	H	
P	M	K																		
N	S	H																		
P	M	K																		
N	S	H																		
Internal cooling						IK	-													
Quality of material						VHM	VHM													
Coating						AT	AT													
$\varnothing d_1$	M MF	M "WGN"	l_1	l_2	$\varnothing d_2 h_6$	DIN-6537														
						Norm	m7													
						Tol.	W9-604M33	W9-604X13												
						INDEX														
11,40			102	55	12,0	1140	o	o												
11,45		M12x1,25	102	55	12,0	1145	o	o												
11,50			102	55	12,0	1150	●	●												
11,60		M12x1	102	55	12,0	1160	o	o												
11,70			102	55	12,0	1170	o	o												
11,80			102	55	12,0	1180	●	●												
11,90			102	55	12,0	1190	o	o												
12,00	M14		102	55	12,0	1200	●	●												
12,30			107	60	14,0	1230	o	o												
12,50	M14x1,5		107	60	14,0	1250	●	●												
12,80	M14x1,25		107	60	14,0	1280	o	o												
13,00	M14x1	M14	107	60	14,0	1300	●	●												
13,50			107	60	14,0	1350	●	●												
13,80			107	60	14,0	1380	o	o												
14,00	M16; M15x1		107	60	14,0	1400	●	●												
14,50	M16x1,5		115	65	16,0	1450	●	●												
14,80			115	65	16,0	1480	o	o												
15,00	M16x1	M16	115	65	16,0	1500	●	●												
15,35		M16x1,5	115	65	16,0	1535	o	o												
15,50	M18		115	65	16,0	1550	o	o												
15,80			115	65	16,0	1580	●	●												
16,00	M18x2		115	65	16,0	1600	●	●												
16,50	M18x1,5		123	73	18,0	1650	o	o												
16,80		M18	123	73	18,0	1680	o	o												
17,00	M18x1		123	73	18,0	1700	●	●												
17,35		M18x1,5	123	73	18,0	1735	o	o												
17,50	M20		123	73	18,0	1750	o	o												
17,80			123	73	18,0	1780	o	o												
18,00	M20x2		123	73	18,0	1800	●	●												
18,50	M20x1,5		131	79	20,0	1850	o	o												
18,80		M20	131	79	20,0	1880	o	o												
19,00	M20x1		131	79	20,0	1900	o	o												
19,35		M20x1,5	131	79	20,0	1935	o	o												
19,50	M22		131	79	20,0	1950	o	o												
19,80			131	79	20,0	1980	o	o												
20,00	M22x2		131	79	20,0	2000	o	o												



5xD Maximal hole depth

MASTERDRILL

X-DRILL

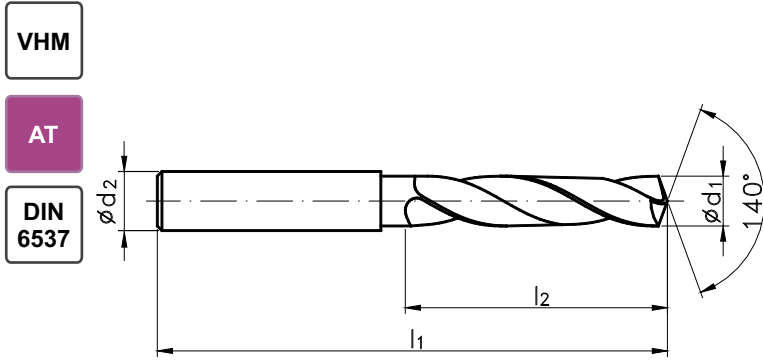

- VHM
- AT
- DIN 6537



Material groups	P M K N S H	P M K N S H
Internal cooling	IK	-
Quality of material	VHM	VHM
Coating	AT	AT

6

Ø d ₁	M MF	M "WGN"	l ₁	l ₂	Ø d ₂ h6	DIN-6537		
						Norm	m7	
						Tol.	W9-614M33	W9-614X13
3,00			66	28	6,0	0300	●	●
3,10			66	28	6,0	0310	○	●
3,20			66	28	6,0	0320	●	●
3,25		M3,5	66	28	6,0	0325	○	●
3,30	M4		66	28	6,0	0330	●	●
3,40			66	28	6,0	0340	○	○
3,50	M4x0,5		66	28	6,0	0350	○	●
3,60			66	28	6,0	0360	○	●
3,70	M4,5	M4	66	28	6,0	0370	●	●
3,80			74	36	6,0	0380	●	●
3,90			74	36	6,0	0390	○	○
4,00			74	36	6,0	0400	●	●
4,10			74	36	6,0	0410	○	○
4,20	M5	M4,5	74	36	6,0	0420	●	●
4,30			74	36	6,0	0430	●	●
4,40			74	36	6,0	0440	○	○
4,50	M5x0,5		74	36	6,0	0450	●	●
4,60	M5,5		74	36	6,0	0460	○	○
4,65		M5	74	36	6,0	0465	○	○
4,70			74	36	6,0	0470	○	○
4,80			82	44	6,0	0480	○	○
4,90			82	44	6,0	0490	○	○
5,00	M6		82	44	6,0	0500	●	●
5,10		M5,5	82	44	6,0	0510	○	○
5,20	M6x0,75		82	44	6,0	0520	●	●
5,30			82	44	6,0	0530	○	○
5,40			82	44	6,0	0540	○	○
5,50			82	44	6,0	0550	●	●
5,60		M6	82	44	6,0	0560	●	●
5,70			82	44	6,0	0570	○	○
5,80			82	44	6,0	0580	○	○
5,90			82	44	6,0	0590	○	○
6,00	M7		82	44	6,0	0600	●	●
6,10			91	53	8,0	0610	○	○
6,20	M7x0,75		91	53	8,0	0620	○	○
6,30			91	53	8,0	0630	○	○
6,40			91	53	8,0	0640	○	○
6,50			91	53	8,0	0650	●	●
6,60		M7	91	53	8,0	0660	○	○
6,70			91	53	8,0	0670	○	○
6,80	M8		91	53	8,0	0680	●	●
6,90			91	53	8,0	0690	○	○
7,00	M8x1		91	53	8,0	0700	●	●
7,10			91	53	8,0	0710	○	○
7,20	M8x0,75		91	53	8,0	0720	○	○
7,30			91	53	8,0	0730	○	○

5xD Maximal hole depth

MASTERDRILL

X-DRILL

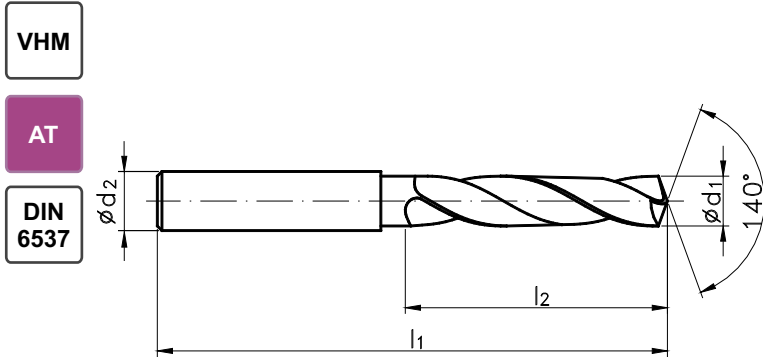

- VHM
- AT
- DIN 6537



Material groups	P M K N S H	P M K N S H
Internal cooling	IK	-
Quality of material	VHM	VHM
Coating	AT	AT

Ø d ₁	M MF	M "WGN"	l ₁	l ₂	Ø d ₂ h6	Norm	DIN-6537	
						Tol.	m7	m7
						INDEX	W9-614M33	W9-614X13
7,40			91	53	8,0	0740	○	○
7,45		M8	91	53	8,0	0745	●	●
7,50			91	53	8,0	0750	○	○
7,60		M8x1	91	53	8,0	0760	●	●
7,70			91	53	8,0	0770	○	○
7,80	M9		91	53	8,0	0780	●	●
7,90			91	53	8,0	0790	○	○
8,00	M9x1		91	53	8,0	0800	●	●
8,10			103	61	10,0	0810	○	○
8,20	M9x0,75		103	61	10,0	0820	○	○
8,30			103	61	10,0	0830	○	○
8,40			103	61	10,0	0840	○	○
8,45		M9	103	61	10,0	0845	○	○
8,50	M10		103	61	10,0	0850	●	●
8,60		M9x1	103	61	10,0	0860	○	○
8,70		M9x0,75	103	61	10,0	0870	○	○
8,80	M10x1,25		103	61	10,0	0880	○	○
8,90			103	61	10,0	0890	○	○
9,00	M10x1		103	61	10,0	0900	●	●
9,10			103	61	10,0	0910	○	○
9,20	M10x0,75		103	61	10,0	0920	○	○
9,30			103	61	10,0	0930	○	○
9,35		M10	103	61	10,0	0935	●	●
9,40			103	61	10,0	0940	○	○
9,45		M10x1,25	103	61	10,0	0945	○	○
9,50	M11		103	61	10,0	0950	●	●
9,60		M10x1	103	61	10,0	0960	○	○
9,70		M10x0,75	103	61	10,0	0970	○	○
9,80			103	61	10,0	0980	●	●
9,90			103	61	10,0	0990	○	○
10,00	M11x1		103	61	10,0	1000	●	●
10,10			118	71	12,0	1010	○	○
10,20	M12		118	71	12,0	1020	●	●
10,30			118	71	12,0	1030	○	○
10,40			118	71	12,0	1040	○	○
10,50	M12x1,5		118	71	12,0	1050	●	●
10,60		M11x1	118	71	12,0	1060	○	○
10,70			118	71	12,0	1070	○	○
10,80	M12x1,25		118	71	12,0	1080	○	○
10,90			118	71	12,0	1090	○	○
11,00	M12x1		118	71	12,0	1100	●	●
11,10			118	71	12,0	1110	○	○
11,20			118	71	12,0	1120	○	○
11,25		M12	118	71	12,0	1125	○	○
11,30			118	71	12,0	1130	○	○
11,35		M12,1,5	118	71	12,0	1135	○	○



5xD Maximal hole depth

MASTERDRILL

X-DRILL

VHM

AT

DIN 6537

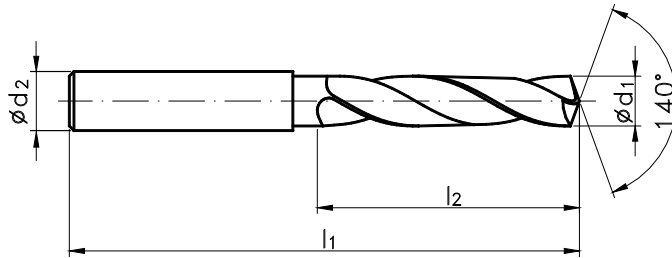

Material groups



Internal cooling

IK

-

Quality of material

VHM

VHM

Coating

AT

AT

Ø d ₁	M MF	M "WGN"	l ₁	l ₂	Ø d ₂ h6	Norm	DIN-6537	
						Tol.	m7	m7
						INDEX	W9-614M33	W9-614X13
11,40			118	71	12,0	1140	o	o
11,45		M12x1,25	118	71	12,0	1145	o	o
11,50			118	71	12,0	1150	●	●
11,60		M12x1	118	71	12,0	1160	o	o
11,70			118	71	12,0	1170	o	o
11,80			118	71	12,0	1180	●	●
11,90			118	71	12,0	1190	o	o
12,00	M14		118	71	12,0	1200	●	●
12,30			124	77	14,0	1230	o	o
12,50	M14x1,5		124	77	14,0	1250	●	●
12,80	M14x1,25		124	77	14,0	1280	o	o
13,00	M14x1	M14	124	77	14,0	1300	●	●
13,50			124	77	14,0	1350	●	●
13,80			124	77	14,0	1380	o	o
14,00	M16; M15x1		124	77	14,0	1400	●	●
14,50	M16x1,5		133	83	16,0	1450	●	●
14,80			133	83	16,0	1480	o	o
15,00	M16x1	M16	133	83	16,0	1500	●	●
15,35		M16x1,5	133	83	16,0	1535	o	o
15,50	M18		133	83	16,0	1550	o	o
15,80			133	83	16,0	1580	●	●
16,00	M18x2		133	83	16,0	1600	●	●
16,50	M18x1,5		143	93	18,0	1650	o	o
16,80		M18	143	93	18,0	1680	o	o
17,00	M18x1		143	93	18,0	1700	●	●
17,35		M18x1,5	143	93	18,0	1735	o	o
17,50	M20		143	93	18,0	1750	o	o
17,80			143	93	18,0	1780	o	o
18,00	M20x2		143	93	18,0	1800	●	●
18,50	M20x1,5		153	101	20,0	1850	o	o
18,80		M20	153	101	20,0	1880	o	o
19,00	M20x1		153	101	20,0	1900	o	o
19,35		M20x1,5	153	101	20,0	1935	o	o
19,50	M22		153	101	20,0	1950	o	o
19,80			153	101	20,0	1980	o	o
20,00	M22x2		153	101	20,0	2000	o	o

8xD Maximal hole depth

4_{lysinki}

MASTERDRILL

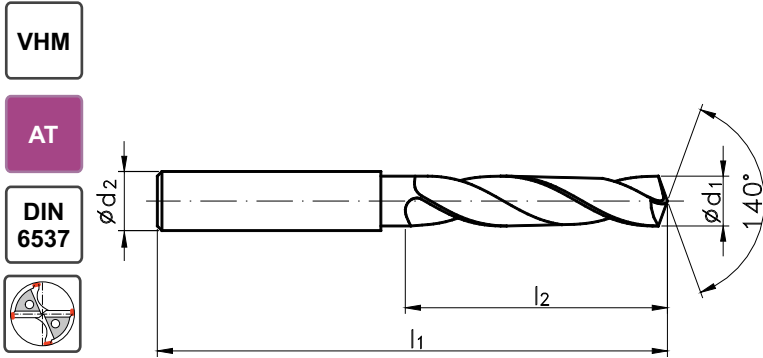

- VHM
- AT
- DIN 6537

Material groups



Internal cooling

IK

Quality of material

VHM

Coating

AT

Ø d ₁	M MF	M "WGN"	l ₁	l ₂	Ø d ₂ h6	Norm	DIN-6537		
						Tol.	m7		
						INDEX	W9-624063		
3,00			72	34	6,0	0300	o		
3,10			72	34	6,0	0310	o		
3,20			72	34	6,0	0320	o		
3,30	M4		72	34	6,0	0330	o		
3,40			72	34	6,0	0340	o		
3,50	M4x0,5		72	34	6,0	0350	o		
3,60			72	34	6,0	0360	o		
3,70	M4,5	M4	72	34	6,0	0370	o		
3,80	M4x0,5		81	43	6,0	0380	o		
3,90			81	43	6,0	0390	o		
4,00			81	43	6,0	0400	o		
4,10			81	43	6,0	0410	o		
4,20	M5	M4,5	81	43	6,0	0420	o		
4,30			81	43	6,0	0430	o		
4,40			81	43	6,0	0440	o		
4,50	M5x0,5		81	43	6,0	0450	o		
4,60	M5,5		81	43	6,0	0460	o		
4,70			81	43	6,0	0470	o		
4,80	M5x0,5		95	57	6,0	0480	o		
4,90			95	57	6,0	0490	o		
5,00	M6		95	57	6,0	0500	o		
5,10		M5,5	95	57	6,0	0510	o		
5,20	M6x0,75		95	57	6,0	0520	o		
5,30			95	57	6,0	0530	o		
5,40			95	57	6,0	0540	o		
5,50			95	57	6,0	0550	o		
5,60		M6	95	57	6,0	0560	o		
5,70	M6x0,75		95	57	6,0	0570	o		
5,80	M6x0,5		95	57	6,0	0580	o		
5,90			95	57	6,0	0590	o		
6,00	M7		95	57	6,0	0600	o		
6,10			114	76	8,0	0610	o		
6,20	M7x0,75		114	76	8,0	0620	o		
6,30			114	76	8,0	0630	o		
6,40			114	76	8,0	0640	o		
6,50			114	76	8,0	0650	o		
6,60		M7	114	76	8,0	0660	o		
6,70	M7x0,75		114	76	8,0	0670	o		
6,80	M8		114	76	8,0	0680	o		
6,90			114	76	8,0	0690	o		
7,00	M8x1		114	76	8,0	0700	o		
7,10			114	76	8,0	0710	o		
7,20	M8x0,75		114	76	8,0	0720	o		
7,30			114	76	8,0	0730	o		
7,40			114	76	8,0	0740	o		
7,50			114	76	8,0	0750	o		



8xD Maximal hole depth

4_{lysinki}

MASTERDRILL

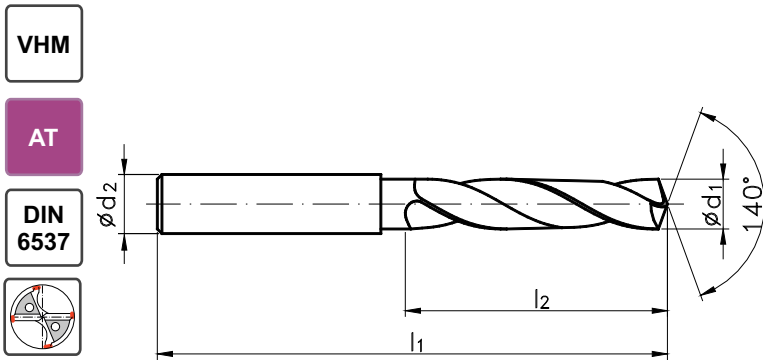

- VHM
- AT
- DIN 6537



Material groups

Internal cooling

IK

Quality of material

VHM

Coating

AT

Ø d ₁	M MF	M "WGN"	l ₁	l ₂	Ød ₂ h6	Norm	DIN-6537			
						Tol.	m7			
						INDEX	W9-624063			
7,60	M8x1		114	76	8,0	0760	o			
7,70	M8x0,75		114	76	8,0	0770	o			
7,80	M9		114	76	8,0	0780	o			
7,90			114	76	8,0	0790	o			
8,00	M9x1		114	76	8,0	0800	o			
8,10			142	95	10,0	0810	o			
8,20	M9x0,75		142	95	10,0	0820	o			
8,30			142	95	10,0	0830	o			
8,40			142	95	10,0	0840	o			
8,50	M10		142	95	10,0	0850	o			
8,60		M9x1	142	95	10,0	0860	o			
8,70		M9x0,75	142	95	10,0	0870	o			
8,80	M10x1,25		142	95	10,0	0880	o			
8,90			142	95	10,0	0890	o			
9,00	M10x1		142	95	10,0	0900	o			
9,10			142	95	10,0	0910	o			
9,20	M10x0,75		142	95	10,0	0920	o			
9,30			142	95	10,0	0930	o			
9,40			142	95	10,0	0940	o			
9,50	M11		142	95	10,0	0950	o			
9,60		M10x1	142	95	10,0	0960	o			
9,70		M10x0,75	142	95	10,0	0970	o			
9,80			142	95	10,0	0980	o			
9,90			142	95	10,0	0990	o			
10,00	M11x1		142	95	10,0	1000	o			
10,10			162	114	12,0	1010	o			
10,20	M12		162	114	12,0	1020	o			
10,30			162	114	12,0	1030	o			
10,40			162	114	12,0	1040	o			
10,50	M12x1,5		162	114	12,0	1050	o			
10,60		M11x1	162	114	12,0	1060	o			
10,70			162	114	12,0	1070	o			
10,80	M12x1,25		162	114	12,0	1080	o			
10,90			162	114	12,0	1090	o			
11,00	M12x1		162	114	12,0	1100	o			
11,10			162	114	12,0	1110	o			
11,20			162	114	12,0	1120	o			
11,30			162	114	12,0	1130	o			
11,40			162	114	12,0	1140	o			
11,50			162	114	12,0	1150	o			
11,60		M12x1	162	114	12,0	1160	o			
11,70			162	114	12,0	1170	o			
11,80			162	114	12,0	1180	o			
11,90			162	114	12,0	1190	o			
12,00	M14		162	114	12,0	1200	o			
12,30			178	133	14,0	1230	o			

8xD Maximal hole depth

4^{lysinki}

MASTERDRILL

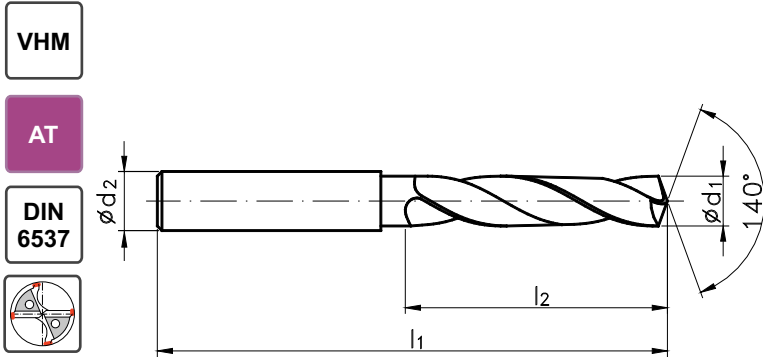

- VHM
- AT
- DIN 6537

Material groups



Internal cooling

IK

Quality of material

VHM

Coating

AT

Ø d ₁	M MF	M "WGN"	l ₁	l ₂	Ø d ₂ h6	Norm			
						DIN-6537			
						Tol.	m7		
						INDEX	W9-624063		
12,50	M14x1,5		178	133	14,0	1250	o		
12,80			178	133	14,0	1280	o		
13,00	M14x1		178	133	14,0	1300	o		
13,50			178	133	14,0	1350	o		
13,80			178	133	14,0	1380	o		
14,00	M16, M15x1		178	133	14,0	1400	o		
14,50	M16x1,5		203	152	16,0	1450	o		
14,80			203	152	16,0	1480	o		
15,00	M16x1		203	152	16,0	1500	o		
15,50	M18		203	152	16,0	1550	o		
15,80			203	152	16,0	1580	o		
16,00	M18x2		203	152	16,0	1600	o		
16,50	M18x1,5		222	171	18,0	1650	o		
16,80			222	171	18,0	1680	o		
17,00	M18x1		222	171	18,0	1700	o		
17,50	M20		222	171	18,0	1750	o		
17,80			222	171	18,0	1780	o		
18,00	M20x2		222	171	18,0	1800	o		
18,50	M20x1,5		243	190	20,0	1850	o		
19,00	M20x1		243	190	20,0	1900	o		
19,50	M22		243	190	20,0	1950	o		
19,80			243	190	20,0	1980	o		
20,00	M22x2		243	190	20,0	2000	o		



3xD Maximal hole depth

4 lysinki

HRC

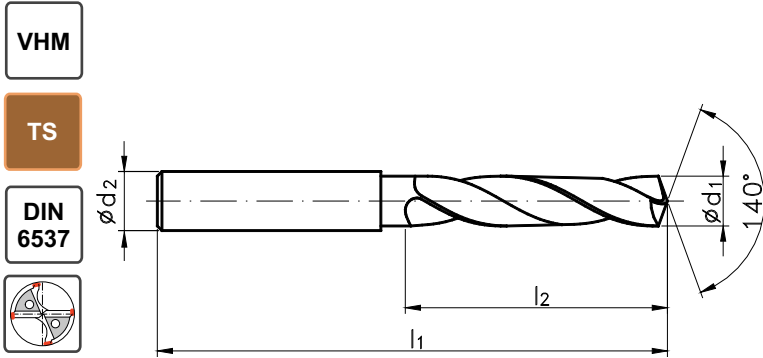

- VHM**
- TS**
- DIN 6537**

Material groups



Internal cooling

IK

Quality of material

VHM

Coating

TS

6

Ø d ₁	M MF	M "WGN"	l ₁	l ₂	Ø d ₂ h6	Norm	DIN-6537	
						Tol.	m7	
						INDEX	W9-60G963	
3,00			62	20	6,0	0300	o	
3,10			62	20	6,0	0310	o	
3,20			62	20	6,0	0320	o	
3,25		M3,5	62	20	6,0	0325	o	
3,30	M4		62	20	6,0	0330	o	
3,40			62	20	6,0	0340	o	
3,50	M4x0,5		62	20	6,0	0350	o	
3,60			62	20	6,0	0360	o	
3,70	M4,5	M4	62	20	6,0	0370	o	
3,80			66	24	6,0	0380	o	
3,90			66	24	6,0	0390	o	
4,00			66	24	6,0	0400	o	
4,10			66	24	6,0	0410	o	
4,20	M5	M4,5	66	24	6,0	0420	o	
4,30			66	24	6,0	0430	o	
4,40			66	24	6,0	0440	o	
4,50	M5x0,5		66	24	6,0	0450	o	
4,60	M5,5		66	24	6,0	0460	o	
4,65		M5	66	24	6,0	0465	o	
4,70			66	24	6,0	0470	o	
4,80			66	28	6,0	0480	o	
4,90			66	28	6,0	0490	o	
5,00	M6		66	28	6,0	0500	o	
5,10		M5,5	66	28	6,0	0510	o	
5,20	M6x0,75		66	28	6,0	0520	o	
5,30			66	28	6,0	0530	o	
5,40			66	28	6,0	0540	o	
5,50			66	28	6,0	0550	o	
5,60		M6	66	28	6,0	0560	o	
5,70			66	28	6,0	0570	o	
5,80			66	28	6,0	0580	o	
5,90			66	28	6,0	0590	o	
6,00	M7		66	28	6,0	0600	o	
6,10			79	34	8,0	0610	o	
6,20	M7x0,75		79	34	8,0	0620	o	
6,30			79	34	8,0	0630	o	
6,40			79	34	8,0	0640	o	
6,50			79	34	8,0	0650	o	
6,60		M7	79	34	8,0	0660	o	
6,70			79	34	8,0	0670	o	
6,80	M8		79	34	8,0	0680	o	
6,90			79	34	8,0	0690	o	
7,00	M8x1		79	34	8,0	0700	o	
7,10			79	41	8,0	0710	o	
7,20	M8x0,75		79	41	8,0	0720	o	
7,30			79	41	8,0	0730	o	

3xD Maximal hole depth

4 lysinki

HRC

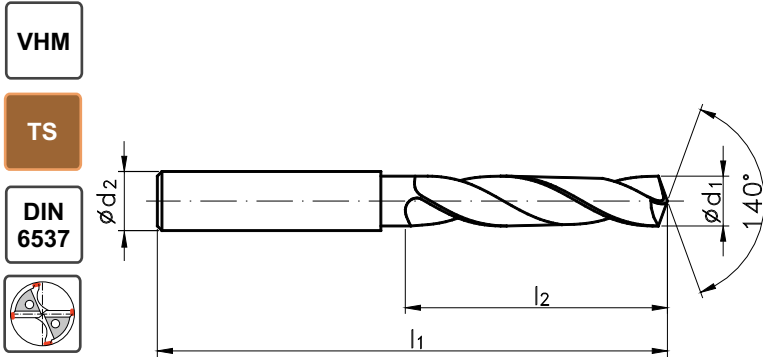

- VHM**
- TS**
- DIN 6537**

Material groups



Internal cooling

IK

Quality of material

VHM

Coating

TS

Ø d ₁	M MF	M "WGN"	l ₁	l ₂	Ø d ₂ h6	Norm	
						DIN-6537	
						Tol.	m7
						INDEX	W9-60G963
7,40			79	41	8,0	0740	o
7,45		M8	79	41	8,0	0745	o
7,50			79	41	8,0	0750	o
7,60		M8x1	79	41	8,0	0760	o
7,70			79	41	8,0	0770	o
7,80	M9		79	41	8,0	0780	o
7,90			79	41	8,0	0790	o
8,00	M9x1		79	41	8,0	0800	o
8,10			89	47	10,0	0810	o
8,20	M9x0,75		89	47	10,0	0820	o
8,30			89	47	10,0	0830	o
8,40			89	47	10,0	0840	o
8,45		M9	89	47	10,0	0845	o
8,50	M10		89	47	10,0	0850	o
8,60		M9x1	89	47	10,0	0860	o
8,70		M9x0,75	89	47	10,0	0870	o
8,80	M10x1,25		89	47	10,0	0880	o
8,90			89	47	10,0	0890	o
9,00	M10x1		89	47	10,0	0900	o
9,10			89	47	10,0	0910	o
9,20	M10x0,75		89	47	10,0	0920	o
9,30			89	47	10,0	0930	o
9,35		M10	89	47	10,0	0935	o
9,40			89	47	10,0	0940	o
9,45		M10x1,25	89	47	10,0	0945	o
9,50	M11		89	47	10,0	0950	o
9,60		M10x1	89	47	10,0	0960	o
9,70		M10x0,75	89	47	10,0	0970	o
9,80			89	47	10,0	0980	o
9,90			89	47	10,0	0990	o
10,00	M11x1		89	47	10,0	1000	o
10,10			102	55	12,0	1010	o
10,20	M12		102	55	12,0	1020	o
10,30			102	55	12,0	1030	o
10,40			102	55	12,0	1040	o
10,50	M12x1,5		102	55	12,0	1050	o
10,60		M11x1	102	55	12,0	1060	o
10,70			102	55	12,0	1070	o
10,80	M12x1,25		102	55	12,0	1080	o
10,90			102	55	12,0	1090	o
11,00	M12x1		102	55	12,0	1100	o
11,10			102	55	12,0	1110	o
11,20			102	55	12,0	1120	o
11,25		M12	102	55	12,0	1125	o
11,30			102	55	12,0	1130	o
11,35		M12x1,5	102	55	12,0	1135	o



3xD Maximal hole depth

4 lysinki

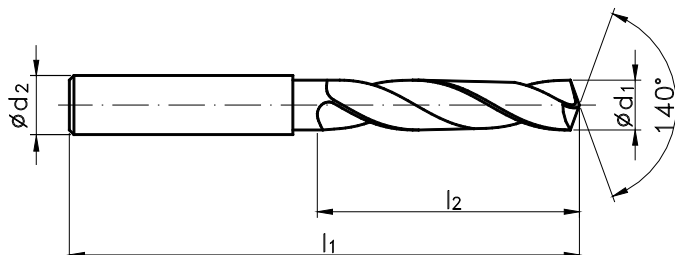
HRC
VHM
TS
DIN 6537

Material groups



Internal cooling

IK

Quality of material

VHM

Coating

TS

Ø d ₁	M MF	M "WGN"	l ₁	l ₂	Ø d ₂ h6	Norm	
						DIN-6537	
						Tol.	m7
						INDEX	W9-60G963
11,40			102	55	12,0	1140	o
11,45		M12x1,25	102	55	12,0	1145	o
11,50			102	55	12,0	1150	o
11,60		M12x1	102	55	12,0	1160	o
11,70			102	55	12,0	1170	o
11,80			102	55	12,0	1180	o
11,90			102	55	12,0	1190	o
12,00	M14		102	55	12,0	1200	o
12,30			107	60	14,0	1230	o
12,50	M14x1,5		107	60	14,0	1250	o
12,80	M14x1,25		107	60	14,0	1280	o
13,00	M14x1	M14	107	60	14,0	1300	o
13,50			107	60	14,0	1350	o
13,80			107	60	14,0	1380	o
14,00	M16; M15x1		107	60	14,0	1400	o
14,50	M16x1,5		115	65	16,0	1450	o
14,80			115	65	16,0	1480	o
15,00	M16x1	M16	115	65	16,0	1500	o
15,35		M16x1,5	115	65	16,0	1535	o
15,50	M18		115	65	16,0	1550	o
15,80			115	65	16,0	1580	o
16,00	M18x2		115	65	16,0	1600	o
16,50	M18x1,5		123	73	18,0	1650	o
16,80		M18	123	73	18,0	1680	o
17,00	M18x1		123	73	18,0	1700	o
17,35		M18x1,5	123	73	18,0	1735	o
17,50	M20		123	73	18,0	1750	o
17,80			123	73	18,0	1780	o
18,00	M20x2		123	73	18,0	1800	o
18,50	M20x1,5		131	79	20,0	1850	o
18,80		M20	131	79	20,0	1880	o
19,00	M20x1		131	79	20,0	1900	o
19,35		M20x1,5	131	79	20,0	1935	o
19,50	M22		131	79	20,0	1950	o
19,80			131	79	20,0	1980	o
20,00	M22x2		131	79	20,0	2000	o

5xD Maximal hole depth						4 _{lysinki}	HRC		
<div style="display: flex; align-items: center;"> <div style="margin-right: 20px;"> <div style="border: 1px solid black; padding: 2px; width: 40px; text-align: center; margin-bottom: 5px;">VHM</div> <div style="background-color: #8B4513; color: white; padding: 2px; width: 40px; text-align: center; margin-bottom: 5px;">TS</div> <div style="border: 1px solid black; padding: 2px; width: 40px; text-align: center; margin-bottom: 5px;">DIN 6537</div> <div style="text-align: center;"> </div> </div> <div style="margin-right: 20px;"> </div> <div style="margin-right: 20px;"> </div> </div>									
Material groups							<div style="display: flex; flex-wrap: wrap; gap: 5px;"> <div style="border: 1px solid gray; padding: 2px;">P</div> <div style="border: 1px solid gray; padding: 2px;">M</div> <div style="border: 1px solid gray; padding: 2px;">K</div> <div style="border: 1px solid gray; padding: 2px;">N</div> <div style="border: 1px solid gray; padding: 2px;">S</div> <div style="border: 1px solid gray; padding: 2px;">H</div> </div>		
Internal cooling							IK		
Quality of material							VHM		
Coating							TS		
Ø d ₁	M MF	M "WGN"	l ₁	l ₂	Ø d ₂ h6	Norm	DIN-6537		
						Tol.	m7		
						INDEX	W9-61G963		
3,00			66	28	6,0	0300	o		
3,10			66	28	6,0	0310	o		
3,20			66	28	6,0	0320	o		
3,25		M3,5	66	28	6,0	0325	o		
3,30	M4		66	28	6,0	0330	o		
3,40			66	28	6,0	0340	o		
3,50	M4x0,5		66	28	6,0	0350	o		
3,60			66	28	6,0	0360	o		
3,70	M4,5	M4	66	28	6,0	0370	o		
3,80			74	36	6,0	0380	o		
3,90			74	36	6,0	0390	o		
4,00			74	36	6,0	0400	o		
4,10			74	36	6,0	0410	o		
4,20	M5	M4,5	74	36	6,0	0420	o		
4,30			74	36	6,0	0430	o		
4,40			74	36	6,0	0440	o		
4,50	M5x0,5		74	36	6,0	0450	o		
4,60	M5,5		74	36	6,0	0460	o		
4,65		M5	74	36	6,0	0465	o		
4,70			74	36	6,0	0470	o		
4,80			82	44	6,0	0480	o		
4,90			82	44	6,0	0490	o		
5,00	M6		82	44	6,0	0500	o		
5,10		M5,5	82	44	6,0	0510	o		
5,20	M6x0,75		82	44	6,0	0520	o		
5,30			82	44	6,0	0530	o		
5,40			82	44	6,0	0540	o		
5,50			82	44	6,0	0550	o		
5,60		M6	82	44	6,0	0560	o		
5,70			82	44	6,0	0570	o		
5,80			82	44	6,0	0580	o		
5,90			82	44	6,0	0590	o		
6,00	M7		82	44	6,0	0600	o		
6,10			91	53	8,0	0610	o		
6,20	M7x0,75		91	53	8,0	0620	o		
6,30			91	53	8,0	0630	o		
6,40			91	53	8,0	0640	o		
6,50			91	53	8,0	0650	o		
6,60		M7	91	53	8,0	0660	o		
6,70			91	53	8,0	0670	o		
6,80	M8		91	53	8,0	0680	o		
6,90			91	53	8,0	0690	o		
7,00	M8x1		91	53	8,0	0700	o		
7,10			91	53	8,0	0710	o		
7,20	M8x0,75		91	53	8,0	0720	o		
7,30			91	53	8,0	0730	o		

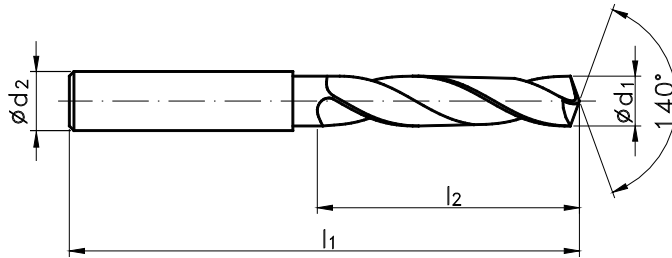

5xD Maximal hole depth
4 lysinki
HRC
VHM
TS
DIN 6537

Material groups



Internal cooling

IK

Quality of material

VHM

Coating

TS

ϕd_1	M MF	M "WGN"	l_1	l_2	ϕd_2 h6	Norm	
						DIN-6537	
						Tol.	m7
						INDEX	W9-61G963
7,40			91	53	8,0	0740	o
7,45		M8	91	53	8,0	0745	o
7,50			91	53	8,0	0750	o
7,60		M8x1	91	53	8,0	0760	o
7,70			91	53	8,0	0770	o
7,80	M9		91	53	8,0	0780	o
7,90			91	53	8,0	0790	o
8,00	M9x1		91	53	8,0	0800	o
8,10			103	61	10,0	0810	o
8,20	M9x0,75		103	61	10,0	0820	o
8,30			103	61	10,0	0830	o
8,40			103	61	10,0	0840	o
8,45		M9	103	61	10,0	0845	o
8,50	M10		103	61	10,0	0850	o
8,60		M9x1	103	61	10,0	0860	o
8,70		M9x0,75	103	61	10,0	0870	o
8,80	M10x1,25		103	61	10,0	0880	o
8,90			103	61	10,0	0890	o
9,00	M10x1		103	61	10,0	0900	o
9,10			103	61	10,0	0910	o
9,20	M10x0,75		103	61	10,0	0920	o
9,30			103	61	10,0	0930	o
9,35		M10	103	61	10,0	0935	o
9,40			103	61	10,0	0940	o
9,45		M10x1,25	103	61	10,0	0945	o
9,50	M11		103	61	10,0	0950	o
9,60		M10x1	103	61	10,0	0960	o
9,70		M10x0,75	103	61	10,0	0970	o
9,80			103	61	10,0	0980	o
9,90			103	61	10,0	0990	o
10,00	M11x1		103	61	10,0	1000	o
10,10			118	71	12,0	1010	o
10,20	M12		118	71	12,0	1020	o
10,30			118	71	12,0	1030	o
10,40			118	71	12,0	1040	o
10,50	M12x1,5		118	71	12,0	1050	o
10,60		M11x1	118	71	12,0	1060	o
10,70			118	71	12,0	1070	o
10,80	M12x1,25		118	71	12,0	1080	o
10,90			118	71	12,0	1090	o
11,00	M12x1		118	71	12,0	1100	o
11,10			118	71	12,0	1110	o
11,20			118	71	12,0	1120	o
11,25		M12	118	71	12,0	1125	o
11,30			118	71	12,0	1130	o
11,35		M12,1,5	118	71	12,0	1135	o

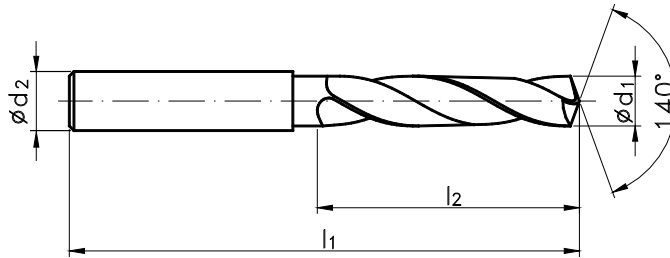
5xD Maximal hole depth
4 lysinki
HRC
VHM
TS
DIN 6537

Material groups



Internal cooling

IK

Quality of material

VHM

Coating

TS

ϕd_1	M MF	M "WGN"	l_1	l_2	ϕd_2 h6	Norm		DIN-6537	
						Tol.	INDEX	m7	
							W9-61G963		
11,40			118	71	12,0	1140	o		
11,45		M12x1,25	118	71	12,0	1145	o		
11,50			118	71	12,0	1150	o		
11,60		M12x1	118	71	12,0	1160	o		
11,70			118	71	12,0	1170	o		
11,80			118	71	12,0	1180	o		
11,90			118	71	12,0	1190	o		
12,00	M14		118	71	12,0	1200	o		
12,30			124	77	14,0	1230	o		
12,50	M14x1,5		124	77	14,0	1250	o		
12,80	M14x1,25		124	77	14,0	1280	o		
13,00	M14x1	M14	124	77	14,0	1300	o		
13,50			124	77	14,0	1350	o		
13,80			124	77	14,0	1380	o		
14,00	M16; M15x1		124	77	14,0	1400	o		
14,50	M16x1,5		133	83	16,0	1450	o		
14,80			133	83	16,0	1480	o		
15,00	M16x1	M16	133	83	16,0	1500	o		
15,35		M16x1,5	133	83	16,0	1535	o		
15,50	M18		133	83	16,0	1550	o		
15,80			133	83	16,0	1580	o		
16,00	M18x2		133	83	16,0	1600	o		
16,50	M18x1,5		143	93	18,0	1650	o		
16,80		M18	143	93	18,0	1680	o		
17,00	M18x1		143	93	18,0	1700	o		
17,35		M18x1,5	143	93	18,0	1735	o		
17,50	M20		143	93	18,0	1750	o		
17,80			143	93	18,0	1780	o		
18,00	M20x2		143	93	18,0	1800	o		
18,50	M20x1,5		153	101	20,0	1850	o		
18,80		M20	153	101	20,0	1880	o		
19,00	M20x1		153	101	20,0	1900	o		
19,35		M20x1,5	153	101	20,0	1935	o		
19,50	M22		153	101	20,0	1950	o		
19,80			153	101	20,0	1980	o		
20,00	M22x2		153	101	20,0	2000	o		

6

5xD Maximal hole depth

AL

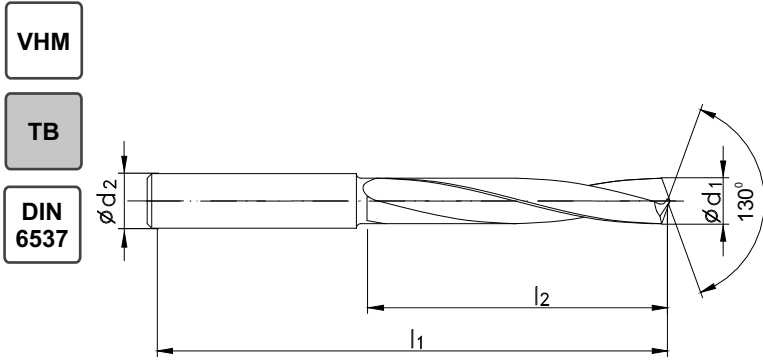

- VHM
- TB
- DIN 6537

Material groups



Internal cooling

IK IK

Quality of material

VHM VHM

Coating

- TB

Ø d ₁	M MF	M MF "WGN"	l ₁	l ₂	Ø d ₂ h6	Norm	DIN-6537	
						Tol.	m7	m7
						INDEX	W9-611733	W9-61B733
3,00			66	28	6,0	0300	o	o
3,10			66	28	6,0	0310	o	o
3,20			66	28	6,0	0320	o	o
3,25		M3,5	66	28	6,0	0325	o	o
3,30	M4		66	28	6,0	0330	o	o
3,40			66	28	6,0	0340	o	o
3,50	M4x0,5		66	28	6,0	0350	o	o
3,60			66	28	6,0	0360	o	o
3,70	M4,5	M4	66	28	6,0	0370	o	o
3,80			74	36	6,0	0380	o	o
3,90			74	36	6,0	0390	o	o
4,00			74	36	6,0	0400	o	o
4,10			74	36	6,0	0410	o	o
4,20	M5	M4,5	74	36	6,0	0420	o	o
4,30			74	36	6,0	0430	o	o
4,40			74	36	6,0	0440	o	o
4,50	M5x0,5		74	36	6,0	0450	o	o
4,60	M5,5		74	36	6,0	0460	o	o
4,65		M5	74	36	6,0	0465	o	o
4,70			74	36	6,0	0470	o	o
4,80			82	44	6,0	0480	o	o
4,90			82	44	6,0	0490	o	o
5,00	M6		82	44	6,0	0500	o	o
5,10		M5,5	82	44	6,0	0510	o	o
5,20	M6x0,75		82	44	6,0	0520	o	o
5,30			82	44	6,0	0530	o	o
5,40			82	44	6,0	0540	o	o
5,50			82	44	6,0	0550	o	o
5,60		M6	82	44	6,0	0560	o	o
5,70			82	44	6,0	0570	o	o
5,80			82	44	6,0	0580	o	o
5,90			82	44	6,0	0590	o	o
6,00	M7		82	44	6,0	0600	o	o
6,10			91	53	8,0	0610	o	o
6,20	M7x0,75		91	53	8,0	0620	o	o
6,30			91	53	8,0	0630	o	o
6,40			91	53	8,0	0640	o	o
6,50			91	53	8,0	0650	o	o
6,60		M7	91	53	8,0	0660	o	o
6,70			91	53	8,0	0670	o	o
6,80	M8		91	53	8,0	0680	o	o
6,90			91	53	8,0	0690	o	o
7,00	M8x1		91	53	8,0	0700	o	o
7,10			91	53	8,0	0710	o	o
7,20	M8x0,75		91	53	8,0	0720	o	o
7,30			91	53	8,0	0730	o	o

5xD Maximal hole depth

AL

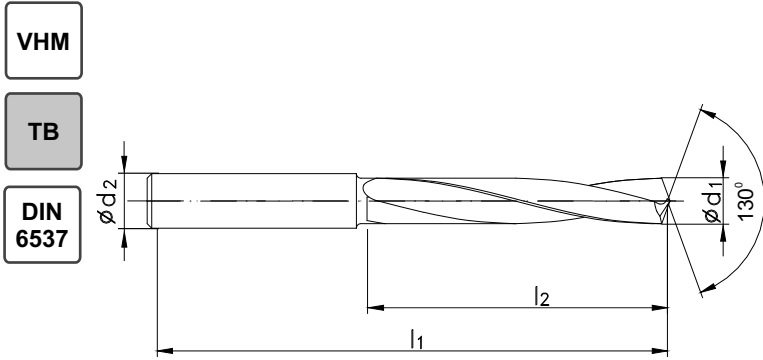

VHM

TB

DIN 6537

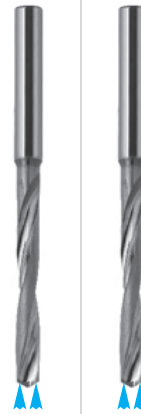

Material groups



Internal cooling

IK IK

Quality of material

VHM VHM

Coating

- TB

Ø d ₁	M MF	M MF "WGN"	l ₁	l ₂	Ø d ₂ h6	DIN-6537		
						Norm	DIN-6537	
						Tol.	m7	m7
						INDEX	W9-611733	W9-61B733
7,40			91	53	8,0	0740	o	o
7,45		M8	91	53	8,0	0745	o	o
7,50			91	53	8,0	0750	o	o
7,60		M8x1	91	53	8,0	0760	o	o
7,70			91	53	8,0	0770	o	o
7,80	M9		91	53	8,0	0780	o	o
7,90			91	53	8,0	0790	o	o
8,00	M9x1		91	53	8,0	0800	o	o
8,10			103	61	10,0	0810	o	o
8,20	M9x0,75		103	61	10,0	0820	o	o
8,30			103	61	10,0	0830	o	o
8,40			103	61	10,0	0840	o	o
8,45		M9	103	61	10,0	0845	o	o
8,50	M10		103	61	10,0	0850	o	o
8,60		M9x1	103	61	10,0	0860	o	o
8,70		M9x0,75	103	61	10,0	0870	o	o
8,80	M10x1,25		103	61	10,0	0880	o	o
8,90			103	61	10,0	0890	o	o
9,00	M10x1		103	61	10,0	0900	o	o
9,10			103	61	10,0	0910	o	o
9,20	M10x0,75		103	61	10,0	0920	o	o
9,30			103	61	10,0	0930	o	o
9,35		M10	103	61	10,0	0935	o	o
9,40			103	61	10,0	0940	o	o
9,45		M10x1,25	103	61	10,0	0945	o	o
9,50	M11		103	61	10,0	0950	o	o
9,60		M10x1	103	61	10,0	0960	o	o
9,70		M10x0,75	103	61	10,0	0970	o	o
9,80			103	61	10,0	0980	o	o
9,90			103	61	10,0	0990	o	o
10,00	M11x1		103	61	10,0	1000	o	o
10,10			118	71	12,0	1010	o	o
10,20	M12		118	71	12,0	1020	o	o
10,30			118	71	12,0	1030	o	o
10,40			118	71	12,0	1040	o	o
10,50	M12x1,5		118	71	12,0	1050	o	o
10,60		M11x1	118	71	12,0	1060	o	o
10,70			118	71	12,0	1070	o	o
10,80	M12x1,25		118	71	12,0	1080	o	o
10,90			118	71	12,0	1090	o	o
11,00	M12x1		118	71	12,0	1100	o	o
11,10			118	71	12,0	1110	o	o
11,20			118	71	12,0	1120	o	o
11,25		M12	118	71	12,0	1125	o	o
11,30			118	71	12,0	1130	o	o
11,35		M12x1,5	118	71	12,0	1135	o	o



5xD Maximal hole depth

AL

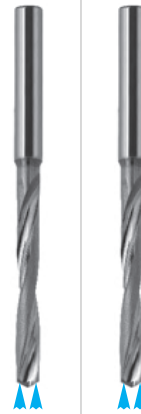
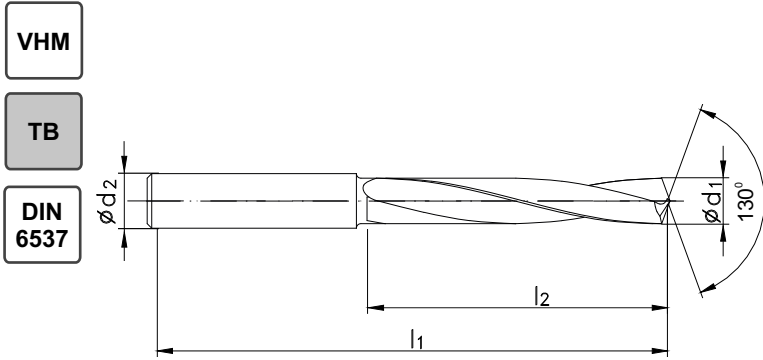

- VHM
- TB
- DIN 6537

Material groups



Internal cooling

IK IK

Quality of material

VHM VHM

Coating

- TB

Ø d ₁	M MF	M MF "WGN"	l ₁	l ₂	Ø d ₂ h6	DIN-6537		
						Norm	DIN-6537	
						Tol.	m7	m7
						INDEX	W9-611733	W9-61B733
11,40			118	71	12,0	1140	o	o
11,45		M12x1,25	118	71	12,0	1145	o	o
11,50			118	71	12,0	1150	o	o
11,60		M12x1	118	71	12,0	1160	o	o
11,70			118	71	12,0	1170	o	o
11,80			118	71	12,0	1180	o	o
11,90			118	71	12,0	1190	o	o
12,00	M14		118	71	12,0	1200	o	o
12,30			124	77	14,0	1230	o	o
12,50	M14x1,5		124	77	14,0	1250	o	o
12,80	M14x1,25		124	77	14,0	1280	o	o
13,00	M14x1	M14	124	77	14,0	1300	o	o
13,50			124	77	14,0	1350	o	o
13,80			124	77	14,0	1380	o	o
14,00	M16; M15x1		124	77	14,0	1400	o	o
14,50	M16x1,5		133	83	16,0	1450	o	o
14,80			133	83	16,0	1480	o	o
15,00	M16x1	M16	133	83	16,0	1500	o	o
15,35		M16x1,5	133	83	16,0	1535	o	o
15,50	M18		133	83	16,0	1550	o	o
15,80			133	83	16,0	1580	o	o
16,00	M18x2		133	83	16,0	1600	o	o
16,50	M18x1,5		143	93	18,0	1650	o	o
16,80		M18	143	93	18,0	1680	o	o
17,00	M18x1		143	93	18,0	1700	o	o
17,35		M18x1,5	143	93	18,0	1735	o	o
17,50	M20		143	93	18,0	1750	o	o
17,80			143	93	18,0	1780	o	o
18,00	M20x2		143	93	18,0	1800	o	o
18,50	M20x1,5		153	101	20,0	1850	o	o
18,80		M20	153	101	20,0	1880	o	o
19,00	M20x1		153	101	20,0	1900	o	o
19,35		M20x1,5	153	101	20,0	1935	o	o
19,50	M22		153	101	20,0	1950	o	o
19,80			153	101	20,0	1980	o	o
20,00	M22x2		153	101	20,0	2000	o	o

VHM

DIN 6539

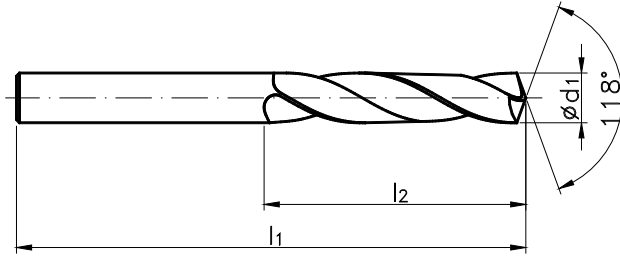

X-DRILL



Material groups



Internal cooling

-

Quality of material

VHM

Coating

-

$\varnothing d_1$	M MF	M "WGN"	l_1	l_2	Norm	DIN-6539			
					Tol.	h7			
					INDEX	W9-801014			
0,75	M1		22	6	0075	•			
0,85	M1,1		24	6	0085	•			
0,90		M1	24	7	0090	•			
0,95	M1,2		24	7	0095	•			
1,00		M1,1	26	7	0100	•			
1,10	M1,4		28	8	0110	•			
1,25	M1,6		30	9	0125	•			
1,28		M1,4	30	9	0128	•			
1,35	M1,7		30	9	0135	•			
1,45	M1,8		32	10	0145	•			
1,47		M1,6	32	10	0147	•			
1,57		M1,7	32	10	0157	•			
1,60	M2		34	11	0160	•			
1,67		M1,8	34	11	0167	•			
1,75	M2,2		34	11	0175	•			
1,85		M2	36	12	0185	•			
1,90	M2,3		36	12	0190	•			
2,00			38	12	0200	•			
2,03		M2,2	38	12	0203	•			
2,05	M2,5		38	12	0205	•			
2,10			38	12	0210	•			
2,15	M2,6	M2,3	38	12	0215	•			
2,20			40	13	0220	•			
2,30			40	13	0230	•			
2,33		M2,5	40	13	0233	•			
2,40			43	14	0240	•			
2,43		M2,6	43	14	0243	•			
2,50	M3		43	14	0250	•			
2,60			43	14	0260	•			
2,70			46	16	0270	•			
2,80		M3	46	16	0280	•			
2,90	M3,5		46	16	0290	•			



VHM

AT

DIN 6537

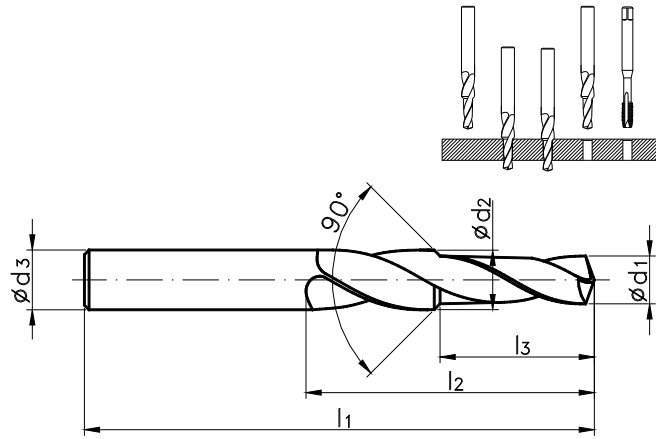

X-DRILL



Material groups



Execution

90°

Quality of material

VHM

Coating

AT

ϕd_1	M	l_1	l_2	l_3	ϕd_2	$\phi d_2 h_6$	Norm	~DIN-6537				
							Tol.					m7
							INDEX					W9-704010
2,50	M3	66	20	8,8	6	6	0250	●				
3,30	M4	66	24	11,4	6	6	0330	●				
4,20	M5	66	28	13,6	6	6	0420	●				
5,00	M6	79	34	16,5	8	8	0500	●				
6,80	M8	89	47	21,0	10	10	0680	●				
8,50	M10	102	55	25,5	12	12	0850	●				
10,20	M12	107	60	30,0	14	14	1020	●				
12,00	M14	115	65	34,5	16	16	1200	●				
14,00	M16	123	73	38,5	18	18	1400	●				

<div style="display: flex; align-items: center;"> <div style="margin-right: 20px;"> <div style="border: 1px solid black; padding: 2px; width: 40px; text-align: center;">VHM</div> <div style="border: 1px solid black; padding: 2px; width: 40px; text-align: center; background-color: #800040; color: white;">AT</div> <div style="border: 1px solid black; padding: 2px; width: 40px; text-align: center;">DIN ~6537</div> </div> <div style="text-align: center;"> </div> <div style="margin-left: 20px;"> </div> <div style="margin-left: 20px;"> </div> </div>													
Material groups													
<table border="1" style="display: inline-table; border-collapse: collapse;"> <tr> <td style="background-color: #00FFFF; width: 15px; height: 15px;">P</td> <td style="background-color: #FFFF00; width: 15px; height: 15px;">M</td> <td style="background-color: #FF0000; width: 15px; height: 15px;">K</td> </tr> <tr> <td style="background-color: #00FF00; width: 15px; height: 15px;">N</td> <td style="background-color: #0000FF; width: 15px; height: 15px;">S</td> <td style="background-color: #808080; width: 15px; height: 15px;">H</td> </tr> </table>								P	M	K	N	S	H
P	M	K											
N	S	H											
Execution													
90°													
Quality of material													
VHM													
Coating													
AT													
							Norm	~DIN-6537					
							Tol.	m7					
							INDEX	W9-704010					
$\varnothing d_1$	M MF	l_1	l_2	l_3	$\varnothing d_2$	$\varnothing d_3 h6$	0280	●					
2,80	M3	62	20	12	6	6	0280	●					
3,70	M4	64	24	14	6	6	0370	●					
4,65	M5	80	28	20	6	6	0465	●					
5,55	M6	80	34	24	8	8	0555	●					
7,45	M8	80	47	30	10	10	0745	●					
9,30	M10	90	55	40	12	12	0930	●					
11,20	M12	100	60	45	14	14	1120	○					



HSSE

TN2

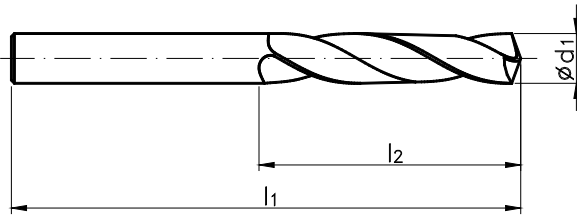
 DIN
338

INOX



Material groups



Internal cooling

- -

Quality of material

HSSE HSSE

Coating

- TN2

$\varnothing d_1$	M MF	M MF "WGN"	l_1	l_2	Norm	DIN-338	
					Tol.	h8	h8
					INDEX	W2-101811	W2-103811
1,00		M1,1	34	12	0100	●	○
1,10	M1,4	M1,2	36	14	0110	●	○
1,20			38	16	0120	●	○
1,30			38	16	0130	●	○
1,40			40	18	0140	●	○
1,50			40	18	0150	●	○
1,60	M2		43	20	0160	●	○
1,70			43	20	0170	●	○
1,80			46	22	0180	●	○
1,83		M2	46	22	0183	○	○
1,90	M2,3		46	22	0190	●	○
2,00		M2,2	49	24	0200	●	●
2,05	M2,5		49	24	0205	○	○
2,10			49	24	0210	●	○
2,20			53	27	0220	●	○
2,30		M2,5	53	27	0230	●	○
2,40			57	30	0240	●	○
2,50	M3		57	30	0250	●	●
2,60			57	30	0260	●	○
2,70			61	33	0270	●	○
2,80		M3	61	33	0280	●	○
2,90	M3,5		61	33	0290	●	○
3,00			61	33	0300	●	●
3,10			65	36	0310	●	○
3,20			65	36	0320	●	●
3,25		M3,5	65	36	0325	○	○
3,30	M4		65	36	0330	●	●
3,40			70	39	0340	●	○
3,50	M4x0,5		70	39	0350	●	●
3,60			70	39	0360	●	○
3,70	M4,5	M4	70	39	0370	●	○
3,80			75	43	0380	●	○
3,90			75	43	0390	●	○
4,00			75	43	0400	●	●
4,10			75	43	0410	●	○
4,20	M5		75	43	0420	●	●
4,30			80	47	0430	●	○
4,40			80	47	0440	●	○
4,50	M5x0,5		80	47	0450	●	●
4,60	M5,5		80	47	0460	●	○
4,65		M5	80	47	0465	○	○
4,70			80	47	0470	●	○
4,80			86	52	0480	●	○
4,90			86	52	0490	●	○
5,00	M6		86	52	0500	●	●
5,10			86	52	0510	●	●

					INOX																
<div style="display: flex; flex-direction: column; align-items: flex-start;"> <div style="border: 1px solid black; padding: 2px; margin-bottom: 5px;">HSSE</div> <div style="border: 1px solid black; padding: 2px; margin-bottom: 5px;">TN2</div> <div style="border: 1px solid black; padding: 2px;">DIN 338</div> </div>																					
Material groups					<table border="1"> <tr> <td>P</td><td>M</td><td>K</td> <td>P</td><td>M</td><td>K</td> </tr> <tr> <td>N</td><td>S</td><td>H</td> <td>N</td><td>S</td><td>H</td> </tr> </table>		P	M	K	P	M	K	N	S	H	N	S	H			
P	M	K	P	M	K																
N	S	H	N	S	H																
Internal cooling					-																
Quality of material					HSSE																
Coating					-																
$\varnothing d_1$	M MF	M MF "WGN"	l_1	l_2	Norm	DIN-338															
					Tol.	h8	h8														
					INDEX	W2-101811	W2-103811														
5,20	M6x0,75		86	52	0520	●	○														
5,30			86	52	0530	●	○														
5,40			93	57	0540	●	○														
5,50			93	57	0550	●	●														
5,55			93	57	0555	○	○														
5,60		M6	93	57	0560	●	○														
5,70			93	57	0570	●	○														
5,80			93	57	0580	●	○														
5,90			93	57	0590	●	○														
6,00	M7		93	57	0600	●	●														
6,10			101	63	0610	●	○														
6,20	M7x0,75		101	63	0620	●	○														
6,30			101	63	0630	●	○														
6,40			101	63	0640	●	○														
6,50			101	63	0650	●	●														
6,60		M7	101	63	0660	●	○														
6,70			101	63	0670	●	○														
6,80	M8		109	69	0680	●	●														
6,90			109	69	0690	●	●														
7,00	M8x1		109	69	0700	●	●														
7,10			109	69	0710	●	○														
7,20	M8x0,75		109	69	0720	●	○														
7,30			109	69	0730	●	○														
7,40		M8	109	69	0740	●	○														
7,50			109	69	0750	●	●														
7,60			117	75	0760	●	○														
7,70			117	75	0770	●	○														
7,80	M9		117	75	0780	●	○														
7,90			117	75	0790	●	○														
8,00	M9x1		117	75	0800	●	●														
8,10			117	75	0810	●	○														
8,20	M9x0,75		117	75	0820	●	●														
8,30			117	75	0830	●	○														
8,40			117	75	0840	●	○														
8,50	M10		117	75	0850	●	●														
8,60			125	81	0860	●	○														
8,70			125	81	0870	●	○														
8,80	M10x1,25		125	81	0880	●	○														
8,90			125	81	0890	●	○														
9,00	M10x1		125	81	0900	●	●														
9,10			125	81	0910	●	○														
9,20	M10x0,75		125	81	0920	●	○														
9,30		M10	125	81	0930	●	○														
9,40			125	81	0940	○	○														
9,50	M11		125	81	0950	●	●														
9,60			133	87	0960	○	○														

HSSE

TN2

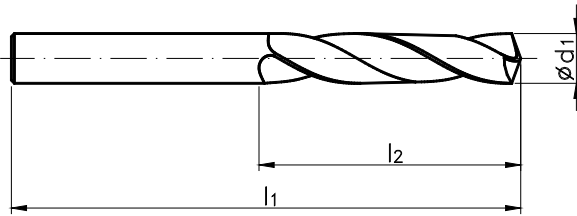
 DIN
338

INOX



Material groups



Internal cooling

- -

Quality of material

HSSE HSSE

Coating

- TN2

$\varnothing d_1$	M MF	M MF "WGN"	l_1	l_2	Norm	DIN-338	
					Tol.	h8	h8
					INDEX	W2-101811	W2-103811
9,70			133	87	0970	●	○
9,80			133	87	0980	●	○
9,90			133	87	0990	○	○
10,00	M11x1		133	87	1000	●	●
10,10			133	87	1010	●	○
10,20	M12		133	87	1020	●	●
10,30			133	87	1030	●	○
10,40			133	87	1040	○	○
10,50	M12x1,5		133	87	1050	●	●
10,60			133	87	1060	●	○
10,70			142	94	1070	○	○
10,80	M12x1,25		142	94	1080	●	○
10,90			142	94	1090	○	○
11,00	M12x1		142	94	1100	●	●
11,10			142	94	1110	○	○
11,20		M12	142	94	1120	●	○
11,30			142	94	1130	○	○
11,40			142	94	1140	○	○
11,50			142	94	1150	●	○
11,60			142	94	1160	○	○
11,70			142	94	1170	○	○
11,80			142	94	1180	●	○
11,90			151	101	1190	○	○
12,00	M14		151	101	1200	●	●
12,10			151	101	1210	●	○
12,20			151	101	1220	●	○
12,30			151	101	1230	●	○
12,50	M14x1,5		151	101	1250	●	●
12,60			151	101	1260	○	○
12,70			151	101	1270	●	○
12,80	M14x1,25		151	101	1280	●	○
12,90			151	101	1290	○	○
13,00	M14x1	M14	151	101	1300	●	●
13,20			151	101	1320	●	○
13,50			160	108	1350	●	○
13,80			160	108	1380	○	○
14,00	M16;M15x1		160	108	1400	●	●
14,50	M16x1,5		169	114	1450	●	○
15,00	M16x1	M16	169	114	1500	●	●
15,50	M18		178	120	1550	○	○
16,00	M18x2		178	120	1600	●	●

HSS

TN2

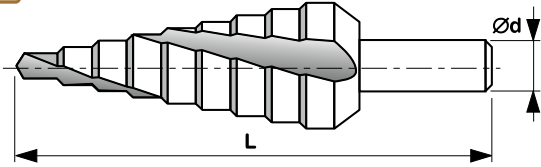

Material groups				-	-	-	-
Internal cooling				-	-	-	-
Quality of material				HSS	HSS	HSS	HSS
Coating				-	-	TN2	TN2
Flute type				straight	spiral R25	straight	spiral R25
Ø d	L	Ø D	INDEX	INDEX	INDEX	INDEX	
8	75	4/6/8/10/12/14/16/18/20	W1-641010-0420	W1-648010-0420	W1-646010-0420	W1-649010-0420	
10	100	6/8/10/12/14/16/18/20/22/24/26/28/30	W1-641020-0630	W1-648020-0630	W1-646020-0630	W1-649020-0630	
10	100	6/9/13/16/19/21/23/26/29/32/35/38	W1-641030-0638	W1-648030-0638	W1-646030-0638	W1-649030-0638	
10	100	6/9/11,4/14/17,25/19/21,25/24/26,75/30/33/35,7	W1-642030-0636	W1-645030-0636	-	-	
10	100	6/9/12,5/15,2/18,6/20,4/22,5/26/28,3/30,5/34/37	W1-642040-0637	W1-645040-0637	-	-	



VHM

AT

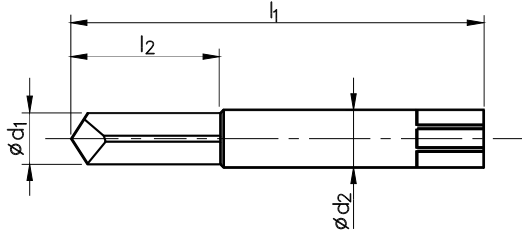

WDG



Material groups



Internal cooling

-

Quality of material

VHM

Coating

AT

Ø d ₁	M	l ₁ ±2	l ₂ ±2	Ø d ₂	Norm	INDEX
					Tol.	
2,5	M3	38	10	3	0250	●
3,3	M4	46	14	4	0330	●
4,2	M5	50	19	5	0420	●
5,0	M6	50	23	6	0500	●
6,8	M8	60	23	8	0680	●
8,5	M10	80	25	10	0850	●
10,2	M12	80	35	12	1020	●

6

Operation instruction:

- The workpiece has to be clamped very stable and safe.
 - The overlapping part of the tap has to be made plane with the workpiece.
 - Centering of the drill by multiple tip-centering. In case of tip-centering with an NC machine please choose a lower cutting feed.
 - The remove of a tap can be made with an NC machine with lubrication (Attention: risk of bonding) also by hand with a bench drilling or column drilling machine. Multiple chipping removal is absolutely necessary.
 - Remove of remaining chippings with compressed air or with a scriber.
 - New thrad cutting with a new tap
 - After finishing the new thread please test the size accuracy.
- 1-5 taps can be remove with one drill to remove jammed taps.
 Regrinding of drills to remove jammed taps is not economical.
 Due to the hexagon this drill can also be clamped in normal three- or four-jaw chucks.
 In case of correct use the core hole will not be damaged in all materials, also in Cu or Al and hardened materials

Feed		fz		fz		fz		fz		fz	
Vc m/min		φ3,3-6,8		φ6,8-10,2		φ10,2-14,0		φ14,0-15,5		φ15,5-17,5	
od	do	od	do	od	do	od	do	od	do	od	do
10	12	0,040	0,08	0,08	0,110	0,110	0,140	0,140	0,150	0,150	0,170



Drill set to remove broken taps
p. 260





For spot and chamfering thread holes in one operation

- VHM
- TN2
- HSSE

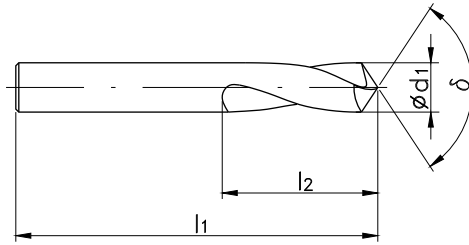

Material groups	<table border="1"> <tr><td>P</td><td>M</td><td>K</td></tr> <tr><td>N</td><td>S</td><td>H</td></tr> </table>		P	M	K	N	S	H	<table border="1"> <tr><td>P</td><td>M</td><td>K</td></tr> <tr><td>N</td><td>S</td><td>H</td></tr> </table>		P	M	K	N	S	H	<table border="1"> <tr><td>P</td><td>M</td><td>K</td></tr> <tr><td>N</td><td>S</td><td>H</td></tr> </table>		P	M	K	N	S	H
P	M	K																						
N	S	H																						
P	M	K																						
N	S	H																						
P	M	K																						
N	S	H																						
Internal cooling	-		-		-																			
Quality of material	HSSE		HSSE		VHM																			
Coating	TN2		TN2		-																			
Point angle	90°		120°		142°																			
Ø d ₁	δ90 / δ120°		δ142°		Norm																			
	l ₁	l ₂	l ₁	l ₂	Tol.																			
					INDEX	W2-003012	W2-003013	W9-001014																
3,0	46	12	45	12,0	0300	●	○	○																
4,0	55	12	50	15,0	0400	●	●	●																
5,0	62	15	50	18,0	0500	●	●	●																
6,0	66	20	50	21,0	0600	●	○	○																
8,0	79	25	60	25,0	0800	○	○	○																
10,0	89	25	70	27,0	0100	○	○	○																
12,0	102	30	70	27,0	0120	●	●	●																
14,0	107	34	75	30,0	0140	○	○	○																
16,0	115	35	75	30,0	0160	○	○	○																

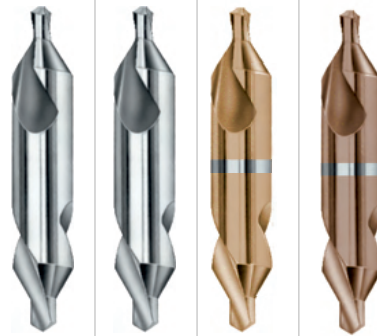
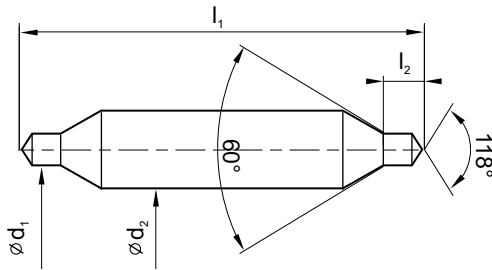

		Vc[m/min]			Feed [mm/rev]		
		HSSE	HSSE+TN2	VHM	Ø2-Ø6	Ø6-Ø10	Ø10-Ø16
P	Rm<500	35-45	45-55	40-55	0,08-0,15	0,15-0,25	0,25-0,30
	Rm<800	30-40	40-50		0,08-0,15	0,15-0,25	0,25-0,30
	Rm<1000	25-35	35-45		0,05-0,14	0,14-0,20	0,20-0,25
	Rm<1400	8-10	12-15		25-30	0,04-0,12	0,12-0,15
M		10-15	15-20	25-30	0,04-0,12	0,12-0,18	0,18-0,22
K		20-30	30-40	45-50	0,08-0,15	0,15-0,20	0,20-0,25
N		35-80	45-90	55-110	0,08-0,15	0,15-0,20	0,20-0,25
S		5-6	8-10	20-30	0,03-0,06	0,06-0,12	0,12-0,15
H		-	-	10-15	0,04-0,06	0,06-0,10	0,10-0,12

For center drilling, A type
HSS
HSSE
VHM
DIN 333 A
TN2
AT

Material groups



Internal cooling

- - - -

Quality of material

HSS **HSSE** **HSSE** **VHM**

Coating

- - TN2 AT

Point angle

60° 60° 60° 60°

d ₁	d ₂	l ₁	l ₂ min-max	Norm INDEX	DIN-333 A			
					W1-011021	W2-011021	W2-013021	W9-01L021
0,8	3,15	25	1,0-1,3	0080	●	○	○	○
1,0	3,15	31	1,3-1,7	0100	●	○	○	○
1,25	3,15	31	1,6-2,0	0125	●	○	○	○
1,6	4,0	35	2,0-2,6	0160	●	○	○	○
2,0	5,0	40	2,5-3,1	0200	●	○	○	○
2,5	6,3	45	3,1-3,8	0250	●	○	○	○
3,15	8,0	50	3,9-4,6	0315	●	○	○	○
4,0	10,0	55	5,0-5,9	0400	○	○	○	○
5,0	12,5	63	6,3-7,2	0500	●	○	○	○
6,3	16,0	71	8,0-8,9	0630	●	○	○	○
8,0	20,0	80	10,1-11,1	0800	●	○	○	○
10,0	25,0	100	12,8-13,8	1000	●	○	○	○

		Vc[m/min]				Feed [mm/rev]		
		HSS	HSSE	HSSE+TN2	VHM	ø2-ø6	ø6-ø10	ø10-ø16
P	Rm<500	30-35	35-45	45-55	-	0,08-0,15	0,15-0,25	0,25-0,30
	Rm<800	20-25	30-40	40-50	-	0,08-0,15	0,15-0,25	0,25-0,30
	Rm<1000	15-25	25-35	35-45	25-30	0,05-0,14	0,14-0,20	0,20-0,25
	Rm<1400	-	8-10	12-15	25-30	0,04-0,12	0,12-0,15	0,15-0,18
M		6-10	10-15	15-20	25-40	0,04-0,12	0,12-0,18	0,18-0,22
K		15-20	20-30	30-40	45-50	0,08-0,15	0,15-0,20	0,20-0,25
N		30-80	35-80	45-90	60-150	0,08-0,15	0,15-0,20	0,20-0,25
S		-	5-6	8-10	20-30	0,03-0,06	0,06-0,12	0,12-0,15
H		-	-	-	10-15	0,04-0,05	0,06-0,1	0,1-0,12

For center drilling, B type

HSS

DIN 333 B

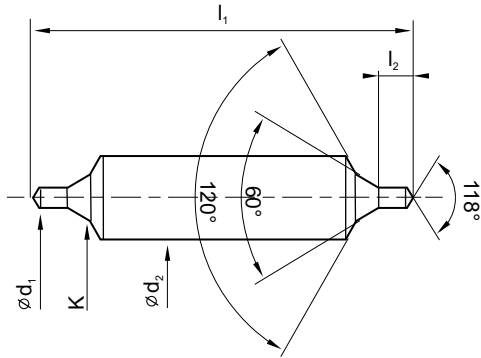

Material groups



Internal cooling

-

Quality of material

HSS

Coating

-

Point angle

60°

d ₁	d ₂	K	l ₁	l ₂ min-max	Norm	DIN-333 B				
					INDEX	W1-021021				
1,00	4,0	2,1	35	1,3~1,7	0100	●				
1,25	5,0	2,6	40	1,6~2,0	0125	●				
1,60	6,3	3,3	45	2,0~2,6	0160	●				
2,00	8,0	4,2	50	2,5~3,1	0200	●				
2,50	10,0	5,3	55	3,1~3,8	0250	●				
3,15	11,2	6,7	62	3,9~4,6	0315	●				
4,00	14,0	8,5	69	5,0~5,9	0400	●				
5,00	18,0	10,6	77	6,3~7,2	0500	●				
6,30	20,0	13,2	80	8,0~8,9	0630	●				

	Rm	Vc (m/min)	Feed [mm/rev]		
			ø2-ø6	ø6-ø10	ø10-ø16
P	Rm<500	30-35	0,08-0,15	0,15-0,25	0,25-0,30
	Rm<800	20-25	0,08-0,15	0,15-0,25	0,25-0,30
	Rm<1000	15-25	0,05-0,14	0,14-0,20	0,20-0,25
	Rm<1400	-	-	-	-
M		6-10	0,04-0,12	0,12-0,18	0,18-0,22
K		15-20	0,08-0,15	0,15-0,20	0,20-0,25
N		30-80	0,08-0,15	0,15-0,20	0,20-0,25



B type center drills advantages

B type center drill

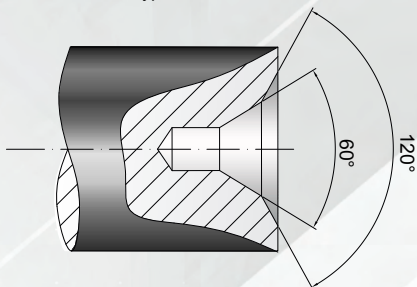

Removes burrs of center hole

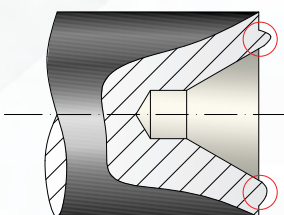

It is recommended to use type B center drills when poor quality of the workpieces surface

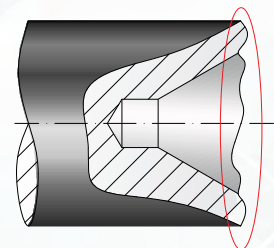

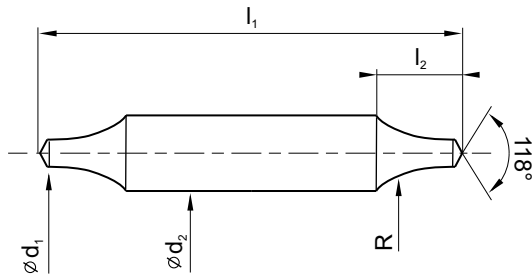
For center drilling, R type
HSS
DIN 333 R

Material groups	P M K N S H
Internal cooling	-
Quality of material	HSS
Coating	-
Point angle	60°

6

d ₁	d ₂	R	l ₁	l ₂ min-max	Norm	DIN-333 R
					INDEX	W1-031021
1,00	3,15	2,90	31	3,0~3,3	0100	●
1,25	3,15	3,15	31	3,3~3,6	0125	●
1,00	4,00	3,90	35	3,3~3,6	0100a	●
1,60	4,00	4,00	35	4,2~4,7	0160	●
1,50	5,00	5,00	40	4,5~4,9	0150	●
2,00	5,00	5,00	40	5,0~5,4	0200	●
2,00	6,00	5,80	45	5,4~5,8	0200a	●
2,50	6,30	6,30	45	6,3~6,8	0250	●
2,50	8,00	8,00	50	7,5~8,0	0250a	●
3,00	8,00	8,00	50	8,0~8,5	0300	●
3,15	8,00	8,00	50	8,0~8,5	0315	●
4,00	10,00	10,00	55	10,0~10,6	0400	●
5,00	12,50	12,50	63	12,5~13,1	0500	●

	Vc (m/min)	Feed [mm/rev]			
		ø2-ø6	ø6-ø10	ø10-ø16	
P	Rm<500	30-35	0,08-0,15	0,15-0,25	0,25-0,30
	Rm<800	20-25	0,08-0,15	0,15-0,25	0,25-0,30
	Rm<1000	15-25	0,05-0,14	0,14-0,20	0,20-0,25
	Rm<1400	-	-	-	-
M	6-10	0,04-0,12	0,12-0,18	0,18-0,22	
K	15-20	0,08-0,15	0,15-0,20	0,20-0,25	
N	30-80	0,08-0,15	0,15-0,20	0,20-0,25	

R type center drills advantages

Universal use for different angles of lathe centers

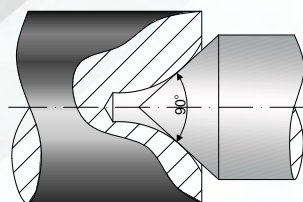
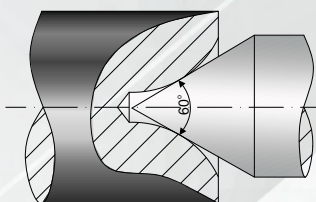

Can be used for turning taper by the tailstock offset method

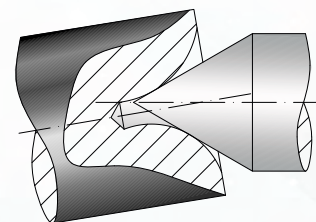

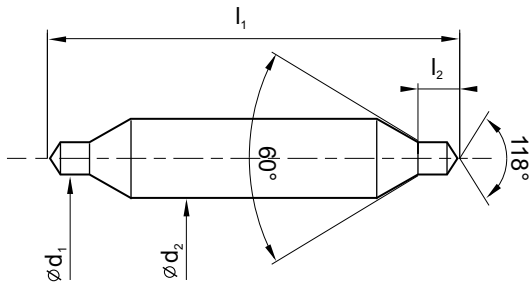
For center drilling, EL type
HSSE
**DIN
333 EL**

Material groups



Internal cooling

-

Quality of material

HSSE

Coating

-

Point angle

60°

d ₁	d ₂	l ₁	l ₂ min-max	Norm	DIN-333 EL				
				INDEX	W2-041021				
1,50	5,0	100	2,0~2,6	0150	●				
2,00	6,0	100	2,5~3,1	0200	●				
2,50	8,0	120	3,1~3,8	0250	●				
3,15	10,0	120	3,9~4,6	0315	●				
4,00	10,0	120	5,0~5,9	0400	●				
5,00	14,0	120	6,3~7,2	0500	●				

6

	Rm	Vc (m/min)	Feed [mm/rev]		
			ø2-ø6	ø6-ø10	ø10-ø16
P	Rm<500	35-45	0,08-0,15	0,15-0,25	0,25-0,30
	Rm<800	30-40	0,08-0,15	0,15-0,25	0,25-0,30
	Rm<1000	25-35	0,05-0,14	0,14-0,20	0,20-0,25
	Rm<1400	8-10	0,04-0,12	0,12-0,15	0,15-0,18
M		10-15	0,04-0,12	0,12-0,18	0,18-0,22
K		20-30	0,08-0,15	0,15-0,20	0,20-0,25
N		35-80	0,08-0,15	0,15-0,20	0,20-0,25
S		5-6	0,03-0,06	0,06-0,12	0,12-0,15

For chamfering thread holes

VHM

AT

DIN
6537L

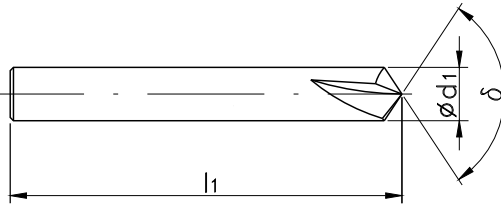

Material groups



Internal cooling

- -

Quality of material

VHM VHM

Coating

AT AT

Point angle

60° 90°

6

Ø d ₁	l ₁	z	Norm	DIN-6537L	
			Tol.		
			INDEX	W9-054011	W9-054012
4,0	54	4	0400	●	●
6,0	57	4	0600	●	●
8,0	63	5	0800	●	●
10,0	72	6	1000	●	●
12,0	83	6	1200	●	●
16,0	92	6	1600	●	●
20,0	104	6	2000	○	○

		Vc (m/min)	Feed [mm/tooth]						
			Ø4	Ø6	Ø8	Ø10	Ø12	Ø16	Ø20
P	Rm<500	150-200	0,025-0,030	0,036-0,041	0,052-0,058	0,066-0,073	0,085-0,090	0,100-0,110	0,120-0,130
	Rm<800	130-180	0,023-0,028	0,036-0,039	0,052-0,055	0,065-0,070	0,079-0,085	0,095-0,100	0,110-0,120
	Rm<1000	100-150	0,018-0,025	0,033-0,039	0,047-0,053	0,059-0,065	0,072-0,079	0,088-0,095	0,100-0,110
	Rm<1400	90-120	0,018-0,025	0,028-0,033	0,042-0,047	0,053-0,059	0,063-0,072	0,079-0,088	0,095-0,100
M		70-100	0,020-0,025	0,033-0,039	0,047-0,053	0,059-0,065	0,072-0,079	0,088-0,095	0,100-0,110
K		100-150	0,025-0,028	0,035-0,039	0,050-0,055	0,060-0,065	0,079-0,085	0,095-0,100	0,110-0,120
N		150-300	0,025-0,030	0,035-0,041	0,050-0,058	0,060-0,073	0,079-0,090	0,095-0,110	0,110-0,130
S		40-60	0,010-0,015	0,017-0,024	0,024-0,032	0,030-0,038	0,036-0,046	0,045-0,054	0,057-0,066

For two sided edge and holes chamfering and deburring

VHM

TS

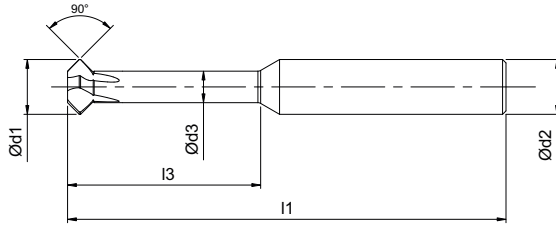

Material groups



Internal cooling

-

Quality of material

VHM

Coating

AT

Point angle

90°

d_1	d_2	d_3	l_1	l_3	z	INDEX
2,5	3	1,5	39	6,5	3	M9-05G012-0250
3	3	1,8	39	8	3	M9-05G012-0300
3	3	1,8	39	12	3	M9-05G012-0300A
3,5	4	2,1	50	8,5	3	M9-05G012-0350
3,5	4	2,1	50	14	3	M9-05G012-0350A
4	4	2,4	50	10	3	M9-05G012-0400
4	4	2,4	50	16	3	M9-05G012-0400A
5	5	2,8	50	12,5	3	M9-05G012-0500
5	5	2,8	50	20	3	M9-05G012-0500A
6	6	3	57	15	4	M9-05G012-0600
6	6	3	57	24	4	M9-05G012-0600A
6	6	3	100	24	4	M9-05G012-0600B
8	8	4,8	63	20	4	M9-05G012-0800
8	8	4,8	63	32	4	M9-05G012-0800A
8	8	4,8	100	32	4	M9-05G012-0800B

		Vc (m/min)	Feed [mm/tooth]				
			$\varnothing 1\text{-}\varnothing 2$	$\varnothing 3\text{-}\varnothing 4$	$\varnothing 6\text{-}\varnothing 8$	$\varnothing 10\text{-}\varnothing 12$	$\varnothing 16$
P	Rm<500	70-90	0,010	0,012	0,015	0,020	0,030
	Rm<800	50-80	0,010	0,012	0,015	0,020	0,030
	Rm<1000	45-60	0,010	0,012	0,013	0,017	0,025
	Rm<1400	40-55	0,010	0,012	0,013	0,017	0,025
M		35-50	0,007	0,010	0,010	0,015	0,020
K		40-60	0,010	0,012	0,013	0,017	0,025
N		60-180	0,012	0,012	0,015	0,020	0,030
S		25-40	0,007	0,010	0,010	0,015	0,020

Practical example

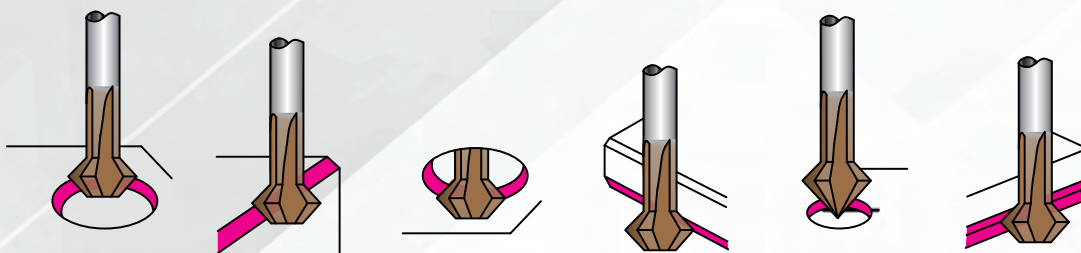

HSSE DIN 335 C

VHM

TN2

TC

AT

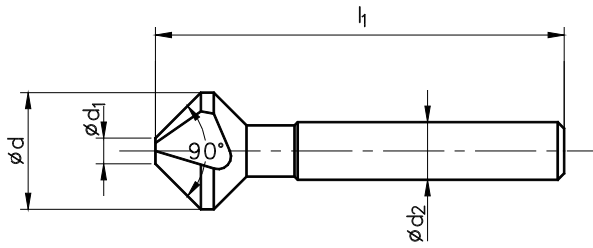

Material groups



Internal cooling

- - - -

Quality of material

HSSE HSSE HSSE VHM

Coating

- TN2 TC AT

Point angle

90° 90° 90° 90°

6

ød	ød ₁	ød ₂	l ₁	Norm	DIN-335			
				Tol.				
				INDEX	T2-040010	T2-043010	T2-045110	T9-04V010
6,3	1,50	5	45	0063	●	●	●	●
8,3	2,00	6	50	0083	●	●	●	●
10,4	2,50	6	50	0104	●	●	●	●
12,4	2,80	8	56	0124	●	●	●	●
16,5	3,20	10	60	0165	●	●	●	●
20,5	3,50	10	63	0205	●	●	●	●
25,0	3,80	10	67	0250	●	●	●	●
30,0	4,20	12	71	0300	●	●	●	●

		Vc (m/min)		Feed [mm/tooth]							
		HSSE	VHM	ø6,3	ø8,3	ø10,4	ø12,4	ø16,5	ø20,5	ø25	ø30
P	Rm<500	17-22	40-80	0,12	0,13	0,14	0,15	0,17	0,18	0,21	0,24
	Rm<800	10-15	30-60	0,07	0,08	0,09	0,10	0,11	0,13	0,15	0,17
	Rm<1000	8-12	20-40	0,07	0,08	0,09	0,10	0,11	0,13	0,15	0,17
	Rm<1400	-	15-20	0,07	0,08	0,09	0,10	0,11	0,13	0,15	0,17
M		6-10	20-40	0,07	0,08	0,09	0,10	0,11	0,13	0,15	0,17
K		15-25	40-80	0,12	0,13	0,14	0,15	0,17	0,18	0,21	0,24
N		15-45	40-100	0,19	0,20	0,22	0,23	0,26	0,28	0,30	0,36
S		-	10-12	0,04	0,05	0,06	0,06	0,07	0,08	0,09	0,12
H		-	10-12	0,04	0,05	0,06	0,06	0,07	0,08	0,09	0,12



Countersinks set p. 260



HSS

DIN 335 D

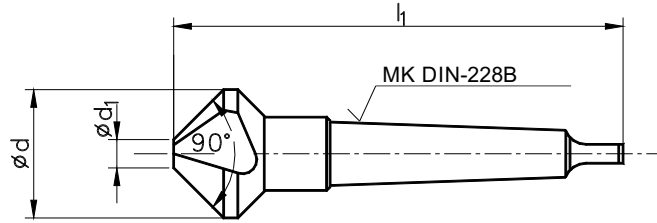

Material groups					<table border="1"> <tr> <td>P</td> <td>M</td> <td>K</td> </tr> <tr> <td>N</td> <td>S</td> <td>H</td> </tr> </table>		P	M	K	N	S	H				
P	M	K														
N	S	H														
Internal cooling					-											
Quality of material					HSS											
Coating					-											
Ø d	Ø d ₁	l ₁	MK DIN-228B	INDEX	T1-040210											
37	4,8	118	2	0370	●											
Ø d	Ø d ₁	l ₁	MK DIN-228B	INDEX	T1-040310											
50	14	150	3	0500	●											
Ø d	Ø d ₁	l ₁	MK DIN-228B	INDEX	T1-040410											
63,0	16,00	180	4	0630	●											
80,0	20,00	180	4	0800	●											



PF

$\varnothing D_1$	$\varnothing D_c$	κ	A	B	Z	INDEX	
40	34	30°	14,5	25,5	1	T9-100013-0400	●
56	46	45°	20,5	20,5	2	T9-100012-0560	●
72	55	60°	14,5	14,5	2	T9-100011-0720	●

Accessories

Designation	INDEX
Insert AH 330	T9-104000-0127
Clamping screw	T9-100001-0000
Key	T9-100002-0000

Processing parameters

Material	feed f_z (mm/tooth)
Carbon steel	0,1~0,25
Superalloys	0,1~0,2
Tool steel	0,1~0,2
Stainless	0,1~0,25
Cast iron	0,1~0,25

6

Z-axis plunging depth Z (mm)

- For the phase 30°

hole dia. $\varnothing d$ (mm)	Size of chamfering C (mm)						
	0,5	1	1,5	2	2,5	3	3,5
5	0,6	1,1	1,6	2,1			
6	0,9	1,4	1,9	2,4			
6,8	1,1	1,6	2,1	2,6			
8	1,4	1,9	2,4	2,9			
8,5	1,6	2,1	2,6	3,1			
10	2,0	2,5	3,0	3,5	4,0	4,5	5,0
10,2	2,1	2,6	3,1	3,6	4,1	4,6	5,1
12	2,6	3,1	3,6	4,1	4,6	5,1	5,6
16	3,7	4,2	4,7	5,2	5,7	6,2	6,7
17,5	4,2	4,7	5,2	5,7	6,2	6,7	7,2
20	4,9	5,4	5,9	6,4	6,9	7,4	7,9
21	5,2	5,7	6,2	6,7	7,2	7,7	8,2
24	6,1	6,6	7,1	7,6	8,1	8,6	9,1
30	7,8	8,3	8,8	9,3	9,8	10,3	10,8
33	8,7	9,2	9,7	10,2	10,7	11,2	11,7
36	9,5	10,0	10,5	11,0	11,5	12,0	12,5
38	10,1	10,6	11,1	11,6	12,1	12,6	13,1
42	11,2	11,7	12,2	12,7	13,2	13,7	14,2
46	12,4	12,9	13,4	13,9	14,4		
48	13,0	13,5	14	14,5			
52	14,1						

- For the phase 45°

hole dia. $\varnothing d$ (mm)	Size of chamfering C (mm)							
	0,5	1	1,5	2	2,5	3	3,5	4
5	0,8	1,3	1,8	2,3	2,8			
6	1,7	2,2	2,7	3,2	3,7			
6,8	2,4	2,9	3,4	3,9	4,4			
8	3,4	3,9	4,4	4,9	5,4			
8,5	3,8	4,3	4,8	5,3	5,8			
10	5,1	5,6	6,1	6,6	7,1	7,6	8,1	8,6
10,2	5,3	5,8	6,3	6,8	7,3	7,8	8,3	8,8
12	6,9	7,4	7,9	8,4	8,9	9,4	9,9	10,4
16	10,3	10,8	11,3	11,8	12,3	12,8	13,3	13,8
17,5	11,6	12,1	12,6	13,1	13,6	14,1	14,6	15,1
20	13,7	14,2	14,7	15,2	15,7	16,2	16,7	17,2
21	14,6	15,1	15,6	16,1	16,6	17,1	17,6	18,1
24	17,2	17,7	18,2	18,7	19,2	19,7	20,2	20,7
30	22,4	22,9	23,4	23,9	24,4	24,9	25,4	
33	24,9	25,4						

- For the phase 60°

hole dia. $\varnothing d$ (mm)	Size of chamfering C (mm)						
	0,5	1	1,5	2	3	4	5
5	0,7	1,2	1,7	2,2	3,2		
6	1,2	1,7	2,2	2,7	3,7		
6,8	1,6	2,1	2,6	3,1	4,1		
8	2,2	2,7	3,2	3,7	4,7		
8,5	2,4	2,9	3,4	3,9	4,9		
10	3,2	3,7	4,2	4,7	5,7	6,7	7,7
10,2	3,3	3,8	4,3	4,8	5,8	6,8	7,8
12	4,2	4,7	5,2	5,7	6,7	7,7	8,7
14	5,2	5,7	6,2	6,7	7,7	8,7	9,7
16	6,2	6,7	7,2	7,7	8,7	9,7	10,7
17,5	6,9	7,4	7,9	8,4	9,4	10,4	11,4
20	8,2	8,7	9,2	9,7	10,7	11,7	12,7
21	8,7	9,2	9,7	10,2	11,2	12,2	13,2
24	10,2	10,7	11,2	11,7	12,7	13,7	14,7
30	13,2	13,7	14,2	14,7	15,7	16,7	17,7
33	14,7	15,2	15,7	16,2	17,2	18,2	19,2
36	16,2	16,7	17,2	17,7	18,7	19,7	
42	19,2	19,7	20,2				

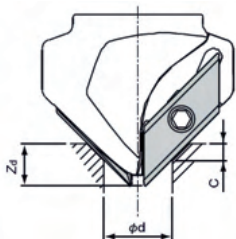

Note:
When the hole depth is smaller than the Z-axis plunging depth (Z_d), special care should be taken to avoid an interference between the tool's front end and the bottom of the hole.

Technical informations

- When the hole diameter to be chamfered is small or the cutting edges near the front end of tool are used, use at higher side of the revolution range shown in the Table. In contrast, when the hole diameter to be chamfered is large or the cutting edges far from the tool's front end are used, use the lower side of the revolution range shown in the Table.
- When chamfering a small diameter hole (smaller than $\varnothing 10$ mm) in a plungemilling mode, peck-feeding should not be used.
- When the hole diameter to be chamfered is smaller than $\varnothing 10$ mm or the cutting edges near the tool's front end are used, the feed should be set within 0.15 mm/t.

									DIN-373							
<div style="border: 1px solid black; padding: 2px; display: inline-block; margin-bottom: 10px;">HSS</div>																
Execution									N	F	M					
Lead									in tapping holes	in exact clearance hole	in medium clearance hole					
Hole type																
Material type									HSS	HSS	HSS					
D z9	d ₁ e8	d h9	l	l ₁	l ₂	L	M	Norm	DIN-373							
								Tol.								
								INDEX	T1-044010							
6,0	2,5	5,0	14	3,0	31,5	71	M3	6025	●							
6,5	2,9	5,0	14	3,5	31,5	71	M3,5	6529	●							
8,0	3,3	5,0	14	4,0	31,5	71	M4	8033	●							
10,0	4,2	8,0	18	5,0	35,5	80	M5	1042	●							
11,0	5,0	8,0	18	6,0	35,5	80	M6	1150	●							
15,0	6,8	12,5	22	8,0	40,0	100	M8	1568	●							
18,0	8,5	12,5	22	10,0	40,0	100	M10	1885	●							
20,0	10,2	12,5	22	12,0	40,0	100	M12	2010	●							
D z9	d ₁ e8	d h9	l	l ₁	l ₂	L	M	Norm	DIN-373							
								Tol.								
								INDEX	T1-045010							
6,0	3,2	5,0	14	3,0	31,5	71	M3	6032	●							
6,5	3,7	5,0	14	3,5	31,5	71	M3,5	6537	●							
8,0	4,3	5,0	14	4,0	31,5	71	M4	8043	●							
10,0	5,3	8,0	18	5,0	35,5	80	M5	1053	●							
11,0	6,4	8,0	18	6,0	35,5	80	M6	1164	●							
15,0	8,4	12,5	22	8,0	40,0	100	M8	1584	●							
18,0	10,5	12,5	22	10,0	40,0	100	M10	1810	●							
20,0	13,0	12,5	22	12,0	40,0	100	M12	2013	●							
D z9	d ₁ e8	d h9	l	l ₁	l ₂	L	M	Norm	DIN-373							
								Tol.								
								INDEX	T1-046010							
6,0	3,4	5,0	14	3,0	31,5	71	M3	6034	●							
6,5	3,9	5,0	14	3,5	31,5	71	M3,5	6539	●							
8,0	4,5	5,0	14	4,0	31,5	71	M4	8045	●							
10,0	5,5	8,0	18	5,0	35,5	80	M5	1055	●							
11,0	6,6	8,0	18	6,0	35,5	80	M6	1166	●							
15,0	9,0	12,5	22	8,0	40,0	100	M8	1590	●							
18,0	11,0	12,5	22	10,0	40,0	100	M10	1811	●							
20,0	14,0	12,5	22	12,0	40,0	100	M12	2014	●							



HSS

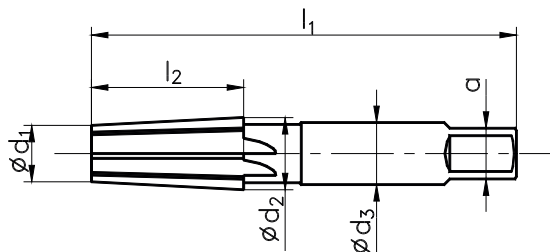

ASME B94,2-1995



Material type

HSS

Execution

C

Ø nom	Ø d ₁	Ø d ₂	Ø d ₃	l ₁	l ₂	a	Norm	INDEX
							Tol.	
1/4	10,30	12,00	14,3	62	27	10,7	0027	T1-030010
3/8	13,70	15,40	17,5	65	27	13,5	0029	•
1/2	16,90	19,10	17,5	79	35	13,0	0031	•
3/4	22,25	24,40	23,0	82	35	17,5	0035	•

6



Information concerning dimensions of the holes for tapere threas in the technical part of the catalogue p. 333



END MILLS

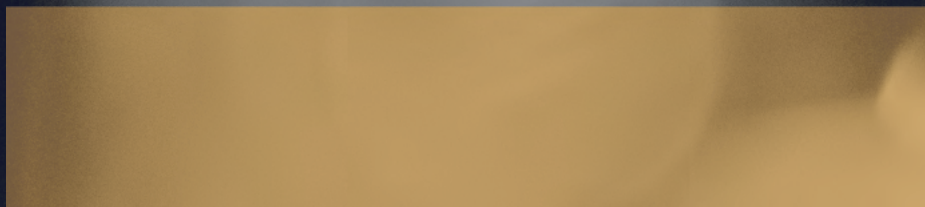

SELECTION TABLE

9 - 11

CATALOGUE PAGES

181 - 214

	MASTERMILL	High performance tools designed for machining steel and stainless steel with a hardness of up to 45HRC, cast iron, non-ferrous metals, and heat-resistant alloys.	181 - 183
	X-MILL	The range of general purpose tools designed for machining steel and cast iron of a hardness of up to 35 HRC.	184 - 195
	ZGR	General purpose tools with chip breaker for roughing.	196 - 197
	HRC	End mills made of carbide grade with nanometric grain size ($\leq 0.2 \mu\text{m}$). Designed for machining hardened materials. They have a TS coating and a geometry that allows them to machine materials with a hardness of up to 65 HRC.	198 - 200
	AL	The range of VHM end mills is designed for high-performance machining of non-ferrous metals such as aluminium alloys or copper. They are characterised by optimised geometry, polished chip grooves, and a dedicated TB coating for aluminium machining.	201 - 212
	MultiCUT	Multifunctional end mill for grooving, profiling, spot drilling, chamfering and engraving.	213
	Tapered end mill 1:16	End mill for preparation of tapered hole for NPT, NPTF, Rc threads.	214

For machining steel and cast iron with hardness up to 45 HRC, stainless steel and difficult to machine materials

MASTERMILL



Z=4

Version without corner radius is protected by corner chamfer $r_1 = 0,2 \times 45^\circ$



λ
42°-45°

VHM

TS

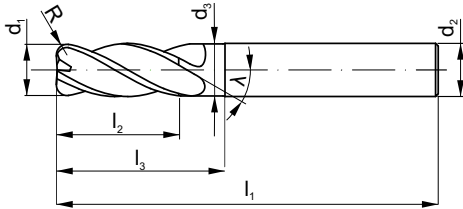

440N

R440N



Workpiece material



Shank



Tool material

VHM

VHM

Coating

TS

TS

Corner type



d ₁	d ₂ h6	d ₃	l ₁	l ₂	l ₃	Z	R	INDEX	
3	6	2,8	57	8	14	4	0,3	M9-44GMA0-0030	M9-44GMAD-0030
4	6	2,8	57	11	17	4	0,3	M9-44GMA0-0040	M9-44GMAD-0040
5	6	2,8	57	13	19	4	0,3	M9-44GMA0-0050	M9-44GMAD-0050
6	6	5,5	57	13	21	4	0,25	M9-44GMA0-0060	M9-44GMAC-0060
6	6	5,5	57	13	21	4	0,5	-	M9-44GMA1-0060
6	6	5,5	57	13	21	4	1	-	M9-44GMA3-0060
8	8	7,5	63	19	27	4	0,5	M9-44GMA0-0080	M9-44GMA1-0080
8	8	7,5	63	19	27	4	1	-	M9-44GMA3-0080
10	10	9,5	72	22	32	4	0,5	M9-44GMA0-0100	M9-44GMA1-0100
10	10	9,5	72	22	32	4	1	-	M9-44GMA3-0100
10	10	9,5	72	22	32	4	1,5	-	M9-44GMA4-0100
12	12	11,5	83	26	38	4	0,5	M9-44GMA0-0120	M9-44GMA1-0120
12	12	11,5	83	26	38	4	1	-	M9-44GMA3-0120
14	14	13	83	26	38	4	0,5	M9-44GMA0-0140	M9-44GMA1-0140
16	16	15	92	32	44	4	0,5	M9-44GMA0-0160	M9-44GMA1-0160
16	16	15	92	32	44	4	1	-	M9-44GMA3-0160
16	16	15	92	32	44	4	3	-	M9-44GMA7-0160
18	18	17	92	32	44	4	0,5	M9-44GMA0-0180	M9-44GMA1-0180
20	20	19	104	38	55	4	0,5	M9-44GMA0-0200	M9-44GMA1-0200
20	20	19	104	38	55	4	1	-	M9-44GMA3-0200

ISO	V _c [m/min]	d, [mm]								
		6	8	10	12	14	16	18	20	
P	P1-P4	150-200	0,020	0,030	0,045	0,055	0,060	0,065	0,070	0,080
	P5-P12	120-160	0,015	0,030	0,040	0,045	0,050	0,055	0,060	0,065
	P13	70-130	0,010	0,020	0,020	0,035	0,040	0,045	0,050	0,055
	P14	70-110	0,010	0,020	0,020	0,035	0,040	0,045	0,050	0,055
M	M1	90-140	0,010	0,020	0,020	0,035	0,040	0,045	0,050	0,055
	M2-M3	70-100	0,015	0,025	0,040	0,045	0,050	0,055	0,060	0,065
K	K1-K6	140-200	0,020	0,025	0,040	0,045	0,050	0,055	0,060	0,065
N	N1-N5	240-280	0,050	0,055	0,065	0,075	0,080	0,085	0,090	0,095
	N7-N10	260-300	0,050	0,055	0,060	0,070	0,075	0,080	0,085	0,090
S	S1-S5	30-50	0,020	0,030	0,050	0,055	0,060	0,065	0,070	0,075
	S6-S8	40-70	0,020	0,035	0,050	0,055	0,060	0,065	0,070	0,075

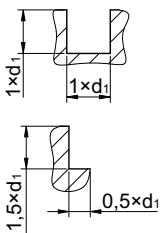

MASTERMILL



For machining steel and cast iron with hardness up to 45 HRC, stainless steel and difficult to machine materials

MASTERMILL

B440N

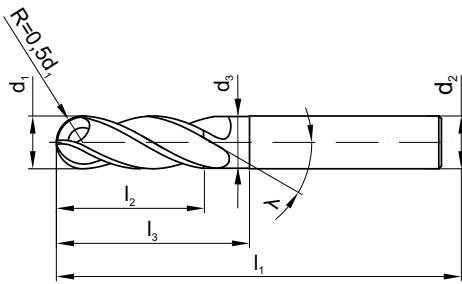
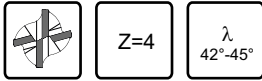

Workpiece material



Shank



Tool material

VHM

Coating

TS

Corner type



d ₁	d ₂ h6	d ₃	l ₁	l ₂	l ₃	Z	R	INDEX
3	6	-	57	8	-	4	1,5	M9-44GMAX-0030
4	6	-	57	11	-	4	2,0	M9-44GMAX-0040
5	6	-	57	13	-	4	2,5	M9-44GMAX-0050
6	6	5,5	57	13	21	4	3,0	M9-44GMAX-0060
8	8	7,5	63	19	27	4	4,0	M9-44GMAX-0080
10	10	9,5	72	22	32	4	5,0	M9-44GMAX-0100
12	12	11,5	83	26	38	4	6,0	M9-44GMAX-0120
14	14	13	83	26	38	4	7,0	M9-44GMAX-0140
16	16	15	92	32	44	4	8,0	M9-44GMAX-0160
18	18	17	92	32	44	4	9,0	M9-44GMAX-0180
20	20	19	104	38	55	4	10,0	M9-44GMAX-0200

ISO	V _c [m/min]	d, [mm]											
		3	4	5	6	8	10	12	14	16	18	20	
		fz [mm]	fz [mm]	fz [mm]	fz [mm]	fz [mm]	fz [mm]	fz [mm]	fz [mm]	fz [mm]	fz [mm]	fz [mm]	fz [mm]
P	P1-P4	150-200	0,025	0,025	0,030	0,040	0,050	0,060	0,070	0,075	0,080	0,085	0,090
	P5-P12	120-160	0,025	0,025	0,030	0,035	0,050	0,055	0,060	0,065	0,070	0,075	0,080
	P13	70-130	0,025	0,025	0,030	0,030	0,045	0,045	0,050	0,055	0,060	0,065	0,070
	P14	70-110	0,015	0,015	0,025	0,030	0,045	0,045	0,050	0,055	0,060	0,065	0,070
M	M1	80-110	0,020	0,020	0,025	0,030	0,045	0,045	0,050	0,055	0,060	0,065	0,070
	M2-M3	60-90	0,020	0,020	0,025	0,040	0,045	0,050	0,055	0,060	0,065	0,070	0,075
K	K1-K5	140-200	0,025	0,025	0,030	0,040	0,060	0,060	0,070	0,075	0,080	0,085	0,090
N	N1-N5	240-280	0,035	0,040	0,050	0,050	0,055	0,065	0,075	0,080	0,085	0,090	0,095
	N7-N10	260-300	0,030	0,035	0,045	0,050	0,055	0,060	0,070	0,075	0,080	0,085	0,090
S	S3-S5	30-50	0,010	0,010	0,010	0,015	0,025	0,025	0,040	0,045	0,050	0,055	0,060
	S6-S8	40-70	0,010	0,010	0,015	0,020	0,030	0,030	0,040	0,045	0,050	0,060	0,065

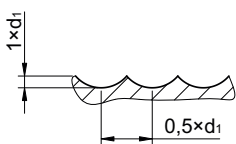

For machining steel and cast iron with hardness up to 45 HRC, stainless steel and difficult to machine materials					MASTERMILL 645										
Z=6 λ 44°-46° VHM TS 															
Workpiece material					<table border="1"> <tr> <td>P</td><td>M</td><td>K</td> </tr> <tr> <td>N</td><td>S</td><td>H</td> </tr> </table>					P	M	K	N	S	H
P	M	K													
N	S	H													
Shank															
Tool material					VHM										
Coating					TS										
Corner type															
d ₁	d ₂ h6	l ₁	l ₂	Z	INDEX										
6	6	57	16	6	M9-64GM00-0060										
8	8	63	20	6	M9-64GM00-0080										
10	10	72	25	6	M9-64GM00-0100										
12	12	83	30	6	M9-64GM00-0120										
14	14	83	35	6	M9-64GM00-0140										
16	16	92	40	6	M9-64GM00-0160										
20	20	104	45	6	M9-64GM00-0200										

ISO	V _c [m/min]	d ₁ [mm]							
		6	8	10	12	14	16	20	
		fz [mm]	fz [mm]	fz [mm]	fz [mm]	fz [mm]	fz [mm]	fz [mm]	
P	P1-P4	170-220	0,015	0,020	0,025	0,030	0,035	0,040	0,050
	P5-P12	160-190	0,010	0,020	0,020	0,030	0,030	0,040	0,050
	P13	120-150	0,010	0,010	0,020	0,025	0,030	0,030	0,040
	P14	80-130	0,010	0,010	0,020	0,025	0,030	0,030	0,040
M	M1	90-120	0,010	0,010	0,020	0,025	0,030	0,030	0,040
	M2-M3	80-100	0,015	0,020	0,035	0,040	0,045	0,045	0,055
K	K1-K6	105-135	0,015	0,020	0,025	0,030	0,030	0,035	0,045
N	N1-N5	200-250	0,015	0,020	0,025	0,030	0,035	0,040	0,045
	N7-N10	150-200	0,010	0,010	0,020	0,025	0,030	0,030	0,040
S	S3-S5	40-70	0,015	0,025	0,025	0,040	0,045	0,050	0,060
	S6-S8	60-90	0,020	0,030	0,030	0,040	0,045	0,050	0,065

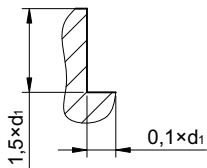

MASTERMILL

7



For machining steel and cast iron with hardness up to 35 HRC					X-MILL												
					230												
Z=2 λ 30° VHM AT 																	
Workpiece material																	
Shank																	
Tool material					VHM												
Coating					AT												
Corner type																	
d ₁	d ₂ h6	l ₁	l ₂	Z	INDEX												
1	4	50	3	2	M9-234X00-0010												
1,5	4	50	4	2	M9-234X00-0015												
2	4	50	6	2	M9-234X00-0020												
2,5	4	50	8	2	M9-234X00-0025												
3	4	50	8	2	M9-234X00-0030												
4	4	50	14	2	M9-234X00-0040												
5	6	50	16	2	M9-234X00-0050												
6	6	50	19	2	M9-234X00-0060												
7	8	58	19	2	M9-234X00-0070												
8	8	58	20	2	M9-234X00-0080												
9	10	72	22	2	M9-234X00-0090												
10	10	72	25	2	M9-234X00-0100												
11	12	73	25	2	M9-234X00-0110												
12	12	73	30	2	M9-234X00-0120												
14	14	83	35	2	M9-234X00-0140												
16	16	92	40	2	M9-234X00-0160												
18	18	100	45	2	M9-234X00-0180												
20	20	104	45	2	M9-234X00-0200												

ISO	V _c [m/min]	d ₁ [mm]															
		1	1,5	2	2,5	3	4	5	6-7	8-9	10-11	12	14	16	18	20	
		fz [mm]	fz [mm]	fz [mm]	fz [mm]	fz [mm]	fz [mm]	fz [mm]	fz [mm]	fz [mm]	fz [mm]	fz [mm]	fz [mm]	fz [mm]	fz [mm]	fz [mm]	
P	P1-P5	70-110	0,002	0,005	0,005	0,010	0,015	0,025	0,035	0,040	0,050	0,070	0,090	0,090	0,110	0,120	0,130
	P6-P12	50-80	0,002	0,004	0,005	0,050	0,010	0,015	0,025	0,030	0,035	0,050	0,060	0,065	0,080	0,085	0,090
	P13-P14	60-90	0,005	0,005	0,007	0,010	0,010	0,010	0,010	0,010	0,015	0,020	0,025	0,030	0,030	0,035	0,035
K	K1-K4	90-110	0,003	0,005	0,010	0,015	0,020	0,030	0,035	0,035	0,040	0,050	0,060	0,065	0,080	0,085	0,090
	K5-K6	80-90	0,003	0,005	0,010	0,015	0,020	0,030	0,035	0,035	0,040	0,050	0,060	0,065	0,080	0,085	0,090
N	N7-N9	150-170	0,005	0,005	0,010	0,010	0,010	0,015	0,015	0,025	0,030	0,035	0,045	0,050	0,055	0,090	0,100

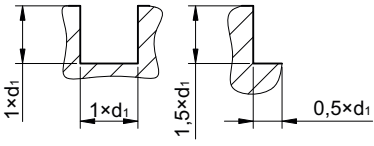

Another tool dimensions available on request

For machining steel and cast iron with hardness up to 35 HRC					X-MILL	
					230L	
Workpiece material						
Shank						
Tool material					VHM	
Coating					AT	
Corner type						
d₁	d₂h6	l₁	l₂	Z	INDEX	
6	6	75	15	2	M9-234X20-0060	
6	6	100	15	2	M9-234X20-0060A	
8	8	100	20	2	M9-234X20-0080	
10	10	100	25	2	M9-234X20-0100	
10	10	150	25	2	M9-234X20-0100A	
12	12	100	30	2	M9-234X20-0120	
12	12	150	30	2	M9-234X20-0120A	

ISO	V _c [m/min]	d ₁ [mm]				
		6	8	10	12	
		fz [mm]	fz [mm]	fz [mm]	fz [mm]	
P	P1-P5	60-90	0,030	0,040	0,055	0,065
	P6-P14	50-80	0,010	0,015	0,020	0,025
K	K1-K4	80-100	0,030	0,030	0,040	0,045
	K5-K6	80-90	0,030	0,030	0,040	0,045
N	N7-N9	150-170	0,020	0,025	0,030	0,040

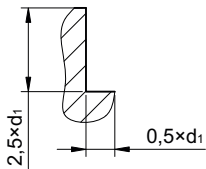

For machining steel and cast iron with hardness up to 35 HRC					X-MILL
					B230
Workpiece material					
Shank					
Tool material					VHM
Coating					AT
Corner type					
d_1	d_2 h6	l_1	l_2	Z	INDEX
1	4	50	2	2	M9-234X0X-0010
1,5	4	50	3	2	M9-234X0X-0015
2	4	50	4	2	M9-234X0X-0020
2,5	4	50	5	2	M9-234X0X-0025
3	4	50	6	2	M9-234X0X-0030
4	4	50	8	2	M9-234X0X-0040
5	6	50	10	2	M9-234X0X-0050
6	6	50	12	2	M9-234X0X-0060
8	8	58	16	2	M9-234X0X-0080
10	10	72	20	2	M9-234X0X-0100
12	12	73	24	2	M9-234X0X-0120
16	16	92	32	2	M9-234X0X-0160
18	18	100	40	2	M9-234X0X-0180
20	20	104	40	2	M9-234X0X-0200

ISO	Vc [m/min]	d_1 [mm]														
		1	1,5	2	2,5	3	4	5	6	8	10	12	16	18	20	
P	P1-P5	70-110	0,002	0,005	0,005	0,010	0,015	0,020	0,035	0,040	0,050	0,070	0,085	0,110	0,120	0,130
	P6-P12	50-80	0,002	0,005	0,005	0,005	0,010	0,015	0,025	0,030	0,035	0,050	0,060	0,080	0,085	0,090
K	K1-K4	90-110	0,003	0,005	0,010	0,015	0,020	0,030	0,035	0,035	0,035	0,050	0,060	0,070	0,075	0,080
	K5-K6	80-90	0,003	0,005	0,010	0,015	0,020	0,030	0,035	0,035	0,035	0,045	0,045	0,055	0,055	0,070
N	N7-N9	150-170	0,005	0,010	0,015	0,025	0,030	0,035	0,040	0,045	0,045	0,050	0,060	0,070	0,080	0,090

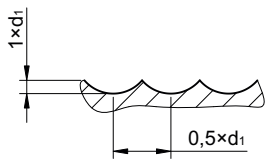

For machining steel and cast iron with hardness up to 35 HRC					X-MILL		
					B230L		
Workpiece material							
Shank							
Tool material					VHM		
Coating					AT		
Corner type							
d_1	d_2 h6	l_1	l_2	Z	INDEX		
6	6	75	12	2	M9-234X2X-0060		
6	6	100	12	2	M9-234X2X-0060A		
8	8	100	16	2	M9-234X2X-0080		
10	10	100	20	2	M9-234X2X-0100		
10	10	150	20	2	M9-234X2X-0100A		
12	12	100	24	2	M9-234X2X-0120		
12	12	150	24	2	M9-234X2X-0120A		
16	16	150	32	2	M9-234X2X-0160		

ISO	Vc [m/min]	d_1 [mm]						
		6	8	10	12	14	16	
		fz [mm]	fz [mm]	fz [mm]	fz [mm]	fz [mm]	fz [mm]	
P	P1-P5	70-110	0,040	0,050	0,070	0,085	0,090	0,110
	P6-P12	50-80	0,030	0,035	0,050	0,060	0,065	0,080
K	K1-K4	90-110	0,035	0,035	0,050	0,060	0,065	0,070
	K5-K6	80-90	0,035	0,035	0,045	0,045	0,050	0,055
N	N7-N9	150-170	0,045	0,045	0,050	0,060	0,065	0,070

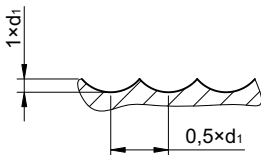

For machining steel, stainless steel and cast iron with hardness up to 35 HRC							X-MILL			
							345	345	R345	R345
Workpiece material										
Shank										
Tool material							VHM			
Coating							AT			
Corner type										
d ₁	d ₂ h6	l ₁	l ₂	Z	R	INDEX				
3	6	57	8	3	0,3	M9-344X00-0030	M9-344X00-0030-B	M9-344X0D-0030	M9-344X0D-0030-B	
4	6	57	11	3	0,3	M9-344X00-0040	M9-344X00-0040-B	M9-344X0D-0040	M9-344X0D-0040-B	
5	6	57	13	3	0,3	M9-344X00-0050	M9-344X00-0050-B	M9-344X0D-0050	M9-344X0D-0050-B	
6	6	57	13	3	0,5	M9-344X00-0060	M9-344X00-0060-B	M9-344X01-0060	M9-344X01-0060-B	
8	8	63	19	3	0,5	M9-344X00-0080	M9-344X00-0080-B	M9-344X01-0080	M9-344X01-0080-B	
8	8	63	19	3	1,0	-	-	M9-344X03-0080	M9-344X03-0080-B	
8	8	63	19	3	1,5	-	-	M9-344X04-0080	M9-344X04-0080-B	
10	10	72	22	3	0,5	M9-344X00-0100	M9-344X00-0100-B	M9-344X01-0100	M9-344X01-0100-B	
10	10	72	22	3	2,0	-	-	M9-344X05-0100	M9-344X05-0100-B	
12	12	83	26	3	0,7	M9-344X00-0120	M9-344X00-0120-B	M9-344X02-0120	M9-344X02-0120-B	
12	12	83	26	3	2,0	-	-	M9-344X05-0120	M9-344X05-0120-B	
14	14	83	26	3	0,7	M9-344X00-0140	M9-344X00-0140-B	M9-344X02-0140	M9-344X02-0140-B	
16	16	92	32	3	1,0	M9-344X00-0160	M9-344X00-0160-B	M9-344X03-0160	M9-344X03-0160-B	

ISO	V _c [m/min]	d ₁ [mm]									
		3	4	5	6	8	10	12	14	16	
		fz [mm]	fz [mm]	fz [mm]	fz [mm]	fz [mm]	fz [mm]	fz [mm]	fz [mm]	fz [mm]	
P	P1-P5	130-160	0,010	0,015	0,025	0,030	0,050	0,060	0,075	0,080	0,085
	P6-P9	80-110	0,010	0,015	0,020	0,025	0,040	0,045	0,055	0,060	0,065
	P10-P12	60-80	0,010	0,015	0,020	0,025	0,040	0,045	0,055	0,060	0,065
	P13	90-140	0,010	0,015	0,020	0,025	0,040	0,045	0,055	0,060	0,065
	P14	90-140	0,005	0,010	0,015	0,020	0,030	0,040	0,045	0,050	0,055
M	M1	90-140	0,010	0,015	0,020	0,025	0,040	0,050	0,060	0,065	0,070
	M2-M3	60-90	0,005	0,010	0,015	0,020	0,030	0,040	0,045	0,050	0,055
K	K1-K6	90-130	0,005	0,010	0,020	0,025	0,040	0,045	0,050	0,055	0,060
N	N1-N5	240-280	0,035	0,040	0,050	0,050	0,055	0,065	0,075	0,080	0,085
	N7-N10	260-300	0,030	0,035	0,045	0,050	0,055	0,060	0,070	0,075	0,080
S	S1,S3	15-25	0,005	0,010	0,015	0,020	0,025	0,035	0,040	0,045	0,050
	S2,S4-S5	10-20	0,005	0,010	0,010	0,015	0,020	0,025	0,030	0,035	0,040
	S6	40-60	0,010	0,015	0,015	0,020	0,025	0,030	0,040	0,045	0,050
	S7-S8	15-20	0,010	0,015	0,015	0,020	0,025	0,030	0,040	0,045	0,050

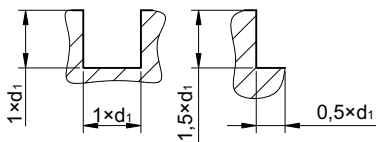

For machining steel, stainless steel and cast iron with hardness up to 35 HRC							X-MILL			
							440S	440S	R440S	R440S
<p>Version without corner radius is protected by corner chamfer: for $\varnothing < 6\text{mm}$ $f_1 = 0,1 \times 45^\circ$ for $\varnothing \geq 6\text{mm}$ $f_1 = 0,2 \times 45^\circ$</p>										
Workpiece material										
Shank										
Tool material							VHM	VHM	VHM	VHM
Coating							AT	AT	AT	AT
Corner type										
d_1	$d_2\text{h6}$	l_1	l_2	Z	R	INDEX				
3	6	54	7	4	0,3	M9-444X10-0030	M9-444X10-0030-B	M9-444X1D-0030	M9-444X1D-0030-B	
4	6	54	8	4	0,3	M9-444X10-0040	M9-444X10-0040-B	M9-444X1D-0040	M9-444X1D-0040-B	
5	6	54	10	4	0,3	M9-444X10-0050	M9-444X10-0050-B	M9-444X1D-0050	M9-444X1D-0050-B	
6	6	54	10	4	0,5	M9-444X10-0060	M9-444X10-0060-B	M9-444X11-0060	M9-444X11-0060-B	
8	8	58	12	4	0,5	M9-444X10-0080	M9-444X10-0080-B	M9-444X11-0080	M9-444X11-0080-B	
8	8	58	12	4	1,0	-	-	M9-444X13-0080	M9-444X13-0080-B	
10	10	66	14	4	0,5	M9-444X10-0100	M9-444X10-0100-B	M9-444X11-0100	M9-444X11-0100-B	
10	10	66	14	4	1,0	-	-	M9-444X13-0100	M9-444X13-0100-B	
10	10	66	14	4	1,5	-	-	M9-444X14-0100	M9-444X14-0100-B	
12	12	73	16	4	0,5	M9-444X10-0120	M9-444X10-0120-B	M9-444X11-0120	M9-444X11-0120-B	
12	12	73	16	4	0,7	-	-	M9-444X12-0120	M9-444X12-0120-B	
12	12	73	16	4	1,0	-	-	M9-444X13-0120	M9-444X13-0120-B	
14	14	75	18	4	0,5	M9-444X10-0140	M9-444X10-0140-B	M9-444X11-0140	M9-444X11-0140-B	
16	16	82	22	4	0,5	M9-444X10-0160	M9-444X10-0160-B	M9-444X11-0160	M9-444X11-0160-B	
16	16	82	22	4	1,0	-	-	M9-444X13-0160	M9-444X13-0160-B	
16	16	82	22	4	2,0	-	-	M9-444X15-0160	M9-444X15-0160-B	
20	20	92	26	4	1,0	M9-444X10-0200	M9-444X10-0200-B	M9-444X13-0200	M9-444X13-0200-B	

X-MILL

7

ISO	V_c [m/min]	d_1 [mm]										
		3	4	5	6	8	10	12	14	16	20	
		f_z [mm]	f_z [mm]	f_z [mm]	f_z [mm]	f_z [mm]	f_z [mm]	f_z [mm]	f_z [mm]	f_z [mm]	f_z [mm]	
P	P1-P7	130-160	0,005	0,010	0,015	0,020	0,030	0,045	0,055	0,060	0,065	0,080
	P8-P13	60-110	0,005	0,010	0,010	0,015	0,025	0,040	0,045	0,050	0,055	0,065
	P14	90-140	0,005	0,005	0,010	0,015	0,020	0,035	0,040	0,045	0,045	0,055
M	M1	90-140	0,005	0,005	0,010	0,015	0,020	0,035	0,040	0,045	0,045	0,055
	M2	60-90	0,005	0,010	0,010	0,015	0,025	0,040	0,045	0,050	0,055	0,065
	M3	60-80	0,005	0,005	0,010	0,015	0,020	0,035	0,040	0,045	0,045	0,055
K	K1-K6	90-130	0,005	0,010	0,020	0,025	0,030	0,040	0,045	0,050	0,055	0,065
N	N1-N5	240-280	0,035	0,040	0,045	0,050	0,055	0,065	0,075	0,080	0,085	0,095
	N7-N10	260-300	0,030	0,035	0,045	0,050	0,055	0,060	0,070	0,075	0,080	0,090
S	S1-S5	15-25	0,005	0,005	0,010	0,020	0,030	0,050	0,055	0,060	0,065	0,080
	S6-S8	40-60	0,005	0,010	0,015	0,020	0,035	0,050	0,055	0,060	0,065	0,080

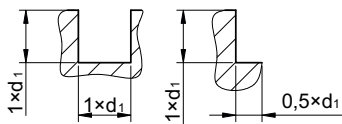

R - for tools with corner radius

Another tool dimensions available on request

For machining steel, stainless steel and cast iron with hardness up to 35 HRC

X-MILL

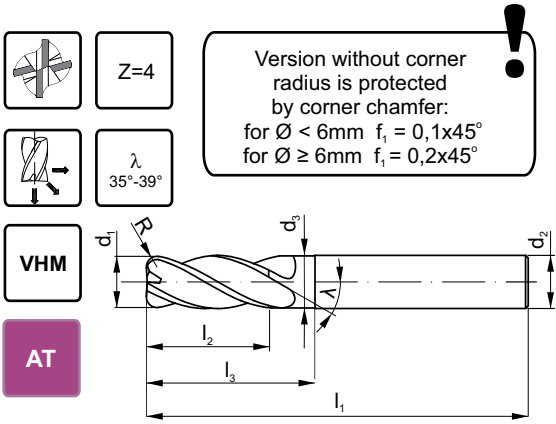

440N 440N R440N R440N



Workpiece material				
Shank				
Tool material	VHM	VHM	VHM	VHM
Coating	AT	AT	AT	AT
Corner type				

d ₁	d ₂ h6	d ₃	l ₁	l ₂	l ₃	Z	R	INDEX				
1	4	-	50	3	-	4	-	M9-444XA0-0010	-	-	-	-
1,5	4	-	50	4	-	4	-	M9-444XA0-0015	-	-	-	-
2,0	4	-	50	6	-	4	-	M9-444XA0-0020	-	-	-	-
2,5	4	-	50	8	-	4	-	M9-444XA0-0025	-	-	-	-
3	6	-	57	8	-	4	0,3	M9-444XA0-0030	M9-444XA0-0030-B	M9-444XAD-0030	M9-444XAD-0030-B	
4	6	-	57	11	-	4	0,3	M9-444XA0-0040	M9-444XA0-0040-B	M9-444XAD-0040	M9-444XAD-0040-B	
5	6	-	57	13	-	4	0,3	M9-444XA0-0050	M9-444XA0-0050-B	M9-444XAD-0050	M9-444XAD-0050-B	
6	6	5,5	57	13	21	4	0,5	M9-444XA0-0060	M9-444XA0-0060-B	M9-444XA1-0060	M9-444XA1-0060-B	
6	6	5,5	57	13	21	4	1,0	-	-	M9-444XA3-0060	M9-444XA3-0060-B	
8	8	7,5	63	19	27	4	0,5	M9-444XA0-0080	M9-444XA0-0080-B	M9-444XA1-0080	M9-444XA1-0080-B	
8	8	7,5	63	19	27	4	1,0	-	-	M9-444XA3-0080	M9-444XA3-0080-B	
8	8	7,5	63	19	27	4	2,0	-	-	M9-444XA5-0080	M9-444XA5-0080-B	
10	10	9,2	72	22	32	4	0,5	M9-444XA0-0100	M9-444XA0-0100-B	M9-444XA1-0100	M9-444XA1-0100-B	
10	10	9,2	72	22	32	4	1,0	-	-	M9-444XA3-0100	M9-444XA3-0100-B	
10	10	9,2	72	22	32	4	2,0	-	-	M9-444XA5-0100	M9-444XA5-0100-B	

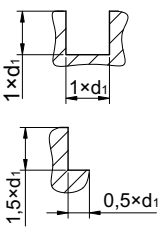

ISO	V _c [m/min]	d ₁ < 3 mm												
		1		1,5		2		2,5						
		fz [mm]	fz [mm]	fz [mm]	fz [mm]	fz [mm]	fz [mm]	fz [mm]	fz [mm]	fz [mm]	fz [mm]	fz [mm]	fz [mm]	
P	P1-P5	75	0,004	0,008	0,015	0,015								
	P6-P12	60	0,003	0,006	0,010	0,010								
K	K1-K4	100	0,003	0,006	0,010	0,015								
	K5-K6	85	0,003	0,006	0,010	0,020	0,025							
N	N7-N9	170	0,005	0,010	0,015	0,020	0,025							
P	P1-P7	130-160	0,005	0,010	0,015	0,020	0,030	0,045	0,055	0,060	0,065	0,070	0,080	0,095
	P8-P13	60-110	0,005	0,010	0,010	0,015	0,025	0,040	0,045	0,050	0,055	0,060	0,065	0,080
	P14	90-140	0,005	0,005	0,010	0,015	0,020	0,035	0,040	0,045	0,045	0,050	0,055	0,065
M	M1	80-120	0,005	0,005	0,010	0,015	0,020	0,035	0,040	0,045	0,045	0,050	0,055	0,065
	M2	60-90	0,005	0,010	0,010	0,015	0,025	0,040	0,045	0,050	0,055	0,060	0,065	0,080
	M3	60-80	0,005	0,005	0,010	0,015	0,020	0,035	0,040	0,045	0,045	0,050	0,055	0,065
K	K1-K6	90-130	0,005	0,010	0,020	0,025	0,030	0,040	0,045	0,050	0,055	0,060	0,065	0,080
N	N1-N5	240-280	0,035	0,040	0,050	0,050	0,055	0,065	0,075	0,080	0,085	0,090	0,095	0,105
	N7-N10	260-300	0,030	0,035	0,045	0,050	0,055	0,060	0,070	0,075	0,080	0,085	0,090	0,105
S	S1-S5	15-25	0,005	0,005	0,010	0,020	0,030	0,050	0,055	0,060	0,065	0,070	0,080	0,095
	S6-S8	40-60	0,005	0,005	0,015	0,020	0,035	0,050	0,055	0,060	0,065	0,070	0,080	0,095

For machining steel, stainless steel and cast iron with hardness up to 35 HRC								X-MILL					
								440N	440N	R440N	R440N		
Workpiece material													
Shank													
Tool material								VHM					
Coating								AT					
Corner type													
d ₁	d ₂ h6	d ₃	l ₁	l ₂	l ₃	Z	R	INDEX					
12	12	11	83	26	38	4	0,5	M9-444XA0-0120	M9-444XA0-0120-B	M9-444XA1-0120	M9-444XA1-0120-B		
12	12	11	83	26	38	4	0,7	-	-	M9-444XA2-0120	M9-444XA2-0120-B		
12	12	11	83	26	38	4	1,0	-	-	M9-444XA3-0120	M9-444XA3-0120-B		
12	12	11	83	26	38	4	1,5	-	-	M9-444XA4-0120	M9-444XA4-0120-B		
12	12	11	83	26	38	4	2,0	-	-	M9-444XA5-0120	M9-444XA5-0120-B		
12	12	11	83	26	38	4	3,0	-	-	M9-444XA7-0120	M9-444XA7-0120-B		
14	14	13	83	26	38	4	0,5	M9-444XA0-0140	M9-444XA0-0140-B	M9-444XA1-0140	M9-444XA1-0140-B		
14	14	13	83	26	38	4	0,7	-	-	M9-444XA2-0140	M9-444XA2-0140-B		
14	14	13	83	26	38	4	1,0	-	-	M9-444XA3-0140	M9-444XA3-0140-B		
14	14	13	83	26	38	4	2,0	-	-	M9-444XA5-0140	M9-444XA5-0140-B		
16	16	15	92	32	44	4	0,5	M9-444XA0-0160	M9-444XA0-0160-B	M9-444XA1-0160	M9-444XA1-0160-B		
16	16	15	92	32	44	4	1,0	-	-	M9-444XA3-0160	M9-444XA3-0160-B		
16	16	15	92	32	44	4	2,0	-	-	M9-444XA5-0160	M9-444XA5-0160-B		
16	16	15	92	32	44	4	3,0	-	-	M9-444XA7-0160	M9-444XA7-0160-B		
18	18	17	92	32	44	4	1,0	M9-444XA0-0180	M9-444XA0-0180-B	M9-444XA3-0180	M9-444XA3-0180-B		
20	20	19	104	38	55	4	1,0	M9-444XA0-0200	M9-444XA0-0200-B	M9-444XA3-0200	M9-444XA3-0200-B		
20	20	19	104	45	55	4	1,0	M9-444XA0-0200A	M9-444XA0-0200A-B	M9-444XA3-0200A	M9-444XA3-0200A-B		
20	20	19	104	45	55	4	2,0	-	-	M9-444XA5-0200A	M9-444XA5-0200A-B		
25	25	24	122	55	66	4	1,0	M9-444XA0-0250	M9-444XA0-0250-B	M9-444XA3-0250	M9-444XA3-0250-B		

X-MILL

7



ISO	V _c [m/min]	d, [mm]												
		3	4	5	6	8	10	12	14	16	18	20	25	
		fz [mm]	fz [mm]	fz [mm]	fz [mm]	fz [mm]	fz [mm]	fz [mm]	fz [mm]	fz [mm]	fz [mm]	fz [mm]	fz [mm]	
P	P1-P7	130-160	0,005	0,010	0,015	0,020	0,030	0,045	0,055	0,060	0,065	0,070	0,080	0,095
	P8-P13	60-110	0,005	0,010	0,010	0,015	0,025	0,040	0,045	0,050	0,055	0,060	0,065	0,080
	P14	90-140	0,005	0,005	0,010	0,015	0,020	0,035	0,040	0,045	0,045	0,050	0,055	0,065
M	M1	80-120	0,005	0,005	0,010	0,015	0,020	0,035	0,040	0,045	0,045	0,050	0,055	0,065
	M2	60-90	0,005	0,010	0,010	0,015	0,025	0,040	0,045	0,050	0,055	0,060	0,065	0,080
	M3	60-80	0,005	0,005	0,010	0,015	0,020	0,035	0,040	0,045	0,045	0,050	0,055	0,065
K	K1-K6	90-130	0,005	0,010	0,020	0,025	0,030	0,040	0,045	0,050	0,055	0,060	0,065	0,080
N	N1-N5	240-280	0,035	0,040	0,050	0,050	0,055	0,065	0,075	0,080	0,085	0,090	0,095	0,105
	N7-N10	260-300	0,030	0,035	0,045	0,050	0,055	0,060	0,070	0,075	0,080	0,085	0,090	0,105
S	S1-S5	15-25	0,005	0,005	0,010	0,020	0,030	0,050	0,055	0,060	0,065	0,070	0,080	0,095
	S6-S8	40-60	0,005	0,005	0,015	0,020	0,035	0,050	0,055	0,060	0,065	0,070	0,080	0,095

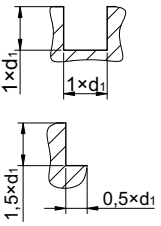

R - for tools with corner radius

Another tool dimensions available on request

For machining steel, stainless steel and cast iron with hardness up to 35 HRC

X-MILL

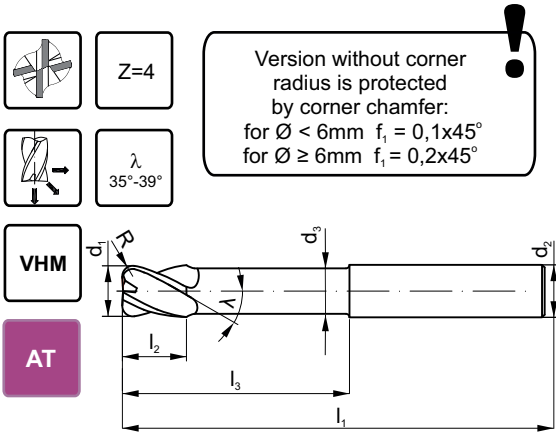

440NL 440NL R440NL R440NL



Workpiece material				
Shank				
Tool material	VHM	VHM	VHM	VHM
Coating	AT	AT	AT	AT
Corner type				

d ₁	d ₂ h6	d ₃	l ₁	l ₂	l ₃	Z	R	INDEX			
3	6	2,7	57	7	17	4	0,3	M9-444XG0-0030	M9-444XG0-0030-B	M9-444XGD-0030	M9-444XGD-0030-B
4	6	3,7	63	8	22	4	0,3	M9-444XG0-0040	M9-444XG0-0040-B	M9-444XGD-0040	M9-444XGD-0040-B
5	6	4,7	67	10	27	4	0,3	M9-444XG0-0050	M9-444XG0-0050-B	M9-444XGD-0050	M9-444XGD-0050-B
6	6	5,5	74	10	32	4	0,5	M9-444XG0-0060	M9-444XG0-0060-B	M9-444XG1-0060	M9-444XG1-0060-B
6	6	5,5	74	10	32	4	1,0	-	-	M9-444XG3-0060	M9-444XG3-0060-B
8	8	7,5	90	12	46	4	0,5	M9-444XG0-0080	M9-444XG0-0080-B	M9-444XG1-0080	M9-444XG1-0080-B
8	8	7,5	90	12	46	4	1,0	-	-	M9-444XG3-0080	M9-444XG3-0080-B
10	10	9,2	102	14	55	4	0,5	M9-444XG0-0100	M9-444XG0-0100-B	M9-444XG1-0100	M9-444XG1-0100-B
10	10	9,2	102	14	55	4	1,0	-	-	M9-444XG3-0100	M9-444XG3-0100-B
10	10	9,2	102	14	55	4	2,5	-	-	M9-444XG6-0100	M9-444XG6-0100-B
12	12	11	117	16	64	4	0,5	M9-444XG0-0120	M9-444XG0-0120-B	M9-444XG1-0120	M9-444XG1-0120-B
12	12	11	117	16	64	4	1,0	-	-	M9-444XG3-0120	M9-444XG3-0120-B
16	16	15	141	22	87	4	0,5	M9-444XG0-0160	M9-444XG0-0160-B	M9-444XG1-0160	M9-444XG1-0160-B
16	16	15	141	22	87	4	1,0	-	-	M9-444XG3-0160	M9-444XG3-0160-B
16	16	15	141	22	87	4	2,0	-	-	M9-444XG5-0160	M9-444XG5-0160-B
20	20	19	164	26	110	4	1,0	M9-444XG0-0200	M9-444XG0-0200-B	M9-444XG3-0200	M9-444XG3-0200-B

ISO	V _c [m/min]	d, [mm]										
		3	4	5	6	8	10	12	14	16	20	
P	P1-P7	130-160	0,005	0,010	0,015	0,020	0,030	0,045	0,055	0,060	0,065	0,080
	P8-P13	60-110	0,005	0,010	0,010	0,015	0,025	0,040	0,045	0,050	0,055	0,065
	P14	90-140	0,005	0,005	0,010	0,015	0,020	0,035	0,040	0,045	0,045	0,055
M	M1	75-90	0,005	0,005	0,010	0,015	0,020	0,035	0,040	0,045	0,045	0,055
	M2	60-70	0,005	0,010	0,010	0,015	0,025	0,040	0,045	0,050	0,055	0,065
	M3	45-55	0,005	0,005	0,010	0,015	0,025	0,035	0,040	0,045	0,045	0,055
K	K1-K6	90-130	0,005	0,010	0,020	0,025	0,030	0,040	0,045	0,050	0,055	0,065
N	N1-N5	240-280	0,035	0,040	0,050	0,050	0,055	0,065	0,075	0,080	0,085	0,095
	N7-N10	260-300	0,030	0,035	0,045	0,050	0,055	0,060	0,070	0,075	0,080	0,090
S	S1-S5	15-25	0,005	0,010	0,015	0,020	0,030	0,050	0,055	0,060	0,065	0,080
	S6-S8	40-60	0,005	0,010	0,015	0,020	0,035	0,050	0,055	0,060	0,650	0,075

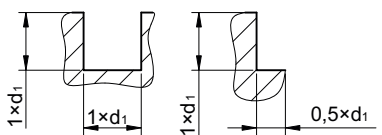

For machining steel and cast iron with hardness up to 35 HRC							X-MILL		
							430L	430L	R430L
Workpiece material									
Shank									
Tool material							VHM	VHM	VHM
Coating							AT	AT	AT
Corner type									
d ₁	d ₂ h6	l ₁	l ₂	Z	R	INDEX			
2	4	50	15	4	-	M9-434X20-0020	-	-	
3	4	50	20	4	0,3	M9-434X20-0030	-	M9-434X2D-0030	
4	4	75	25	4	0,3	M9-434X20-0040	-	M9-434X2D-0040	
5	6	75	30	4	0,3	M9-434X20-0050	M9-434X20-0050-B	M9-434X2D-0050	
6	6	75	30	4	0,5	M9-434X20-0060	M9-434X20-0060-B	M9-434X21-0060	
8	8	100	40	4	0,5	M9-434X20-0080	M9-434X20-0080-B	M9-434X21-0080	
10	10	100	40	4	0,5	M9-434X20-0100	M9-434X20-0100-B	M9-434X21-0100	
12	12	100	45	4	0,7	M9-434X20-0120	M9-434X20-0120-B	M9-434X22-0120	
16	16	150	60	4	1,0	M9-434X20-0160	M9-434X20-0160-B	M9-434X23-0160	
20	20	150	60	4	1,0	M9-434X20-0200	M9-434X20-0200-B	M9-434X23-0200	

ISO	V _c [m/min]	d, [mm]										
		2	3	4	5	6	8	10	12	16	20	
P	P1-P5	50-65	0,010	0,015	0,020	0,030	0,040	0,060	0,075	0,085	0,100	0,110
	P6-P12	40-50	0,005	0,010	0,010	0,100	0,010	0,015	0,020	0,020	0,025	0,030
K	K1-K4	60-80	0,005	0,010	0,010	0,015	0,030	0,030	0,040	0,050	0,055	0,060
	K5-K6	50-70	0,005	0,010	0,010	0,015	0,030	0,030	0,040	0,050	0,055	0,060
N	N7-N9	90-140	0,015	0,025	0,030	0,030	0,035	0,040	0,050	0,060	0,075	0,090

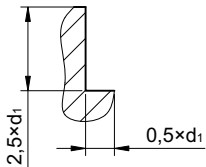

For machining steel, stainless steel and cast iron with hardness up to 35 HRC						X-MILL						
						B440						
Workpiece material												
Shank												
Tool material						VHM						
Coating						AT						
Corner type												
d_1	d_2 h6	l_1	l_2	Z	R	INDEX						
3	6	54	7	4	1,5	M9-444X1X-0030						
4	6	54	8	4	2,0	M9-444X1X-0040						
5	6	54	10	4	2,5	M9-444X1X-0050						
6	6	54	10	4	3,0	M9-444X1X-0060						
8	8	58	12	4	4,0	M9-444X1X-0080						
10	10	66	14	4	5,0	M9-444X1X-0100						
12	12	73	16	4	6,0	M9-444X1X-0120						
14	14	75	18	4	7,0	M9-444X1X-0140						
16	16	82	22	4	8,0	M9-444X1X-0160						
18	18	84	24	4	9,0	M9-444X1X-0180						
20	20	92	26	4	10,0	M9-444X1X-0200						

ISO	V_c [m/min]	d_1 [mm]											
		3	4	5	6	8	10	12	14	16	18	20	
		fz [mm]	fz [mm]	fz [mm]	fz [mm]	fz [mm]	fz [mm]	fz [mm]	fz [mm]	fz [mm]	fz [mm]	fz [mm]	fz [mm]
P	P1-P13	80-130	0,025	0,025	0,030	0,040	0,060	0,060	0,070	0,075	0,080	0,085	0,090
	P14	60-70	0,015	0,015	0,025	0,030	0,040	0,045	0,050	0,055	0,060	0,065	0,070
M	M1-M2	60-85	0,020	0,020	0,025	0,040	0,045	0,050	0,055	0,060	0,065	0,070	0,075
K	K1-K6	80-130	0,025	0,025	0,030	0,040	0,060	0,060	0,070	0,075	0,080	0,085	0,090
N	N1-N5	240-280	0,035	0,040	0,050	0,050	0,055	0,065	0,075	0,080	0,085	0,090	0,095
	N7-N10	260-300	0,030	0,035	0,045	0,050	0,055	0,060	0,070	0,075	0,080	0,085	0,090
S	S1-S5	20-30	0,010	0,010	0,010	0,015	0,025	0,025	0,040	0,045	0,050	0,055	0,060
	S6-S8	40-55	0,010	0,010	0,015	0,020	0,030	0,030	0,040	0,045	0,050	0,060	0,065

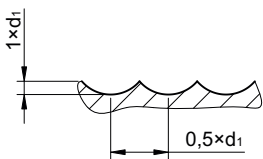

For machining steel, stainless steel and cast iron with hardness up to 35 HRC						X-MILL			
						540	540	R540	R540
Workpiece material									
Shank									
Tool material						VHM			
Coating						AT			
Corner type									
d ₁	d ₂ h6	l ₁	l ₂	Z	R	INDEX			
6	6	57	13	5	0,5	M9-544X00-0060	M9-544X00-0060-B	M9-544X01-0060	M9-544X01-0060-B
8	8	63	19	5	0,5	M9-544X00-0080	M9-544X00-0080-B	M9-544X01-0080	M9-544X01-0080-B
8	8	63	19	5	1,0	-	-	M9-544X03-0080	M9-544X03-0080-B
8	8	63	19	5	1,5	-	-	M9-544X04-0080	M9-544X04-0080-B
8	8	63	19	5	2,0	-	-	M9-544X05-0080	M9-544X05-0080-B
10	10	72	22	5	0,5	M9-544X00-0100	M9-544X00-0100-B	M9-544X01-0100	M9-544X01-0100-B
10	10	72	22	5	2,5	-	-	M9-544X06-0100	M9-544X06-0100-B
12	12	83	26	5	0,5	M9-544X00-0120	M9-544X00-0120-B	M9-544X01-0120	M9-544X01-0120-B
12	12	83	26	5	0,7	-	-	M9-544X02-0120	M9-544X02-0120-B
12	12	83	26	5	1,0	-	-	M9-544X03-0120	M9-544X03-0120-B
14	14	83	26	5	0,5	M9-544X00-0140	M9-544X00-0140-B	M9-544X01-0140	M9-544X01-0140-B
16	16	92	32	5	0,5	M9-544X00-0160	M9-544X00-0160-B	M9-544X01-0160	M9-544X01-0160-B
16	16	92	32	5	1,0	-	-	M9-544X03-0160	M9-544X03-0160-B
16	16	92	32	5	2,0	-	-	M9-544X05-0160	M9-544X05-0160-B
18	18	92	32	5	1,0	M9-544X00-0180	M9-544X00-0180-B	M9-544X03-0180	M9-544X03-0180-B
20	20	104	38	5	1,0	M9-544X00-0200	M9-544X00-0200-B	M9-544X03-0200	M9-544X03-0200-B

ISO	V _c [m/min]	d, [mm]									
		6	8	10	12	14	16	18	20		
P	P1-P13	130-150	0,035	0,040	0,050	0,065	0,070	0,075	0,080	0,090	
	P14	90-100	0,030	0,035	0,040	0,045	0,065	0,070	0,070	0,075	
M	M1-M2	70-100	0,030	0,035	0,040	0,045	0,065	0,070	0,070	0,075	
K	K1-K6	110-140	0,035	0,040	0,050	0,065	0,070	0,075	0,075	0,090	
N	N1-N5	240-280	0,050	0,055	0,065	0,075	0,080	0,085	0,085	0,095	
	N7-N10	260-300	0,050	0,055	0,060	0,070	0,075	0,080	0,085	0,090	
S	S1-S5	20-30	0,015	0,020	0,025	0,035	0,045	0,050	0,050	0,060	
	S6-S8	40-65	0,030	0,035	0,040	0,050	0,055	0,065	0,065	0,075	

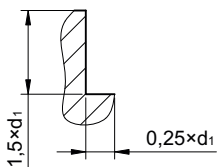

For roughing steel, cast iron, difficult to machine materials and non-ferrous materials

ZGR

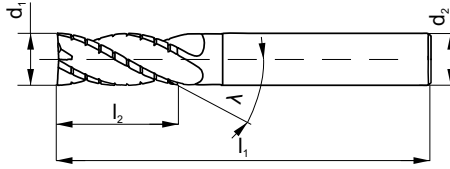
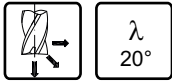

420

420



Workpiece material



Shank



Tool material

VHM

VHM

Coating

AT

AT

Corner type



d_1 d_2 h6 l_1 l_2 Z

INDEX

6	6	57	16	4	M9-424A00-0060	M9-424A00-0060-B
7	8	63	16	4	M9-424A00-0070	M9-424A00-0070-B
8	8	63	16	4	M9-424A00-0080	M9-424A00-0080-B
9	10	72	19	4	M9-424A00-0090	M9-424A00-0090-B
10	10	72	22	4	M9-424A00-0100	M9-424A00-0100-B
12	12	83	26	4	M9-424A00-0120	M9-424A00-0120-B
14	14	83	26	4	M9-424A00-0140	M9-424A00-0140-B
16	16	92	32	4	M9-424A00-0160	M9-424A00-0160-B
18	18	92	32	4	M9-424A00-0180	M9-424A00-0180-B
20	20	104	38	4	M9-424A00-0200	M9-424A00-0200-B

ISO	V_c [m/min]	d_1 [mm]								
		6	8	10	12	14	16	18	20	
P	P1-P8	100-140	0,030	0,035	0,035	0,045	0,050	0,055	0,060	0,070
	P9-P11	100-120	0,025	0,030	0,030	0,035	0,040	0,045	0,045	0,050
	P13-P14	50-65	0,015	0,020	0,020	0,025	0,030	0,035	0,035	0,040
M	M1-M3	40-60	0,015	0,020	0,020	0,025	0,030	0,035	0,035	0,040
K	K1-K2	110-160	0,030	0,035	0,045	0,050	0,055	0,056	0,060	0,070
	K3-K6	80-110	0,020	0,020	0,035	0,035	0,040	0,040	0,045	0,050
H	H1,H2,H4	50-90	0,020	0,020	0,035	0,030	0,035	0,035	0,040	0,040

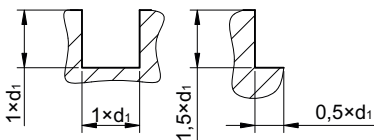

For roughing steel, cast iron, difficult to machine materials and non-ferrous materials								ZGR 440N / 540N / 640N	
Z=4-6 λ 45° VHM TS 									
Workpiece material									
Shank								VHM	
Tool material								TS	
Coating									
Corner type									
d ₁	d ₂ h6	d ₃	l ₁	l ₂	l ₃	Z	F	INDEX	
6	6	5,5	57	13	21	4	0,3	M9-44GAA0-0060	
8	8	7,5	63	19	27	4	0,4	M9-44GAA0-0080	
10	10	9,5	72	22	32	5	0,5	M9-54GAA0-0100	
12	12	11,5	83	26	38	5	0,6	M9-54GAA0-0120	
16	16	15	92	32	44	6	0,8	M9-64GAA0-0160	

ISO	V _c [m/min]	d ₁ [mm]					
		6	8	10	12	16	
		fz [mm]	fz [mm]	fz [mm]	fz [mm]	fz [mm]	
P	P1-P8	130-150	0,03	0,035	0,035	0,45	0,55
	P9-P11	90-120	0,025	0,03	0,03	0,035	0,045
	P13-P14	60-80	0,015	0,02	0,02	0,025	0,035
M	M1-M3	50-70	0,015	0,02	0,2	0,025	0,035
K	K1-K2	110-160	0,03	0,035	0,045	0,05	0,055
	K3-K6	80-110	0,02	0,02	0,035	0,035	0,04
H	H1,H2,H4	40-80	0,02	0,02	0,03	0,035	0,035

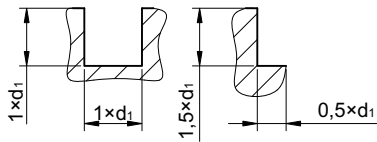

For high feed machining materials with hardness up to 55 HRC							HRC				
							HFM 200				
Workpiece material											
Shank											
Tool material							VHM				
Coating							AD				
Corner type											
d_1	d_2 h6	l_1	$a_{p_{max}}$	l_3	Z	R	INDEX				
6	6	57	0,30	20	2	0,6	M9-20E9A0-0060				
8	8	63	0,35	20	2	0,8	M9-20E9A0-0080				
10	10	72	0,40	30	2	1,0	M9-20E9A0-0100				
12	12	83	0,70	35	2	1,2	M9-20E9A0-0120				
16	16	92	0,80	50	2	1,6	M9-20E9A0-0160				
ISO	V_c [m/min]	a_e [mm]	d_1 [mm]								
			6	8	10	12	16				
			f_z [mm]	f_z [mm]	f_z [mm]	f_z [mm]	f_z [mm]				
P	P1-P5	300-350	0,4 - 0,6xD	0,4	0,5	0,6	0,8	1,2			
	P6-P14	200-250	0,4 - 0,6xD	0,3	0,4	0,5	0,6	1,0			
K	K1-K3	400-450	0,4 - 0,6xD	0,4	0,5	0,6	0,8	1,2			
	K4-K6	300-350	0,4 - 0,6xD	0,3	0,4	0,5	0,6	1,0			
H	H1-H4	70-120	0,2 - 0,4xD	0,3	0,4	0,5	0,6	1,0			



H - group materials may only be machined dry. For more information see p. 325 in Technical Information.

For hardened materials

Z=4

λ 15°

Dia Ø ≤ 5

VHM

TS

HRC

B415N

Workpiece material:

Shank:

Tool material: VHM

Coating: TS

Corner type:

d ₁	d ₂ h6	d ₃	l ₁	l ₂	l ₃	Z	R	INDEX
3	6	2,9	57	7	21	4	1,5	M9-41G9AX-0030
4	6	3,9	57	8	21	4	2,0	M9-41G9AX-0040
5	6	4,9	57	10	21	4	2,5	M9-41G9AX-0050
6	6	5,9	57	10	21	4	3,0	M9-41G9AX-0060
8	8	7,8	63	12	23	4	4,0	M9-41G9AX-0080
10	10	9,8	72	14	27	4	5,0	M9-41G9AX-0100
12	12	11,8	75	16	30	4	6,0	M9-41G9AX-0120
16	16	15,8	92	22	44	4	8,0	M9-41G9AX-0160

ISO	Vc [m/min]	d, [mm]								
		3	4	5	6	8	10	12	16	
		fz [mm]	fz [mm]	fz [mm]	fz [mm]	fz [mm]	fz [mm]	fz [mm]	fz [mm]	
H	H1	180-220	0,040	0,055	0,070	0,085	0,100	0,120	0,160	0,220
	H2, H4	140-180	0,030	0,035	0,055	0,065	0,080	0,100	0,150	0,175
	H3	115-160	0,025	0,035	0,045	0,055	0,065	0,085	0,100	0,150

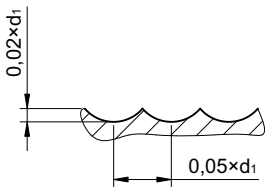

i H - group materials may only be machined dry. For more information see p. 325 in Technical Information.

Another tool dimensions available on request

For hardened materials						HRC						
						R645						
Z=6 λ 45° VHM TS 												
Workpiece material												
Shank												
Tool material						VHM						
Coating						TS						
Corner type												
d_1	d_2 h6	l_1	l_2	Z	R	INDEX						
6	6	57	13	6	0,5	M9-64G901-0060						
8	8	63	19	6	0,5	M9-64G901-0080						
10	10	72	22	6	1,0	M9-64G903-0100						
12	12	75	26	6	1,0	M9-64G903-0120						
16	16	92	32	6	1,5	M9-64G904-0160						
ISO	V_c [m/min]	d_1 [mm]										
		6	8	10	12	16						
H	H1	80-140	fz [mm]	fz [mm]	fz [mm]	fz [mm]	fz [mm]	0,035	0,050	0,060	0,070	0,085
	H2-H4	50-80	0,025	0,035	0,045	0,050	0,065					

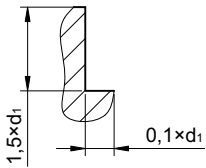

H - group materials may only be machined dry. For more information see p. 325 in Technical Information.

For machining aluminium alloys and other non-ferrous materials					AL								
					130								
Workpiece material					<table border="1"> <tr><td>P</td><td>M</td><td>K</td></tr> <tr><td>N</td><td>S</td><td>H</td></tr> </table>			P	M	K	N	S	H
P	M	K											
N	S	H											
Shank													
Tool material					VHM								
Coating					-								
Corner type													
d_1	d_2, h_6	l_1	l_2	Z	INDEX								
3	6	57	12	1	M9-131700-0030								
4	6	57	12	1	M9-131700-0040								
5	6	57	14	1	M9-131700-0050								
6	6	57	16	1	M9-131700-0060								
8	8	63	20	1	M9-131700-0080								
10	10	72	22	1	M9-131700-0100								
ISO	V_c [m/min]	d_1 [mm]											
		3	4	5	6	8	10						
N	N1-N2	250-400	fz [mm]	fz [mm]	fz [mm]	fz [mm]	fz [mm]	fz [mm]					
	N3-N5	290-440	0,010	0,015	0,020	0,025	0,030	0,035					
	N7-N9	210-360	0,010	0,015	0,020	0,025	0,030	0,035					
			0,005	0,010	0,015	0,020	0,025	0,030					

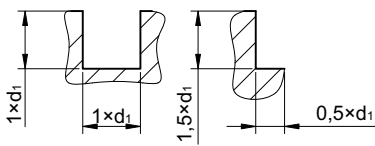

For machining aluminium alloys and other non-ferrous materials						AL					
						245	245	R245	R245		
Workpiece material											
Shank											
Tool material						VHM		VHM		VHM	
Coating						-		-		-	
Corner type											
d ₁	d ₂	l ₁	l ₂	Z	R	INDEX					
3	3	39	12	2	0,3	M9-241700-0030	-	M9-24170D-0030	-	-	-
4	4	51	12	2	0,3	M9-241700-0040	-	M9-24170D-0040	-	-	-
5	5	51	14	2	0,3	M9-241700-0050	-	M9-24170D-0050	-	-	-
6	6	57	16	2	0,5	M9-241700-0060	M9-241700-0060-B	M9-241701-0060	M9-241701-0060-B	M9-241701-0060-B	M9-241701-0060-B
6	6	57	16	2	1	-	-	M9-241703-0060	M9-241703-0060-B	M9-241703-0060-B	M9-241703-0060-B
8	8	63	20	2	0,5	M9-241700-0080	M9-241700-0080-B	M9-241701-0080	M9-241701-0080-B	M9-241701-0080-B	M9-241701-0080-B
8	8	63	20	2	1	-	-	M9-241703-0080	M9-241703-0080-B	M9-241703-0080-B	M9-241703-0080-B
10	10	72	22	2	0,5	M9-241700-0100	M9-241700-0100-B	M9-241701-0100	M9-241701-0100-B	M9-241701-0100-B	M9-241701-0100-B
12	12	83	32	2	0,5	M9-241700-0120	M9-241700-0120-B	M9-241701-0120	M9-241701-0120-B	M9-241701-0120-B	M9-241701-0120-B
14	14	83	32	2	0,5	M9-241700-0140	M9-241700-0140-B	M9-241701-0140	M9-241701-0140-B	M9-241701-0140-B	M9-241701-0140-B
16	16	92	36	2	0,5	M9-241700-0160	M9-241700-0160-B	M9-241701-0160	M9-241701-0160-B	M9-241701-0160-B	M9-241701-0160-B
18	18	92	45	2	1	M9-241700-0180	M9-241700-0180-B	M9-241703-0180	M9-241703-0180-B	M9-241703-0180-B	M9-241703-0180-B
20	20	104	50	2	1	M9-241700-0200	M9-241700-0200-B	M9-241703-0200	M9-241703-0200-B	M9-241703-0200-B	M9-241703-0200-B

ISO	V _c [m/min]	d ₁ [mm]											
		3	4	5	6	8	10	12	14	16	18	20	
N	N1-N2	180-270	0,035	0,045	0,050	0,060	0,090	0,110	0,135	0,145	0,155	0,180	0,200
	N3-N4	380-480	0,045	0,055	0,065	0,080	0,150	0,160	0,170	0,200	0,230	0,250	0,270
	N7-N9	180-270	0,010	0,015	0,020	0,025	0,030	0,035	0,050	0,050	0,055	0,090	0,100

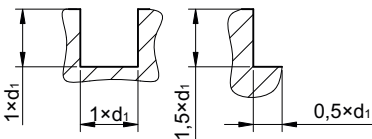

For machining aluminium alloys and other non-ferrous materials							AL			
							245	245	R245	R245
Workpiece material										
Shank										
Tool material							VHM			
Coating							TB			
Corner type										
d ₁	d ₂	l ₁	l ₂	Z	R	INDEX				
3	3	39	12	2	0,3	M9-24B700-0030	-	M9-24B70D-0030	-	
4	4	51	12	2	0,3	M9-24B700-0040	-	M9-24B70D-0040	-	
5	5	51	14	2	0,3	M9-24B700-0050	-	M9-24B70D-0050	-	
6	6	57	16	2	0,5	M9-24B700-0060	M9-24B700-0060-B	M9-24B701-0060	M9-24B701-0060-B	
6	6	57	16	2	1	-	-	M9-24B703-0060	M9-24B703-0060-B	
8	8	63	20	2	0,5	M9-24B700-0080	M9-24B700-0080-B	M9-24B701-0080	M9-24B701-0080-B	
8	8	63	20	2	1	-	-	M9-24B703-0080	M9-24B703-0080-B	
10	10	72	22	2	0,5	M9-24B700-0100	M9-24B700-0100-B	M9-24B701-0100	M9-24B701-0100-B	
12	12	83	32	2	0,5	M9-24B700-0120	M9-24B700-0120-B	M9-24B701-0120	M9-24B701-0120-B	
14	14	83	32	2	0,5	M9-24B700-0140	M9-24B700-0140-B	M9-24B701-0140	M9-24B701-0140-B	
16	16	92	36	2	0,5	M9-24B700-0160	M9-24B700-0160-B	M9-24B701-0160	M9-24B701-0160-B	
18	18	92	45	2	1	M9-24B700-0180	M9-24B700-0180-B	M9-24B703-0180	M9-24B703-0180-B	
20	20	104	50	2	1	M9-24B700-0200	M9-24B700-0200-B	M9-24B703-0200	M9-24B703-0200-B	

ISO	V _c [m/min]	d, [mm]											
		3	4	5	6	8	10	12	14	16	18	20	
N	N1-N2	180-270	0,035	0,045	0,050	0,060	0,090	0,110	0,135	0,145	0,155	0,180	0,200
	N3-N4	380-480	0,045	0,055	0,065	0,080	0,150	0,160	0,170	0,200	0,230	0,250	0,270
	N7-N9	180-270	0,010	0,015	0,020	0,025	0,030	0,035	0,050	0,050	0,055	0,090	0,100

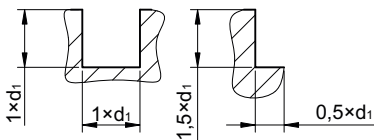

For machining aluminium alloys and other non-ferrous materials						AL				
						B245				
Workpiece material										
Shank										
Tool material						VHM				
Coating						TB				
Corner type										
d_1	d_2	l_1	l_2	Z	R	INDEX				
3	3	39	12	2	1,5	M9-24B70X-0030				
4	4	51	12	2	2	M9-24B70X-0040				
5	5	51	14	2	2,5	M9-24B70X-0050				
6	6	57	16	2	3	M9-24B70X-0060				
8	8	63	20	2	4	M9-24B70X-0080				
10	10	72	22	2	5	M9-24B70X-0100				
12	12	83	32	2	6	M9-24B70X-0120				
16	16	92	36	2	8	M9-24B70X-0160				

7

ISO	Vc [m/min]	d, [mm]								
		3	4	5	6	8	10	12	16	
		fz [mm]	fz [mm]	fz [mm]	fz [mm]	fz [mm]	fz [mm]	fz [mm]	fz [mm]	
N	N1-N4	230-350	0,030	0,035	0,040	0,050	0,070	0,085	0,110	0,175
	N7-N9	130-170	0,007	0,008	0,010	0,015	0,025	0,030	0,040	0,055

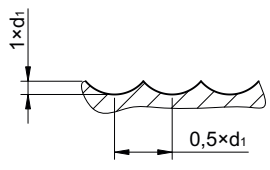

For machining aluminium alloys and other non-ferrous materials							AL						
							345	345	R345	R345			
Workpiece material													
Shank													
Tool material							VHM	VHM	VHM	VHM			
Coating							-	-	-	-			
Corner type													
d ₁	d ₂	l ₁	l ₂	Z	R	INDEX							
3	3	39	12	3	0,3	M9-341700-0030	-	M9-34170D-0030	-				
4	4	51	12	3	0,3	M9-341700-0040	-	M9-34170D-0040	-				
5	5	51	14	3	0,3	M9-341700-0050	-	M9-34170D-0050	-				
6	6	57	16	3	0,5	M9-341700-0060	M9-341700-0060-B	M9-341701-0060	M9-341701-0060-B				
6	6	57	16	3	1	-	-	M9-341703-0060	M9-341703-0060-B				
8	8	63	20	3	0,5	M9-341700-0080	M9-341700-0080-B	M9-341701-0080	M9-341701-0080-B				
8	8	63	20	3	1	-	-	M9-341703-0080	M9-341703-0080-B				
8	8	63	20	3	2	-	-	M9-341705-0080	M9-341705-0080-B				
10	10	72	22	3	0,5	M9-341700-0100	M9-341700-0100-B	M9-341701-0100	M9-341701-0100-B				
10	10	72	22	3	1	-	-	M9-341703-0100	M9-341703-0100-B				
10	10	72	22	3	1,5	-	-	M9-341704-0100	M9-341704-0100-B				
10	10	72	22	3	2	-	-	M9-341705-0100	M9-341705-0100-B				
10	10	72	22	3	2,5	-	-	M9-341706-0100	M9-341706-0100-B				
12	12	83	32	3	0,5	M9-341700-0120	M9-341700-0120-B	M9-341701-0120	M9-341701-0120-B				
12	12	83	32	3	1	-	-	M9-341703-0120	M9-341703-0120-B				
12	12	83	32	3	1,5	-	-	M9-341704-0120	M9-341704-0120-B				
12	12	83	32	3	2	-	-	M9-341705-0120	M9-341705-0120-B				
12	12	83	32	3	2,5	-	-	M9-341706-0120	M9-341706-0120-B				
12	12	83	32	3	3	-	-	M9-341707-0120	M9-341707-0120-B				
ISO	V _c [m/min]	d ₁ [mm]											
		3	4	5	6	8	10	12	14	16	18	20	
N	N1-N4	350-450	fz [mm]	fz [mm]	fz [mm]	fz [mm]	fz [mm]	fz [mm]	fz [mm]	fz [mm]	fz [mm]	fz [mm]	fz [mm]
	N7-N9	160-280	0,020	0,030	0,055	0,070	0,085	0,100	0,115	0,135	0,150	0,200	0,220
			0,020	0,030	0,040	0,550	0,070	0,090	0,095	0,105	0,120	0,140	0,150

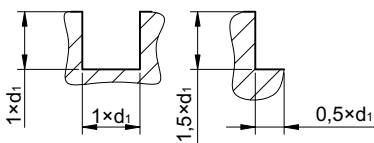

R - for tools with corner radius

Another tool dimensions available on request

For machining aluminium alloys and other non-ferrous materials							AL						
							345	345	R345	R345			
Workpiece material													
Shank													
Tool material							VHM	VHM	VHM	VHM			
Coating							-	-	-	-			
Corner type													
d ₁	d ₂	l ₁	l ₂	Z	R	INDEX							
14	14	83	32	3	0,5	M9-341700-0140	M9-341700-0140-B	M9-341701-0140	M9-341701-0140-B				
14	14	83	32	3	1	-	-	M9-341703-0140	M9-341703-0140-B				
16	16	92	36	3	0,5	M9-341700-0160	M9-341700-0160-B	M9-341701-0160	M9-341701-0160-B				
16	16	92	36	3	1	-	-	M9-341703-0160	M9-341703-0160-B				
16	16	92	36	3	2	-	-	M9-341705-0160	M9-341705-0160-B				
16	16	92	36	3	2,5	-	-	M9-341706-0160	M9-341706-0160-B				
16	16	92	36	3	3	-	-	M9-341707-0160	M9-341707-0160-B				
18	18	92	45	3	1	M9-341700-0180	M9-341700-0180-B	M9-341703-0180	M9-341703-0180-B				
20	20	104	50	3	1	M9-341700-0200	M9-341700-0200-B	M9-341703-0200	M9-341703-0200-B				
20	20	104	50	3	2	-	-	M9-341705-0200	M9-341705-0200-B				
20	20	104	50	3	3	-	-	M9-341707-0200	M9-341707-0200-B				
20	20	104	50	3	4	-	-	M9-341708-0200	M9-341708-0200-B				
ISO	V _c [m/min]	d ₁ [mm]											
		3	4	5	6	8	10	12	14	16	18	20	
N	N1-N4	350-450	fz [mm]	fz [mm]	fz [mm]	fz [mm]	fz [mm]	fz [mm]	fz [mm]	fz [mm]	fz [mm]	fz [mm]	fz [mm]
	N7-N9	160-280	0,020	0,030	0,054	0,069	0,085	0,100	0,115	0,135	0,150	0,200	0,220
			0,020	0,030	0,040	0,055	0,070	0,090	0,095	0,105	0,120	0,140	0,150

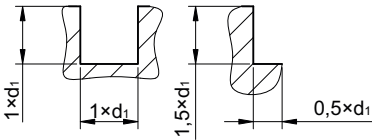

7

For machining aluminium alloys and other non-ferrous materials						AL							
						345	345	R345	R345				
Workpiece material													
Shank													
Tool material						VHM		VHM		VHM		VHM	
Coating						TB		TB		TB		TB	
Corner type													
d ₁	d ₂	l ₁	l ₂	Z	R	INDEX							
14	14	83	32	3	0,5	M9-34B700-0140	M9-34B700-0140-B	M9-34B701-0140	M9-34B701-0140-B				
14	14	83	32	3	1	-	-	M9-34B703-0140	M9-34B703-0140-B				
16	16	92	36	3	0,5	M9-34B700-0160	M9-34B700-0160-B	M9-34B701-0160	M9-34B701-0160-B				
16	16	92	36	3	1	-	-	M9-34B703-0160	M9-34B703-0160-B				
16	16	92	36	3	2	-	-	M9-34B705-0160	M9-34B705-0160-B				
16	16	92	36	3	2,5	-	-	M9-34B706-0160	M9-34B706-0160-B				
16	16	92	36	3	3	-	-	M9-34B707-0160	M9-34B707-0160-B				
18	18	92	45	3	1	M9-34B700-0180	M9-34B700-0180-B	M9-34B703-0180	M9-34B703-0180-B				
20	20	104	50	3	1	M9-34B700-0200	M9-34B700-0200-B	M9-34B703-0200	M9-34B703-0200-B				
20	20	104	50	3	2	-	-	M9-34B705-0200	M9-34B705-0200-B				
20	20	104	50	3	3	-	-	M9-34B707-0200	M9-34B707-0200-B				
20	20	104	50	3	4	-	-	M9-34B708-0200	M9-34B708-0200-B				
ISO	V _c [m/min]	d ₁ [mm]											
		3	4	5	6	8	10	12	14	16	18	20	
N	N1-N4	350-450	fz [mm]	fz [mm]	fz [mm]	fz [mm]	fz [mm]	fz [mm]	fz [mm]	fz [mm]	fz [mm]	fz [mm]	fz [mm]
	N7-N9	160-280	0,020	0,030	0,054	0,069	0,085	0,100	0,115	0,135	0,150	0,200	0,220
			0,020	0,030	0,040	0,055	0,070	0,090	0,095	0,105	0,120	0,140	0,150

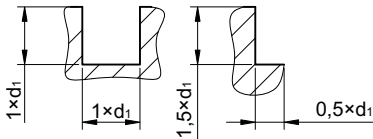

R - for tools with corner radius

Another tool dimensions available on request

For machining aluminium alloys and other non-ferrous materials						AL					
						345	345	R345	R345		
Workpiece material											
Shank											
Tool material						VHM		VHM		VHM	
Coating						TB		TB		TB	
Corner type											
d ₁	d ₂	l ₁	l ₂	Z	R	INDEX					
3	3	39	12	3	0,3	M9-34B700-0030	-	M9-34B70D-0030	-		
4	4	51	12	3	0,3	M9-34B700-0040	-	M9-34B70D-0040	-		
5	5	51	14	3	0,3	M9-34B700-0050	-	M9-34B70D-0050	-		
6	6	57	16	3	0,5	M9-34B700-0060	M9-34B700-0060-B	M9-34B701-0060	M9-34B701-0060-B		
6	6	57	16	3	1	-	-	M9-34B703-0060	M9-34B703-0060-B		
8	8	63	20	3	0,5	M9-34B700-0080	M9-34B700-0080-B	M9-34B701-0080	M9-34B701-0080-B		
8	8	63	20	3	1	-	-	M9-34B703-0080	M9-34B703-0080-B		
8	8	63	20	3	2	-	-	M9-34B705-0080	M9-34B705-0080-B		
10	10	72	22	3	0,5	M9-34B700-0100	M9-34B700-0100-B	M9-34B701-0100	M9-34B701-0100-B		
10	10	72	22	3	1	-	-	M9-34B703-0100	M9-34B703-0100-B		
10	10	72	22	3	1,5	-	-	M9-34B704-0100	M9-34B704-0100-B		
10	10	72	22	3	2	-	-	M9-34B705-0100	M9-34B705-0100-B		
10	10	72	22	3	2,5	-	-	M9-34B706-0100	M9-34B706-0100-B		
12	12	83	32	3	0,5	M9-34B700-0120	M9-34B700-0120-B	M9-34B701-0120	M9-34B701-0120-B		
12	12	83	32	3	1	-	-	M9-34B703-0120	M9-34B703-0120-B		
12	12	83	32	3	1,5	-	-	M9-34B704-0120	M9-34B704-0120-B		
12	12	83	32	3	2	-	-	M9-34B705-0120	M9-34B705-0120-B		
12	12	83	32	3	2,5	-	-	M9-34B706-0120	M9-34B706-0120-B		
12	12	83	32	3	3	-	-	M9-34B707-0120	M9-34B707-0120-B		

ISO	V _c [m/min]	d ₁ [mm]											
		3	4	5	6	8	10	12	14	16	18	20	
N	N1-N4	350-450	0,020	0,030	0,054	0,069	0,085	0,100	0,115	0,135	0,150	0,200	0,220
	N7-N9	160-280	0,020	0,030	0,040	0,055	0,070	0,090	0,095	0,105	0,120	0,140	0,150

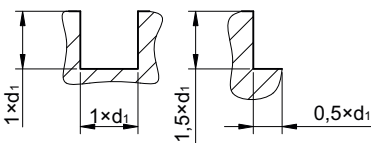

For machining aluminium alloys and other non-ferrous materials							AL						
							345NL						
Workpiece material													
Shank													
Tool material							VHM						
Coating							TB						
Corner type													
d_1	d_2 h6	d_3	l_1	l_2	l_3	Z	INDEX						
3	6	2,7	57	7	17	3	M9-34B7A0-0030						
4	6	3,7	63	8	22	3	M9-34B7A0-0040						
5	6	4,7	67	10	27	3	M9-34B7A0-0050						
6	6	5,5	74	10	32	3	M9-34B7A0-0060						
8	8	7,5	90	12	46	3	M9-34B7A0-0080						
10	10	9,2	102	14	55	3	M9-34B7A0-0100						
12	12	11	117	16	64	3	M9-34B7A0-0120						
16	16	15	141	22	87	3	M9-34B7A0-0160						

ISO	Vc [m/min]	d, [mm]											
		3	4	5	6	8	10	12	14	16	18	20	
		fz [mm]	fz [mm]	fz [mm]	fz [mm]	fz [mm]	fz [mm]	fz [mm]	fz [mm]	fz [mm]	fz [mm]	fz [mm]	fz [mm]
N	N1-N4	150-250	0,020	0,030	0,055	0,070	0,085	0,100	0,115	0,135	0,150	0,200	0,220
	N7-N9	100-200	0,020	0,030	0,040	0,550	0,070	0,090	0,100	0,105	0,120	0,140	0,150

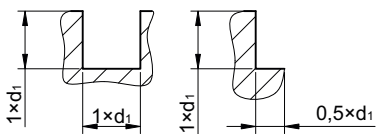

For machining aluminium alloys and other non-ferrous materials

AL

B345NL

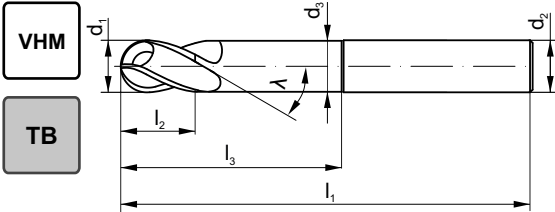
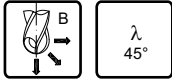
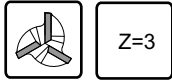

Workpiece material



Shank



Tool material

VHM

Coating

TB

Corner type



d_1	d_2 h6	d_3	l_1	l_2	l_3	Z	R	INDEX
3	6	2,7	57	7	17	3	1,5	M9-34B7AX-0030
4	6	3,7	63	8	22	3	2	M9-34B7AX-0040
5	6	4,7	67	10	27	3	2,5	M9-34B7AX-0050
6	6	5,5	74	10	32	3	3	M9-34B7AX-0060
8	8	7,5	90	12	46	3	4	M9-34B7AX-0080
10	10	9,2	102	14	55	3	5	M9-34B7AX-0100
12	12	11	117	16	64	3	6	M9-34B7AX-0120
16	16	15	141	22	87	3	8	M9-34B7AX-0160

ISO	V_c [m/min]	d_1 [mm]									
		3	4	5	6	8	10	12	14	16	
N	N1-N4	150-250	0,020	0,030	0,055	0,070	0,085	0,100	0,115	0,135	0,150
	N7-N9	100-200	0,020	0,030	0,040	0,550	0,070	0,090	0,100	0,105	0,120

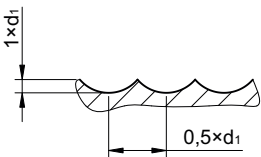

7

For machining aluminium alloys and other non-ferrous materials					AL								
					445	445							
Workpiece material													
Shank													
Tool material					VHM								
Coating					-								
Corner type													
d ₁	d ₂	l ₁	l ₂	Z	INDEX								
3	3	39	12	4	M9-441700-0030	-							
4	4	51	12	4	M9-441700-0040	-							
5	5	51	15	4	M9-441700-0050	-							
6	6	57	18	4	M9-441700-0060	M9-441700-0060-B							
8	8	63	24	4	M9-441700-0080	M9-441700-0080-B							
10	10	72	30	4	M9-441700-0100	M9-441700-0100-B							
12	12	83	36	4	M9-441700-0120	M9-441700-0120-B							
14	14	83	42	4	M9-441700-0140	M9-441700-0140-B							
16	16	92	48	4	M9-441700-0160	M9-441700-0160-B							
18	18	92	54	4	M9-441700-0180	M9-441700-0180-B							
20	20	104	60	4	M9-441700-0200	M9-441700-0200-B							
ISO	V _c [m/min]	d ₁ [mm]											
		3	4	5	6	8	10	12	14	16	18	20	
N	N1-N4 N7-N9	270-400 130-250	fz [mm] 0,025	fz [mm] 0,035	fz [mm] 0,045	fz [mm] 0,055	fz [mm] 0,060	fz [mm] 0,065	fz [mm] 0,070	fz [mm] 0,075	fz [mm] 0,080	fz [mm] 0,090	fz [mm] 0,110

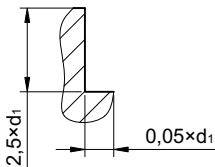

For machining aluminium alloys and other non-ferrous materials						ALZGR						
						R338						
Z=3 λ 38° VHM TB 												
Workpiece material												
Shank												
Tool material						VHM						
Coating						TB						
Corner type												
d_1	d_2 h6	l_1	l_2	Z	R	INDEX						
6	6	57	16	3	0,5	M9-33B701-0060						
8	8	63	20	3	0,5	M9-33B701-0080						
10	10	72	22	3	1	M9-33B703-0100						
12	12	83	26	3	1	M9-33B703-0120						
16	16	92	32	3	2	M9-33B705-0160						
ISO	V_c [m/min]	d_1 [mm]										
		6	8	10	12	16						
		f_z [mm]	f_z [mm]	f_z [mm]	f_z [mm]	f_z [mm]						
N	N1-N4	380-600	0,06	0,09	0,12	0,14	0,2					
	N7-N9	230-400	0,06	0,09	0,12	0,14	0,2					

7

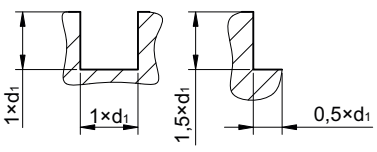

Multipurpose end mill for grooving, profiling, spot drilling, chamfering and engraving

MultiCUT

VHM

AT

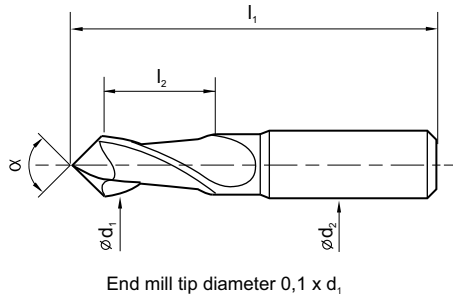

Workpiece material



Coating

AT

Tool material

VHM

Point angle

90°

d ₁	d ₂	l ₁	l _{2 min}	INDEX
1,0	3,00	39	2,0	M9-80V001-0100
1,5	3,00	39	3,0	M9-80V001-0150
2,0	3,00	39	4,0	M9-80V001-0200
2,5	3,00	39	5,0	M9-80V001-0250
3,0	4,00	50	6,0	M9-80V001-0300
4,0	5,00	50	8,0	M9-80V001-0400
5,0	6,00	50	10,0	M9-80V001-0500
6,0	8,00	60	12,0	M9-80V001-0600
8,0	10,00	70	16,0	M9-80V001-0800
10,0	12,00	70	18,0	M9-80V001-1000
12,0	12,00	70	20,0	M9-80V001-1200

Spot drilling

	Vc (m/min)	Feed [mm/tooth]										
		Ø0,3	Ø0,5	Ø1	Ø2	Ø3	Ø5	Ø8	Ø12	Ø16	Ø20	
P	Rm<500	60-75	0,003	0,005	0,012	0,025	0,050	0,100	0,150	0,200	0,250	0,300
	Rm<800	40-60	0,003	0,005	0,012	0,025	0,050	0,100	0,150	0,200	0,250	0,300
	Rm<1000	35-40	0,003	0,005	0,010	0,023	0,045	0,070	0,120	0,180	0,220	0,280
	Rm<1400	30-35	0,002	0,004	0,009	0,023	0,045	0,070	0,120	0,170	0,220	0,260
M	25-30	0,002	0,004	0,010	0,020	0,040	0,060	0,110	0,160	0,220	0,250	
K	30-35	0,002	0,004	0,009	0,023	0,045	0,070	0,120	0,170	0,220	0,260	
N	50-150	0,003	0,005	0,020	0,040	0,070	0,120	0,200	0,250	0,320	0,400	
S	15-20	0,002	0,004	0,010	0,020	0,040	0,060	0,110	0,160	0,200	0,250	

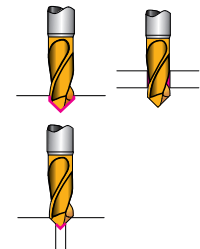

Grooving

	Vc (m/min)	Feed [mm/tooth]										
		Ø0,3	Ø0,5	Ø1	Ø2	Ø3	Ø5	Ø8	Ø12	Ø16	Ø20	
P	Rm<500	60-75	0,002	0,003	0,005	0,008	0,010	0,018	0,030	0,040	0,050	0,065
	Rm<800	40-60	0,001	0,002	0,004	0,008	0,010	0,015	0,030	0,040	0,050	0,065
	Rm<1000	35-40	0,001	0,002	0,004	0,008	0,010	0,015	0,030	0,040	0,050	0,065
	Rm<1400	30-35	0,001	0,002	0,004	0,006	0,008	0,012	0,025	0,032	0,040	0,055
M	25-30	0,001	0,002	0,004	0,006	0,008	0,012	0,025	0,032	0,040	0,055	
K	30-35	0,001	0,002	0,004	0,006	0,008	0,012	0,025	0,032	0,040	0,055	
N	50-150	0,001	0,003	0,006	0,012	0,016	0,020	0,034	0,040	0,060	0,080	
S	15-20	0,001	0,001	0,003	0,005	0,006	0,010	0,020	0,026	0,036	0,050	

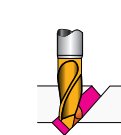

Engraving/Chamfering/Profiling

	Vc (m/min)	Feed [mm/tooth]										
		Ø0,3	Ø0,5	Ø1	Ø2	Ø3	Ø5	Ø8	Ø12	Ø16	Ø20	
P	Rm<500	60-75	0,002	0,004	0,008	0,012	0,015	0,020	0,038	0,060	0,080	0,100
	Rm<800	40-60	0,002	0,004	0,008	0,012	0,015	0,020	0,038	0,060	0,080	0,100
	Rm<1000	35-40	0,002	0,003	0,008	0,012	0,014	0,020	0,038	0,060	0,080	0,090
	Rm<1400	30-35	0,001	0,003	0,007	0,012	0,014	0,020	0,038	0,055	0,075	0,080
M	25-30	0,011	0,002	0,005	0,010	0,012	0,018	0,035	0,050	0,065	0,080	
K	30-35	0,001	0,003	0,007	0,012	0,014	0,020	0,038	0,055	0,075	0,080	
N	50-150	0,002	0,005	0,009	0,018	0,014	0,022	0,042	0,065	0,072	0,095	
S	15-20	0,001	0,002	0,005	0,010	0,012	0,018	0,035	0,050	0,065	0,080	

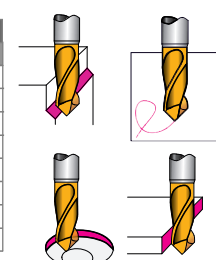

- Available from stock
- On request

7

For NPT, NPTF, BSPT (1:16) threads						
Workpiece material						
Shank						
Tool material						VHM
Coating						TS
Corner type						
d_1	d_2 h6	l_1	l_2	Z	Threads	INDEX
5,2	6	58	12	4	1/16" - 1/8"	M9-43GD00-0052
8,5	10	73	24	4	1/8" - 1"	M9-43GD00-0085
10	12	84	33	4	1/4" - 3"	M9-43GD00-0100

GAUGES



A	MSBa	Smooth plug gauges	217
M	MSBg	Thread gauges plug	218
	MSRh	GO thread ring gauge	
	MSRk	NO GO thread ring gauge	
MF	MSBg	Thread gauges plug	219 - 220
	MSRh	GO thread ring gauge	
	MSRk	NO GO thread ring gauge	
UNC	MSBg	Thread gauges plug	221
	MSRh	GO thread ring gauge	
	MSRk	NO GO thread ring gauge	
UNF	MSBg	Thread gauges plug	222
	MSRh	GO thread ring gauge	
	MSRk	NO GO thread ring gauge	
G	MSBg	Thread gauges plug	223
	MSRh	GO thread ring gauge	
	MSRk	NO GO thread ring gauge	
R Rc/Rp	MSXa	Thread gauges plug	224
	MSXc	Thread gauges ring	
Pg	MSBg	Thread gauges plug	225
	MSRh	GO thread ring gauge	
	MSRc	NO GO ring gauge	
BSW	MSBg	Thread gauges plug	226
	MSRh	GO thread ring gauge	
	MSRk	NO GO thread ring gauge	
NPT	MSXa	Thread gauges plug	227
	MSXc	Thread gauges ring	
Tr	MSBg	Thread gauges plug	228
	MSRh	GO thread ring gauge	
	MSRk	NO GO thread ring gauge	

Gauge dimensions
PN-EN ISO 1938-1:2016-03



Symbol		MSBa	MSBa				
Typ		GO / NOGO	GO / NOGO				
Ø nom.	Tol	H7	H8				
	INDEX	S3-100111	S3-100112				
1	0010	●	○				
1,2	0012	●	○				
1,5	0015	●	○				
1,8	0018	●	○				
2	0020	●	○				
2,2	0022	●	○				
2,5	0025	●	○				
2,8	0028	●	○				
3	0030	●	○				
3,5	0035	○	○				
4	0040	●	○				
4,5	0045	○	○				
5	0050	●	○				
6	0060	●	○				
7	0070	○	○				
8	0080	●	○				
9	0090	○	○				
10	0100	●	○				
12	0120	●	○				
14	0140	●	○				
16	0160	●	○				
18	0180	●	○				
20	0200	●	○				
22	0220	●	○				
24	0240	●	○				
25	0250	●	○				
26	0260	●	○				
27	0270	○	○				
28	0280	●	○				
30	0300	●	○				
32	0320	●	○				
33	0330	●	○				
34	0340	●	○				
35	0350	●	○				
36	0360	●	○				
37	0370	●	○				
38	0380	●	○				
40	0400	●	○				
42	0420	●	○				
44	0440	○	○				
45	0450	●	○				
46	0460	○	○				
47	0470	●	○				
48	0480	○	○				
50	0500	●	○				
52	0520	○	○				



GO gauges above M42 are called MSCb and NO GO MSCc and they are produced with separate handle



ISO Metric coarse thread DIN-13



⌚ LH

Ⓞ 6G

Symbol			MSBg	MSBg LH	MSBg	MSRh	MSRk
Typ			GO / NOGO	GO / NOGO	GO / NOGO	GO	NOGO
M	P	Tol	6H	6H	6G	6g	6g
		INDEX	S3-302161	S3-301161	S3-302162	Y3-412162	Y3-422162
M 1	0,25	0010	●	○	○	●	●
M 1,2	0,25	0012	●	○	○	●	●
M 1,4	0,3	0014	●	○	○	●	●
M 1,6	0,35	0016	●	○	○	●	●
M 1,7	0,35	0017	●	○	○	●	●
M 1,8	0,35	0018	●	○	○	●	●
M 2	0,4	0020	●	○	○	●	●
M 2,2	0,45	0022	●	○	○	●	●
M 2,5	0,45	0025	●	○	○	●	●
M 2,6	0,45	0026	●	○	○	●	●
M 3	0,5	0030	●	○	○	●	●
M 3,5	0,6	0035	●	○	○	●	●
M 4	0,7	0040	●	○	○	●	●
M 4,5	0,75	0045	●	○	○	●	●
M 5	0,8	0050	●	○	○	●	●
M 6	1	0060	●	○	○	●	●
M 7	1	0070	●	○	○	●	●
M 8	1,25	0080	●	○	○	●	●
M 9	1,25	0090	●	○	○	●	●
M 10	1,5	0100	●	○	○	●	●
M 12	1,75	0120	●	○	○	●	●
M 14	2	0140	●	○	○	●	●
M 16	2	0160	●	○	○	●	●
M 18	2,5	0180	●	○	○	●	●
M 20	2,5	0200	●	○	○	●	●
M 22	2,5	0220	●	○	○	●	●
M 24	3	0240	●	○	○	●	●
M 27	3	0270	●	○	○	●	●
M 30	3,5	0300	●	○	○	●	●
M 33	3,5	0330	●	○	○	●	●
M 36	4	0360	●	○	○	●	●
M 39	4	0390	●	○	○	●	●
M 42	4,5	0420	○	○	○	●	●
M 45	4,5	0450	○	○	○	●	●
M 48	5	0480	○	○	○	●	●
M 52	5	0520	○	○	○	●	●



Set of gauges on p. 263



GO gauges above M42 are called MSCh and NO GO MSCh and they are produced with separate handle

ISO Metric coarse thread DIN-13



Symbol				MSBg	MSBg LH	MSBg	MSRh	MSRk
Typ				GO / NOGO	GO / NOGO	GO / NOGO	GO	NOGO
MF	P	Tol	INDEX	6H	6H	6G	6g	6g
				S3-302161	S3-301161	S3-302162	Y3-412162	Y3-422162
M 3 x 0,35	0,35	0031	○	○	○	○	○	○
M 3,5 x 0,35	0,35	0036	○	○	○	○	○	○
M 4 x 0,35	0,35	0043	○	○	○	○	○	○
M 4x0,5	0,5	0041	○	○	○	○	○	○
M 4,5 x 0,5	0,5	0046	○	○	○	○	○	○
M 5 x 0,5	0,5	0051	○	○	○	○	○	○
M 6 x 0,5	0,5	0061	○	○	○	○	○	○
M 6 x 0,75	0,75	0062	○	○	○	○	○	○
M 8 x 0,5	0,5	0081	○	○	○	○	○	○
M 8 x 0,75	0,75	0082	○	○	○	○	○	○
M 8 x 1	1	0083	●	●	○	●	●	●
M 9 x 1	1	0093	○	○	○	○	○	○
M 10 x 0,75	0,75	0102	○	○	○	○	○	○
M 10 x 1	1	0103	●	●	○	●	●	●
M 10 x 1,25	1,25	0104	●	●	○	●	●	●
M 11 x 1	1	0113	○	○	○	○	○	○
M 12 x 1	1	0123	●	●	○	●	●	●
M 12 x 1,25	1,25	0124	●	●	○	●	●	●
M 12 x 1,5	1,5	0125	●	●	○	●	●	●
M 13 x 1	1	0133	○	○	○	○	○	○
M 14 x 1	1	0143	○	○	○	○	○	○
M 14 x 1,25	1,25	0144	○	○	○	○	○	○
M 14 x 1,5	1,5	0145	●	●	○	●	●	●
M 15 x 1	1	0153	○	○	○	○	○	○
M 15 x 1,5	1,5	0155	○	○	○	○	○	○
M 16 x 1	1	0163	●	●	○	●	●	●
M 16 x 1,5	1,5	0165	●	●	○	●	●	●
M 18 x 1	1	0183	○	○	○	○	○	○
M 18 x 1,5	1,5	0185	●	●	○	●	●	●
M 18 x 2	2	0186	○	○	○	○	○	○
M 20 x 1	1	0203	●	●	○	●	●	●
M 20 x 1,5	1,5	0205	●	●	○	●	●	●
M 20 x 2	2	0206	○	○	○	○	○	○
M 22 x 1	1	0223	○	○	○	○	○	○
M 22 x 1,5	1,5	0225	●	●	○	●	●	●
M 22 x 2	2	0226	●	●	○	●	●	●
M 24 x 1	1	0243	○	○	○	○	○	○
M 24 x 1,5	1,5	0245	●	●	○	●	●	●
M 24 x 2	2	0246	●	○	○	○	○	○
M 25 x 1,5	1,5	0255	●	○	○	○	○	○
M 26 x 1,5	1,5	0265	●	○	○	○	○	○
M 27 x 1,5	1,5	0275	●	○	○	○	○	○



ISO Metric fine thread DIN-13



Gauge dimensions ISO 1502

Symbol				MSBg	MSBg LH	MSBg	MSRh	MSRk
Typ				GO / NOGO	GO / NOGO	GO / NOGO	GO	NOGO
MF	P	Tol	INDEX	6H	6H	6G	6g	6g
				S3-302161	S3-301161	S3-302162	Y3-412162	Y3-422162
M 27 x 2	2	0276	●	○	○	○	○	○
M 28 x 1,5	1,5	0285	●	○	○	○	○	○
M 28 x 2	2	0286	○	○	○	○	○	○
M 30 x 1	1	0303	○	○	○	○	○	○
M 30 x 1,5	1,5	0305	●	○	○	○	○	○
M 30 x 2	2	0306	●	○	○	○	○	○
M 32 x 1,5	1,5	0325	●	○	○	○	○	○
M 33 x 1,5	1,5	0335	●	○	○	○	○	○
M 33 x 2	2	0336	●	○	○	○	○	○
M 33 x 3	3	0337	○	○	○	○	○	○
M 34 x 1,5	1,5	0345	○	○	○	○	○	○
M 35 x 1,5	1,5	0355	●	○	○	○	○	○
M 36 x 1,5	1,5	0365	●	○	○	○	○	○
M 36 x 2	2	0366	●	○	○	○	○	○
M 36 x 3	3	0367	○	○	○	○	○	○
M 38 x 1,5	1,5	0385	●	○	○	○	○	○
M 39 x 2	2	0396	●	○	○	○	○	○
M 39 x 3	3	0397	○	○	○	○	○	○
M 40 x 1,5	1,5	0405	●	○	○	○	○	○
M 40 x 2	2	0406	○	○	○	○	○	○
M 40 x 3	3	0407	○	○	○	○	○	○
M 42 x 1,5	1,5	0425	○	○	○	○	○	○
M 42 x 2	2	0426	○	○	○	○	○	○
M 42 x 3	3	0427	○	○	○	○	○	○
M 45 x 1,5	1,5	0455	○	○	○	○	○	○
M 45 x 2	2	0456	○	○	○	○	○	○
M 45 x 3	3	0457	○	○	○	○	○	○
M 48 x 1,5	1,5	0485	○	○	○	○	○	○
M 48 x 2	2	0486	○	○	○	○	○	○
M 48 x 3	3	0487	○	○	○	○	○	○
M 50 x 1,5	1,5	0505	○	○	○	○	○	○
M 50 x 2	2	0506	○	○	○	○	○	○
M 50 x 3	3	0507	○	○	○	○	○	○
M 52 x 1,5	1,5	0525	○	○	○	○	○	○
M 52 x 2	2	0526	○	○	○	○	○	○
M 52 x 3	3	0527	○	○	○	○	○	○

8



Set of gauges p. 263



GO gauges above M42 are called MSCh and NO GO MSCh and they are produced with separate handle

American unified coarse thread UNC, ANSI B-1.1							
Gauge dimensions ANSI/ASME B1.2							
Symbol				MSBg	MSBg	MSRh	MSRk
Typ				GO / NOGO	GO / NOGO	GO	NOGO
UNC	Ø d _i	1"/P	Tol	2B	3B	2A	2A
			INDEX	S3-302186	S3-302187	Y3-412182	Y3-422182
No 5 - 40	3,175	40	4105	●	○	○	○
No 6 - 32	3,505	32	4106	●	○	○	○
No 8 - 32	4,166	32	4108	●	○	○	○
No 10 - 24	4,826	24	4110	●	○	○	○
No 12 - 24	5,486	24	4112	●	○	○	○
1/4 - 20	6,350	20	4127	●	○	○	○
5/16 - 18	7,938	18	4128	●	○	○	○
3/8 - 16	9,525	16	4129	●	○	○	○
7/16 - 14	11,112	14	4130	●	○	○	○
1/2 - 13	12,700	13	4131	●	○	○	○
9/16 - 12	14,288	12	4132	●	○	○	○
5/8 - 11	15,875	11	4133	●	○	○	○
3/4 - 10	19,050	10	4135	●	○	○	○
7/8 - 9	22,225	9	4137	●	○	○	○
1 - 8	25,400	8	4139	●	○	○	○
1.1/8 - 7	28,575	7	4141	○	○	○	○
1.1/4 - 7	31,750	7	4143	○	○	○	○
1.3/8 - 6	34,925	6	4145	○	○	○	○
1.1/2 - 6	38,100	6	4147	○	○	○	○
1.3/4 - 5	44,450	5	4151	○	○	○	○
2 - 4.1/2	50,800	4.1/2	4155	○	○	○	○



GO gauges above 1 3/4" - UNC are called MSCh and NO GO MSCh and they are produced with separate handle



American unified fine thread UNF, ANSI B-1.1





Gauge dimensions ANSI/ASME B1.2

Symbol				MSBg	MSBg	MSRh	MSRk
Typ				GO / NOGO	GO / NOGO	GO	NOGO
UNF	Ø d _i	1"/P	Tol	2B	3B	2A	2A
			INDEX	S3-302186	S3-302187	Y3-412182	Y3-422182
No 5 - 44	3,175	44	4205	○	○	○	○
No 6 - 40	3,505	40	4206	○	○	○	○
No 8 - 36	4,166	36	4208	○	○	○	○
No 10 - 32	4,826	32	4210	○	○	○	○
No 12 - 28	5,486	28	4212	○	○	○	○
1/4 - 28	6,350	28	4227	●	○	○	○
5/16 - 24	7,938	24	4228	●	○	○	○
3/8 - 24	9,525	24	4229	●	○	○	○
7/16 - 20	11,112	20	4230	●	○	○	○
1/2 - 20	12,700	20	4231	●	○	○	○
9/16 - 18	14,288	18	4232	●	○	○	○
5/8 - 18	15,875	18	4233	●	○	○	○
3/4 - 16	19,050	16	4235	●	○	○	○
7/8 - 14	22,225	14	4237	●	○	○	○
1 - 12	25,400	12	4239	●	○	○	○
1.1/8 - 12	28,575	12	4241	○	○	○	○
1.1/4 - 12	31,750	12	4243	○	○	○	○
1.3/8 - 12	34,925	12	4245	○	○	○	○
1.1/2 - 12	38,100	12	4247	○	○	○	○

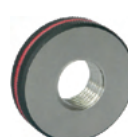

GO gauges above 1 3/4" - UNC are called MSCh and NO GO MSCh and they are produced with separate handle

Whitworth pipe thread G, DIN-ISO 228						
				  		
Symbol				MSBg	MSRh	MSRk
Typ				GO / NOGO	GO	NOGO
G	Ø d _i	1"/P	Tol	A		
			INDEX	S3-302180	Y3-412180	Y3-422180
G-1/8"	9,73	28	3123	●	○	○
G-1/4"	13,16	19	3127	●	○	○
G-3/8"	16,66	19	3129	●	●	●
G-1/2"	20,96	14	3131	●	●	●
G-5/8"	22,91	14	3133	○	○	○
G-3/4"	26,44	14	3135	●	●	●
G-7/8"	30,20	14	3137	○	○	○
G-1"	33,25	11	3139	●	●	●
G-1.1/8"	37,90	11	3141	●	○	○
G-1.1/4"	41,91	11	3143	●	○	○



Pipe thread without dry seal material				PN-EN 10226-3 (ISO7-2:2000)						
<p>55° P 1:16 R, Rc</p> <p>55° P Rp</p> <p>PN-EN 10226-1, PN-EN 10226-2 (ISO7-1:2000)</p> <p>Gauge system acc. PN-EN 10226-3</p> <p>Gauge dimensions PN-EN 10226-3</p>										
Symbol				MSXa	MSXa	MSXc	MSXc	MSXc	MSXa	
Typ				Nr 1	Nr 2	Nr 3	Nr 4	Nr 5		
Rc/Rp	Ø d ₁	1"/P	Tol	Rc/Rp	Rc/Rp	R	R	R		
			INDEX	S3-332101	S3-332102	-	-	S3-332105		
1/16"	7,72	28	3321	o	o			o		
1/8"	9,73	28	3323	o	o			o		
1/4"	13,16	19	3327	o	o			o		
3/8"	16,66	19	3329	o	o			o		
1/2"	20,96	14	3331	o	o			o		
3/4"	26,44	14	3335	o	o			o		
1"	32,25	11	3339	o	o			o		
1.1/4"	41,91	11	3343	o	o			o		
1.1/2"	47,80	11	3347	o	o			o		
2"	59,61	11	3355	o	o			o		
2.1/2"	75,18	11	3359	o	o			o		
3"	87,88	11	3363	o	o			o		
4"	113,03	11	3371	o	o			o		
R	Ø d ₁	1"/P	INDEX	-	-	Y3-432103	Y3-432104	-		
1/16"	7,72	28	3421			o	o			
1/8"	9,73	28	3423			o	o			
1/4"	13,16	19	3427			o	o			
3/8"	16,66	19	3429			o	o			
1/2"	20,96	14	3431			o	o			
3/4"	26,44	14	3435			o	o			
1"	32,25	11	3439			o	o			
1.1/4"	41,91	11	3443			o	o			
1.1/2"	47,80	11	3447			o	o			
2"	59,61	11	3455			o	o			
2.1/2"	75,18	11	3459			o	o			
3"	87,88	11	3463			o	o			
4"	113,03	11	3471			o	o			



Technical information concerning construction and use of gauges R an RC/RP in the technical part of the catalogue on p. 306

Steel conduit thread Pg, DIN-40430							
							
Symbol					MSBg	MSRh	MSRc
Typ					GO / NOGO	GO	NOGO
Pg	Ø d _i	1"/P	Tol				
			INDEX	S3-832100	Y3-412100	Y3-450100	
Pg 7	12,5	20	8807	o	o	o	
Pg 9	15,2	18	8809	o	o	o	
Pg 11	18,6	18	8811	o	o	o	
Pg 13,5	20,4	18	8813	o	o	o	
Pg 16	22,5	18	8816	o	o	o	
Pg 21	28,3	16	8821	o	o	o	
Pg 29	37	16	8829	o	o	o	
Pg 36	47	16	8836	o	o	o	



Pg thread is replaced by metric fine MF according to DIN 60423 available on request



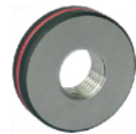

Whitworth thread BSW, BS-84:1956

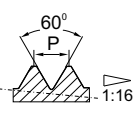

Gauge dimensions BS 919-2

Symbol				MSBg	MSRh	MSRk
Typ				GO / NOGO	GO	NOGO
BSW	Ø d _t	1"/P	Tol	medium	medium	medium
			INDEX	S3-302100	Y3-412100	Y3-422100
1/8 - 40	3,175	40	7123	o	o	o
3/16 - 24	4,762	24	7125	o	o	o
1/4 - 20	6,350	20	7127	o	o	o
5/16 - 18	7,938	18	7128	o	o	o
3/8 - 16	9,525	16	7129	o	o	o
7/16 - 14	11,112	14	7130	o	o	o
1/2 - 12	12,700	12	7131	o	o	o
9/16 - 12	14,288	12	7132	o	o	o
5/8 - 11	15,875	11	7133	o	o	o
3/4 - 10	19,050	10	7135	o	o	o
7/8 - 9	22,225	9	7137	o	o	o
1 - 8	25,400	8	7139	o	o	o
1.1/8 - 7	28,575	7	7141	o	o	o
1.1/4 - 7	31,750	7	7143	o	o	o
1.3/8 - 6	34,925	6	7145	o	o	o
1.1/2 - 6	38,100	6	7147	o	o	o
1.3/4 - 5	44,450	5	7151	o	o	o
2 - 4.1/2	50,800	4.1/2	7155	o	o	o

American tapered pipe thread NPT 1:16, ANSI B-1.20.1					
					
Gauge dimensions ANSI/ASME B1.20.1					
Symbol				MSXa	MSXc
Typ					
NPT Ø d ₁	1"/P	Tol		S3-332100	Y3-432100
		INDEX			
1/16"	27	4621	○	○	
1/8"	27	4623	○	○	
1/4"	18	4627	○	○	
3/8"	18	4629	●	○	
1/2"	14	4631	●	○	
3/4"	14	4635	●	○	
1"	11.1/2	4639	●	○	
1.1/4"	11.1/2	4643	○	○	
1.1/2"	11.1/2	4647	○	○	
2"	11.1/2	4655	○	○	



Technical information concerning use of gauges NPT in the technical part of the catalogue on p. 303



Trapezoidal thread Tr, DIN-103

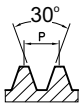

Gauge dimensions DIN 103-9

Symbol			MSBg	MSRh	MSRk
Typ			GO / NOGO	GO	NOGO
Tr Ø d _i [mm]	P [mm]	Tol	7H	7e	7e
		INDEX	S3-302171	Y3-412174	Y3-422174
Tr 10 x 2	2	8009	o	o	o
Tr 12 x 3	3	8015	o	o	o
Tr 14 x 3	3	8019	o	o	o
Tr 16 x 4	4	8024	o	o	o
Tr 18 x 4	4	8032	o	o	o
Tr 20 x 4	4	8034	o	o	o
Tr 22 x 5	5	8037	o	o	o
Tr 24 x 5	5	8042	o	o	o
Tr 26 x 5	5	8047	o	o	o
Tr 28 x 5	5	8052	o	o	o
Tr 30 x 6	6	8057	o	o	o
Tr 32 x 6	6	8062	o	o	o
Tr 36 x 6	6	8072	o	o	o

TOOL HOLDERS



MS	Tap holders „SOFT SYNCHRO“	MASTERSYNC	232 - 233
OGK	Quick change tap holders with axial compensation		234 - 237
OGN	Reversing tapping attachments		238
FZS	Quick-change adapters with safety clutch for taps		239
FZ	Quick-change adapters without safety clutch for taps		240
FZA	Adapters for ER collets clamping		241
FR	Adapters reduction		241
ER	Collets for shank tools clamping		242
ERC	Collets with square drive for taps		243
ERG	Rubber sealed collets		244
ERCG	Rubber sealed collets with square drive for taps		244
R	Sealing gaskets		245
TR	Reduction collets with high clamping force		246
TRH	Reduction collets for TRH		247
RF	Rubber flex collets for OGN holders		248
C	Pull studs		249 - 250

MASTERSYNC

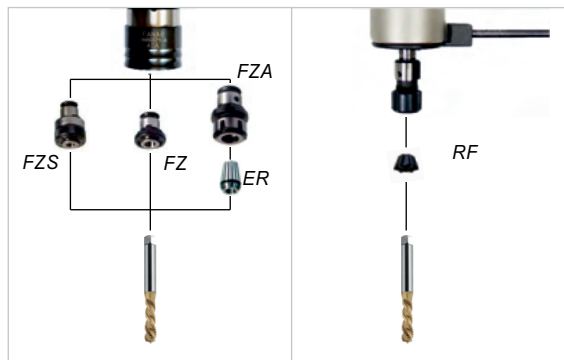
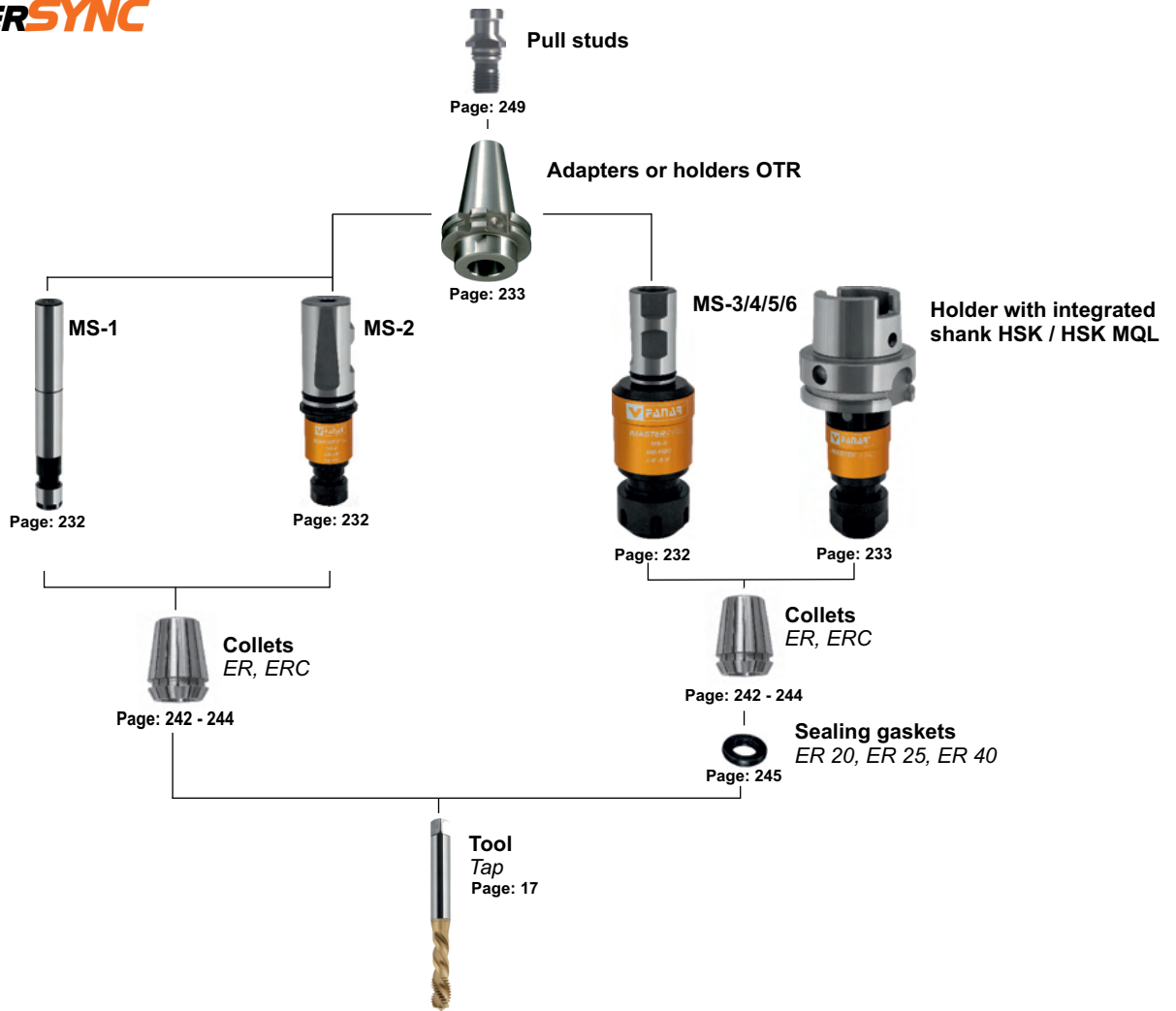

Page	234 - 237	238
Description	For tapping with axial compression and extension compensation	For tapping with axial compression and extension compensation and reversing motion intended for machines with the right spindle rotation

Shank	Norm	Symbol	OGK	OGN
MORSE'A	DIN-228 A/B	MK	MK2, MK3, MK4, MK5	MK1, MK2, MK3, MK4 (JT6, M20)
DIN	DIN-2080	DIN	DIN30, DIN40, DIN50	
TR	DIN-6327	TR	TR20, TR28, TR36, TR48	
ISO	DIN 69871 A	ISO	ISO30, ISO40, ISO50	
MAS-BT	JIS B 6339	BT	BT30, BT40, BT50	
HSK	DIN 69893 A	HSK	HSK50, HSK63, HSK80, HSK100	
VDI	DIN 69880	VDI	VDI20, VDI25, VDI30, VDI40, VDI50	
WELDON	DIN 1835 B	W	W20, W25, W32, W40	
POLYGONAL	ISO 26623-1	C	C40, C50, C63, C80	

• Axial compensation: +/- 0,5

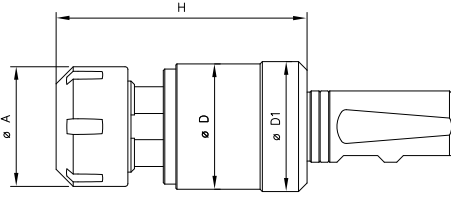

Accessories

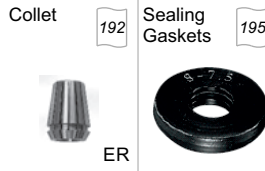

MASTER SYNC

MS-1 MS-2 MS-3 MS-4 MS-5 MS-6



									MS-1	MS-2	MS-3	MS-4	MS-5	MS-6	
Capacity									M1+M3	M2+M5	M4,5+M12	M8+M20	M16+M30	M22+M48	
Internal cooling									-	-	IK	IK	IK	IK	
Model	Shank	Collet	M	D	D ₁	A	H	Sealing Gaskets	INDEX						
MS-1-D12	12	ER8	M1+M3	12	12	12	28	-	R-MS-1-D12						
MS-2-W25	25	ER11	M2+M5	23,5	23,5	19	52	-		R-MS-2-W25					
MS-3-W25	25	ER20	M4,5+M12	34,6	36,3	34	69	+			R-MS-3-W25				
MS-4-W25	25	ER25	M8+M20	44	45,6	42	88	+				R-MS-4-W25			
MS-5-W25	25	ER40	M16+M30	62	63,6	63	117	+					R-MS-5-W25		
MS-6-W40	40	ER50	M22+M48	80	87	78	166	+						R-MS-6-W40	

• Axial compensation: +/- 0,5

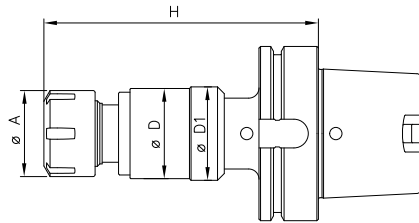

Accessories



MASTER SYNC

MS-3 MS-4 MS-5



									MS-3	MS-4	MS-5	
Capacity									M4+M12	M8+M20	M16+M30	
Internal cooling									IK	IK	IK	
Model	Shank	Collet	M	D	D ₁	A	H	Sealing Gaskets	INDEX			
MS-3-HSK63A	HSK63A	ER20	M4+M12	34,6	36,3	34	108	+	R-MS-3-HSK63A			
MS-3-HSK80A	HSK80A	ER20	M4+M12	34,6	36,3	34	113	+	R-MS-3-HSK80A			
MS-3-HSK100A	HSK100A	ER20	M4+M12	34,6	36,3	34	115	+	R-MS-3-HSK100A			
MS-4-HSK63A	HSK63A	ER25	M8+M20	44	45,6	42	128	+		R-MS-4-HSK63A		
MS-4-HSK80A	HSK80A	ER25	M8+M20	44	45,6	42	115	+		R-MS-4-HSK80A		
MS-4-HSK100A	HSK100A	ER25	M8+M20	44	45,6	42	131	+		R-MS-4-HSK100A		
MS-5-HSK63A	HSK63A	ER40	M16+M30	62	63,6	63	160	+			R-MS-5-HSK63A	
MS-5-HSK80A	HSK80A	ER40	M16+M30	62	63,6	63	161	+			R-MS-5-HSK80A	
MS-5-HSK100A	HSK100A	ER40	M16+M30	62	63,6	63	163	+			R-MS-5-HSK100A	

Features and Advantages

- increase tap life by 100% or more
- improves thread quality
- precise lubrication delivery for improved tool life
- reduce coolant and maintenance costs
- environmentally friendly alternative to recirculating coolant
- standard for one channel system, but multi-channel also available
- axial compensation: +/- 0,5

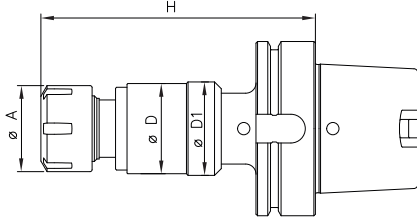

MASTER SYNC

MS-3

MS-4



Capacity

M4+M12

M8+M20

Internal cooling

MQL

MQL

Model	Shank	Collet	M	D	D ₁	A	H	Sealing Gaskets	INDEX
MS-3-HSK63A-MQL	HSK63A	ER20	M4+M12	34,6	36,6	34	108	+	R-MS-3-HSK63A-MQL
MS-3-HSK80A-MQL	HSK80A	ER20	M4+M12	34,6	36,6	34	113	+	R-MS-3-HSK80A-MQL
MS-3-HSK100A-MQL	HSK100A	ER20	M4+M12	34,6	36,6	34	115	+	R-MS-3-HSK100A-MQL
MS-4-HSK63A-MQL	HSK63A	ER25	M8+M20	44	44	42	128	+	R-MS-4-HSK63A-MQL
MS-4-HSK80A-MQL	HSK80A	ER25	M8+M20	44	44	42	131	+	R-MS-4-HSK80A-MQL
MS-4-HSK100A-MQL	HSK100A	ER25	M8+M20	44	44	42	133	+	R-MS-4-HSK100A-MQL

ADAPTERS

ISO/CAT

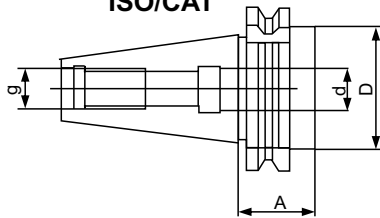

OT

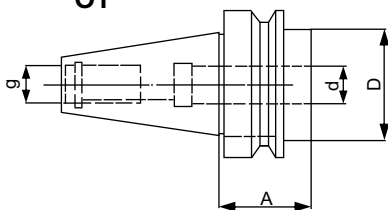

Capacity

Internal cooling

Model	Shank	D	d	A	g		INDEX
ISO40	ISO40	45	25	35	M16	DIN-69871	R-OTR-ISO40/D25
ISO40	ISO40	90	40	120	M16	DIN-69871	R-OTR-ISO40/D40
ISO50	ISO50	72	25	35	M24	DIN-69871	R-OTR-ISO50/D25
ISO50	ISO50	90	40	100	M24	DIN-69871	R-OTR-ISO50/D40
CAT40	CAT40	45	25	35	5/8"-11	CAT	R-OTR-CAT40/D25
CAT50	CAT50	70	25	35	1"-8	CAT	R-OTR-CAT50/D25
CAT50	CAT50	70	40	75	1"-8	CAT	R-OTR-CAT50/D40
BT40	BT40	45	25	35	M16	DIN-B6339	R-OTR-BT40/D25
BT50	BT50	70	25	48	M24	DIN-B6339	R-OTR-BT50/D25
BT50	BT50	90	40	110	M24	DIN-B6339	R-OTR-BT50/D40

									MK		MK-A	
Accessories												
			Adapters ¹⁸⁸ FZS		Adapters ¹⁹¹ FZA		Collet ¹⁹² ER		MORSE DIN-228 B		MORSE DIN-228 A	
Norm												
Internal cooling												
Shank	Adapters	D	A	H	M	↕		INDEX		INDEX		
						(-)	(+)					
MK2	FZ19	19	38	46	M2-M12	9	9	R-OGK-MK2/FZ19	●			
MK3	FZ19	19	38	46	M2-M12	9	9	R-OGK-MK3/FZ19	●			
MK3	FZ31	31	55	69	M6-M20	15	15	R-OGK-MK3/FZ31	●			
MK4	FZ48	48	79	108	M14-M33	24	24	R-OGK-MK4/FZ48	●			
MK5	FZ60	60	98	116	M22-M48	26	26	R-OGK-MK5/FZ60	●			
MK2	FZ19	19	38	46	M2-M12	9	9			R-OGK-MK2/FZ19-A	○	
MK3	FZ19	19	38	46	M2-M12	9	9			R-OGK-MK3/FZ19-A	○	
MK3	FZ31	31	55	69	M6-M20	15	15			R-OGK-MK3/FZ31-A	○	
MK4	FZ48	48	79	108	M14-M33	24	24			R-OGK-MK4/FZ48-A	○	
MK5	FZ60	60	98	116	M22-M48	26	26			R-OGK-MK5/FZ60-A	○	
									DIN		TR	
Accessories												
			Adapters ¹⁸⁸ FZS		Adapters ¹⁹¹ FZA		Collets ¹⁹² ER		DIN-2080		DIN-6327	
Norm												
Internal cooling												
Shank	Adapter	D	A	H	M	↕		INDEX		INDEX		
						(-)	(+)					
DIN30	FZ19	19	38	51	M2-M12	9	9	R-OGK-DIN30/FZ19	○			
DIN30	FZ31	31	55	86	M6-M20	15	15	R-OGK-DIN30/FZ31	○			
DIN40	FZ19	19	38	53	M2-M12	9	9	R-OGK-DIN40/FZ19	○			
DIN40	FZ31	31	55	77	M6-M20	15	15	R-OGK-DIN40/FZ31	○			
DIN40	FZ48	48	79	118	M14-M33	24	24	R-OGK-DIN40/FZ48	○			
DIN50	FZ19	19	38	57	M2-M12	9	9	R-OGK-DIN50/FZ19	○			
DIN50	FZ31	31	55	79	M6-M20	15	15	R-OGK-DIN50/FZ31	○			
DIN50	FZ48	48	79	125	M14-M33	24	24	R-OGK-DIN50/FZ48	○			
DIN50	FZ60	60	98	143	M22-M48	26	26	R-OGK-DIN50/FZ60	○			
TR20	FZ19	19	38	53	M2-M12	9	9			R-OGK-TR20/FZ19	○	
TR28	FZ19	19	38	53	M2-M12	9	9			R-OGK-TR28/FZ19	○	
TR28	FZ31	31	55	76	M6-M20	15	15			R-OGK-TR28/FZ31	○	
TR36	FZ19	19	38	55	M2-M12	9	9			R-OGK-TR36/FZ19	○	
TR36	FZ31	31	55	78	M6-M20	15	15			R-OGK-TR36/FZ31	○	
TR36	FZ48	48	79	111	M14-M33	24	24			R-OGK-TR36/FZ48	○	
TR36	FZ60	60	98	123	M22-M48	26	26			R-OGK-TR36/FZ60	○	
TR48	FZ48	48	79	115	M14-M33	24	24			R-OGK-TR48/FZ48	○	
TR48	FZ60	60	98	127	M22-M48	26	26			R-OGK-TR48/FZ60	○	

							ISO		MAS BT		
Accessories <div style="display: flex; justify-content: space-around; align-items: flex-start;"> <div style="text-align: center;"> Adapters 188 Adapters 190 Collets 192 Pull studs 199 - 200 </div> <div style="text-align: center;"> FZS </div> <div style="text-align: center;"> FZA </div> <div style="text-align: center;"> ER </div> <div style="text-align: center;"> C </div> </div>											
Norm							DIN-69871 A		JIS B6339		
Internal cooling											
Shank	Adapters	D	A	H	M	↕		INDEX		INDEX	
						(-)	(+)				
ISO30	FZ19	19	38	60	M2-M12	9	9	R-OGK-ISO30/FZ19	○		
ISO30	FZ31	31	55	101	M6-M20	15	15	R-OGK-ISO30/FZ31	○		
ISO40	FZ19	19	38	60	M2-M12	9	9	R-OGK-ISO40/FZ19	●		
ISO40	FZ31	31	55	100	M6-M20	15	15	R-OGK-ISO40/FZ31	●		
ISO40	FZ48	48	79	138	M14-M33	24	24	R-OGK-ISO40/FZ48	○		
ISO40	FZ60	60	98	154	M22-M48	26	26	R-OGK-ISO40/FZ60	○		
ISO50	FZ19	19	38	62	M2-M12	9	9	R-OGK-ISO50/FZ19	○		
ISO50	FZ31	31	55	83	M6-M20	15	15	R-OGK-ISO50/FZ31	●		
ISO50	FZ48	48	79	133	M14-M33	24	24	R-OGK-ISO50/FZ48	●		
ISO50	FZ60	60	98	147	M22-M48	26	26	R-OGK-ISO50/FZ60	●		
BT30	FZ19	19	38	63	M2-M12	9	9			R-OGK-BT30/FZ19	○
BT30	FZ31	31	55	96	M6-M20	15	15			R-OGK-BT30/FZ31	○
BT40	FZ19	19	38	68	M2-M12	9	9			R-OGK-BT40/FZ19	●
BT40	FZ31	31	55	93	M6-M20	15	15			R-OGK-BT40/FZ31	●
BT40	FZ48	48	79	138	M14-M33	24	24			R-OGK-BT40/FZ48	○
BT40	FZ60	60	98	157	M22-M48	26	26			R-OGK-BT40/FZ60	○
BT50	FZ19	19	38	80	M2-M12	9	9			R-OGK-BT50/FZ19	○
BT50	FZ31	31	55	102	M6-M20	15	15			R-OGK-BT50/FZ31	●
BT50	FZ48	48	79	133	M14-M33	24	24			R-OGK-BT50/FZ48	○
BT50	FZ60	60	98	147	M22-M48	26	26			R-OGK-BT50/FZ60	○



OGKC version with internal cooling on request



								HSK	VDI		
Accessories											
Norm								DIN-69893 A	DIN-69880		
Internal cooling											
Shank	Adapters	D	A	H	M	↕		INDEX		INDEX	
						(-)	(+)				
HSK50	FZ19	19	41	72	M2-M12	7,5	7,5	R-OGK-HSK50/FZ19	○		
HSK50	FZ31	31	60	110	M6-M20	10	10	R-OGK-HSK50/FZ31	○		
HSK63	FZ19	19	41	72	M2-M12	7,5	7,5	R-OGK-HSK63/FZ19	●		
HSK63	FZ31	31	60	110	M6-M20	10	10	R-OGK-HSK63/FZ31	●		
HSK63	FZ48	48	86	141	M14-M33	17,5	17,5	R-OGK-HSK63/FZ48	○		
HSK80	FZ19	19	41	75	M2-M12	7,5	7,5	R-OGK-HSK80/FZ19	○		
HSK80	FZ31	31	60	95	M6-M20	10	10	R-OGK-HSK80/FZ31	○		
HSK80	FZ48	48	86	141	M14-M33	17,5	17,5	R-OGK-HSK80/FZ48	○		
HSK100	FZ19	19	41	80	M2-M12	7,5	7,5	R-OGK-HSK100/FZ19	○		
HSK100	FZ31	31	60	100	M6-M20	10	10	R-OGK-HSK100/FZ31	○		
HSK100	FZ48	48	86	141	M14-M33	17,5	17,5	R-OGK-HSK100/FZ48	○		
VDI20	FZ19	19	38	55	M2-M12	9	9			R-OGK-VDI20/FZ19	○
VDI20	FZ31	31	55	77	M6-M20	15	15			R-OGK-VDI20/FZ31	○
VDI25	FZ19	19	38	55	M2-M12	9	9			R-OGK-VDI25/FZ19	●
VDI25	FZ31	31	55	77	M6-M20	15	15			R-OGK-VDI25/FZ31	●
VDI30	FZ19	19	38	55	M2-M12	9	9			R-OGK-VDI30/FZ19	●
VDI30	FZ31	31	55	77	M6-M20	15	15			R-OGK-VDI30/FZ31	●
VDI40	FZ19	19	38	55	M2-M12	9	9			R-OGK-VDI40/FZ19	○
VDI40	FZ31	31	55	77	M6-M20	15	15			R-OGK-VDI40/FZ31	●
VDI40	FZ48	48	79	110	M14-M33	24	24			R-OGK-VDI40/FZ48	○
VDI50	FZ48	48	79	110	M14-M33	24	24			R-OGK-VDI50/FZ48	○



OGKC version with internal cooling on request

								WELDON	POLYGONAL				
Accessories													
<div style="display: flex; justify-content: space-around; align-items: flex-start;"> <div style="text-align: center;"> <p>Adapters 188</p> <p>FZS</p> </div> <div style="text-align: center;"> <p>Adapters 190</p> <p>FZA</p> </div> <div style="text-align: center;"> <p>Collets 192</p> <p>ER</p> </div> </div>								DIN-1835 B+E		ISO 26623-1			
Norm													
Internal cooling													
Shank	Adapters	D	A	H	M	↔		INDEX		INDEX			
						(-)	(+)						
W20	FZ19	19	38	41	M2-M12	9	9	R-OGK-W20/FZ19	○				
W20	FZ31	31	55	63	M6-M20	15	15	R-OGK-W20/FZ31	○				
W25	FZ19	19	38	41	M2-M12	9	9	R-OGK-W25/FZ19	●				
W25	FZ31	31	55	63	M6-M20	15	15	R-OGK-W25/FZ31	●				
W32	FZ19	19	38	41	M2-M12	9	9	R-OGK-W32/FZ19	○				
W32	FZ31	31	55	63	M6-M20	15	15	R-OGK-W32/FZ31	●				
W32	FZ48	48	79	109	M14-M33	24	24	R-OGK-W32/FZ48	○				
W40	FZ19	19	38	41	M2-M12	9	9	R-OGK-W40/FZ19	○				
W40	FZ31	31	55	63	M6-M20	15	15	R-OGK-W40/FZ31	○				
W40	FZ48	48	79	98	M14-M33	24	24	R-OGK-W40/FZ48	○				
C40	FZ19	19	41	48	M2-M12	7,5	7,5			R-OGK-C40/FZ19	○		
C40	FZ31	31	60	71	M6-M20	10	10			R-OGK-C40/FZ31	○		
C50	FZ19	19	41	48	M2-M12	7,5	7,5			R-OGK-C50/FZ19	○		
C50	FZ31	31	60	71	M6-M20	10	10			R-OGK-C50/FZ31	○		
C63	FZ19	19	41	73	M2-M12	7,5	7,5			R-OGK-C63/FZ19	○		
C63	FZ31	31	60	97	M6-M20	10	10			R-OGK-C63/FZ31	○		
C63	FZ48	48	86	124	M12-M33	17,5	17,5			R-OGK-C63/FZ48	○		
C80	FZ19	19	41	45	M2-M12	7,5	7,5			R-OGK-C80/FZ19	○		
C80	FZ31	31	60	60	M6-M20	10	10			R-OGK-C80/FZ31	○		
C80	FZ48	48	86	107	M12-M33	17,5	17,5			R-OGK-C80/FZ48	○		



OGKC version with internal cooling on request



Information:

- For machines with the right spindle rotation
 - Toolholder has axial compensation for compression, extension and safety clutch
- $I = U / U_r$
 U - tapping speed
 U_r - reversing speed

Accessories

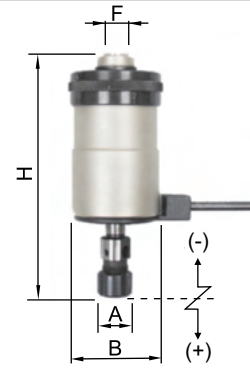

Norm

JT6 / M20 (+ MK DIN-228 B)

F	Collet	H	B	A	U _{max} [1/min]	I	M	In box		INDEX	
								RF	TM		
JT6	RF15	134	55	23	1500	1,6	M2-M7	J116, J117	MK1, MK3	R-OGN-JT6/RF15-Z	•
JT6	RF23	158	75	28	1000	1,75	M5-M12	J421, J422	MK3, MK4	R-OGN-JT6/RF23-Z	•
M20	RF32	205	91	40	600	1,7	M5-M18	J441, J445	MK3, MK4	R-OGN-M20/RF32-Z	•



Toolholder is sold in a set with accessories - details above in the table



Information:

- Adapters with safety clutch are intended for OGK holders with axial compensation
- Safety clutch can prevent the tool from damage in case of a large increase of cutting forces



Size					FZS13	FZS19	FZS31	FZS48	FZS60
d / A / H / h					13 / 23 / 21 / 6	19 / 32 / 25 / 8	31 / 50 / 34 / 4	48 / 72 / 45 / 1	60 / 95 / 68 / 3
M	DIN	D	∅	INDEX	R-FZS13	R-FZS19	R-FZS31	R-FZS48	R-FZS60
M 2	371	2,8	2,1	M2 D2,8 DIN	○	●			
M 3	371	3,5	2,7	M3 D3,5 DIN	○	●			
M 4	371	4,5	3,4	M4 D4,5 DIN	○	●			
M 5	371	6	4,9	M5 D6 DIN	○	●			
M 6	371	6	4,9	M6 D6 DIN	○	●	●		
M 8	371	8	6,2	M8 D8 DIN		●	●		
M 8	376	6	4,9	M8 D6 DIN		○	○		
M 10	371	10	8	M10 D10 DIN		●	●	○	
M 10	376	7	5,5	M10 D7 DIN		○	○		
M 12	376	9	7	M12 D9 DIN		●	●	○	
M 14	376	11	9	M14 D11 DIN		○	●	●	
M 16	376	12	9	M16 D12 DIN			●	○	
M 18	376	14	11	M18 D14 DIN			●	●	
M 20	376	16	12	M20 D16 DIN			●	○	○
M 22-M 24	376	18	14,5	M24 D18 DIN			●	●	○
M 27	376	20	16	M27 D20 DIN			○	●	○
M 30	376	22	18	M30 D22 DIN				○	○
M 33	376	25	20	M33 D25 DIN				○	○
M 36	376	28	22	M36 D28 DIN					●
M 39	376	32	24	M39 D32 DIN					○
M 42	376	32	24	M42 D32 DIN					●
M 45	376	36	29	M45 D36 DIN					○
M 48	376	36	29	M48 D36 DIN					○



Extended version FZSL of quick-change adapters and FL extensions on request



Recommended torque values for safety clutch p. 312



Information:

- Adapters are intended for OGK and OG holders

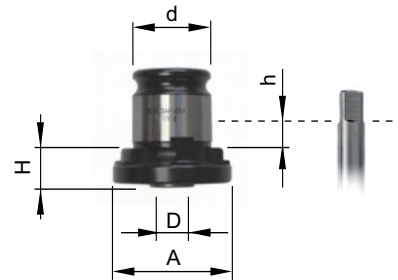

Size					FZ13	FZ19	FZ31	FZ48	FZ60
d / A / H / h					13 / 22 / 7 / 8	19 / 30 / 7 / 10	31 / 46 / 11 / 19	48 / 68 / 14 / 25	60 / 83 / 42 / 29
M	DIN	D	∅	INDEX	R-FZ13	R-FZ19	R-FZ31	R-FZ48	R-FZ60
M 2	371	2,8	2,1	M2 D2,8 DIN	○	○			
M 3	371	3,5	2,7	M3 D3,5 DIN	○	●			
M 4	371	4,5	3,4	M4 D4,5 DIN	○	●			
M 5, M6	371	6	4,9	M6 D6 DIN	○	●	●		
M 8	371	8	6,2	M8 D8 DIN		●	●		
M 10	371	10	8	M10 D10 DIN		●	●		
M 12	376	9	7	M12 D9 DIN		●	●		
M 14	376	11	9	M14 D11 DIN		○	○	○	
M 16	376	12	9	M16 D12 DIN			●	○	
M 18	376	14	11	M18 D14 DIN			○	○	
M 20	376	16	12	M20 D16 DIN			●	○	
M 22, M24	376	18	14,5	M24 D18 DIN			○	○	○
M 27	376	20	16	M27 D20 DIN				○	○
M 30	376	22	18	M30 D22 DIN				○	○
M 33	376	25	20	M33 D25 DIN				○	○
M 36	376	28	22	M36 D28 DIN					○
M 39, M42	376	32	24	M42 D32 DIN					○
M 45, M48	376	36	29	M48 D36 DIN					○



Extended version FZSL of quick-change adapters and FL extensions on request



Quick-change adapters FZN for dies on request



Information:

- Adapters are intended for OGK and OG holders
- In ER standard tap clamping - **adapter has fastening screws**

**After each change of the tap, it is necessary to tighten the Adapters.*



Accessories



Size	Collet	H	h	A	d	D	M	INDEX	
FZA19	ER16	29,5	8,5	28	19	2-10	M3-M12	R-FZA19/ER16	•
FZA31	ER25	38,5	15	42	31	2-16	M6-M20	R-FZA31/ER25	•

Information:

- Reductions are intended for OGK and OG holders to connect FZS, FZ quick-change adapters and FZA Adapters

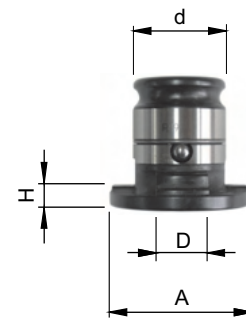

Reduction	H	A	d	D	INDEX	
19/13	6	30	19	13	R-FR19/13	○
31/19	8,5	46	31	19	R-FR31/19	•
48/31	7	68	48	31	R-FR48/31	•
60/48	13	92	60	48	R-FR60/48	○



DIN-6499

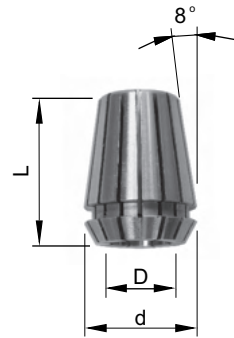

Size				ER16	ER20	ER25	ER32	ER40	ER50
d / L				17 / 27,5	21 / 31,5	26 / 34	33 / 40	41 / 46	52 / 60
D	M		INDEX	R-ER16	R-ER20	R-ER25	R-ER32	R-ER40	R-ER50
	DIN 371	DIN 376							
2			D2	●	●	●	●		
3	M2-M2,5	M3,5-M4	D3	●	●	●	●	○	
4	M3-M3,5	M5	D4	●	●	●	●	○	
5	M4	M6	D5	●	●	●	●	○	
6	M4,5-M5-M6	M8	D6	●	●	●	●	●	○
7	M7	M9-M10	D7	●	●	●	●	○	○
8	M8	M11	D8	●	●	●	●	●	○
9	M9	M12	D9	●	●	●	●	●	○
10	M10		D10	●	●	●	●	●	○
11		M14	D11		○	●	●	●	○
12		M16	D12		●	●	●	●	○
13		M16	D13		○	●	●	○	○
14		M18	D14			●	●	●	○
15		M18	D15			●	●	○	○
16		M20	D16			●	●	●	○
18		M22-M24	D18				●	●	○
20		M27	D20				●	●	○
22		M30	D22					●	○
25		M33	D25					●	○
28		M36	D28					●	○
32		M39-42	D32						○

9



Collets set on p. 261



DIN-6499

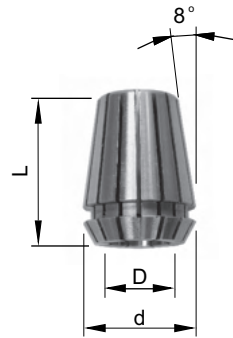

Size					ERC16	ERC20	ERC25	ERC32	ERC40	ERC50
d / L					17 / 27,5	21 / 31,5	26 / 34	33 / 40	41 / 46	52 / 60
D	∅	M		INDEX	R-ERC16	R-ERC20	R-ERC25	R-ERC32	R-ERC40	R-ERC50
		DIN 371	DIN 376							
3,5	2,7	M3	M4-M4,5	D3,5	○	○	●	○		
4,0	3,0	M3,5		D4	○	○	○	○		
4,5	3,4	M4	M6	D4,5	○	○	●	○		
5,0	4,0			D5	○	○	○	○		
5,5	4,3		M7	D5,5	○	○	○	○		
6,0	4,9	M4,5-M5-M6	M8	D6	●	●	●	●	○	
7,0	5,5	M7	M9-M10	D7	○	○	●	●	○	
8,0	6,2	M8	M11	D8	●	●	●	●	○	○
9,0	7,0	M9	M12	D9		○	●	●	○	○
10,0	8,0	M10		D10		●	●	●	○	○
11,0	9,0		M14	D11			○	●	○	○
12,0	9,0		M16	D12			●	●	●	○
14,0	11,0		M18	D14				●	○	○
16,0	12,0		M20	D16				●	●	○
18,0	14,5		M22-M24	D18					○	○
20,0	16,0		M27	D20					○	○
22,0	18,0		M30	D22						○
25,0	20,0		M33	D25						○
28,0	22,0		M36	D28						○
32,0	24,0		M39-42	D32						○



**MAX
25 BAR**
DIN-6499

Size			ERG16	ERG20	ERG25	ERG32	ERG40	
d / L			17 / 27,5	21 / 31,5	26 / 34	33 / 40	41 / 46	
D	M		INDEX	R-ERG16	R-ERG20	R-ERG25	R-ERG32	R-ERG40
	DIN 371	DIN 376						
3	M2-M2,5	M3,5-M4	D3	○	○	○	○	
4	M3-M3,5	M5	D4	○	○	○	○	○
5	M4	M6	D5	○	○	○	○	○
6	M4,5-M5-M6	M8	D6	○	○	●	●	○
7	M7	M9-M10	D7	○	○	○	○	○
8	M8	M11	D8	○	○	●	●	○
9	M9	M12	D9	○	○	○	○	○
10	M10		D10	○	○	●	●	○
11		M14	D11		○	○	○	○
12		M16	D12		○	●	●	○
13		M16	D13		○	○	○	○
14		M18	D14		○	●	●	○
15		M18	D15			○	○	○
16		M20	D16			●	●	○
18		M22-M24	D18				○	○
20		M27	D20				●	○
22		M30	D22					○
25		M33	D25					○

Rubber sealed collets with square drive for taps
**MAX
25 BAR**
DIN-6499

Size			ERCG16	ERCG20	ERCG25	ERCG32	ERCG40		
d / L			17 / 27,5	21 / 31,5	26 / 34	33 / 40	41 / 46		
D	□	M		INDEX	R-ERCG16	R-ERCG20	R-ERCG25	R-ERCG32	R-ERCG40
		DIN 371	DIN 376						
4	3,0	M3,5		D4	○	○	●	○	
4,5	3,4	M4	M6	D4,5	○	○	○	○	
5	4			D5	○	○	●	○	
5,5	4,3		M7	D5,5	○	○	○	○	
6	4,9	M4,5-M5-M6	M8	D6	○	○	○	○	
7	5,5	M7	M9-M10	D7	●	●	●	●	○
8	6,2	M8	M11	D8	○	○	●	●	○
9	7	M9	M12	D9	●	●	●	●	○
10	8	M10		D10		○	●	●	○
11	9		M14	D11		●	●	●	○
12	9		M16	D12			○	●	○
14	11		M18	D14			●	●	●
16	12		M20	D16				●	○
18	14,5		M22-M24	D18				●	●
20	16			D20					○

Sealing Gaskets



Seals ER40 and ER50 also available on request

Sealing Gaskets to ER20	INDEX
3-3.5mm	R-U20/D3
3.5-4mm	R-U20/D3,5
4-4.5mm	R-U20/D4
4.5-5mm	R-U20/D4,5
5-5.5mm	R-U20/D5
5.5-6mm	R-U20/D5,5
6-6.5mm	R-U20/D6
6.5-7mm	R-U20/D6,5
7-7.5mm	R-U20/D7
7.5-8mm	R-U20/D7,5
8-8.5mm	R-U20/D8
8.5-9mm	R-U20/D8,5
9-9.5mm	R-U20/D9
9.5-10mm	R-U20/D9,5
10-10.5mm	R-U20/D10
10.5-11mm	R-U20/D10,5
11-11.5mm	R-U20/D11
11.5-12mm	R-U20/D11,5
12-12.5mm	R-U20/D12

Clamping nuts acc. to DIN 6499 standard without internal coolant sealing

Note: Max. Nm shows the maximum allowed tightening torque for each respective nut size.

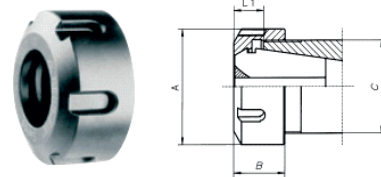

Sealing Gaskets to ER25	INDEX
3-3.5mm	R-U25/D3
3.5-4mm	R-U25/D3,5
4-4.5mm	R-U25/D4
4.5-5mm	R-U25/D4,5
5-5.5mm	R-U25/D5
5.5-6mm	R-U25/D5,5
6-6.5mm	R-U25/D6
6.5-7mm	R-U25/D6,5
7-7.5mm	R-U25/D7
7.5-8mm	R-U25/D7,5
8-8.5mm	R-U25/D8
8.5-9mm	R-U25/D8,5
9-9.5mm	R-U25/D9
9.5-10mm	R-U25/D9,5
10-10.5mm	R-U25/D10
10.5-11mm	R-U25/D10,5
11-11.5mm	R-U25/D11
11.5-12mm	R-U25/D11,5
12-12.5mm	R-U25/D12
12.5-13mm	R-U25/D12,5
13-13.5mm	R-U25/D13
13.5-14mm	R-U25/D13,5
14-14.5mm	R-U25/D14
14.5-15mm	R-U25/D14,5
15-15.5mm	R-U25/D15
15.5-16mm	R-U25/D15,5
16-16.5mm	R-U25/D16

Type	A mm	B mm	max. Nm	INDEX
ER11	19	11,3	30	R-NT11-SE
ER16	28	17,5	70	R-NT16-SE
ER20	34	19	100	R-NT20-SE

Type	A mm	B mm	max. Nm	INDEX
ER25	42	20	130	R-NT25-S
ER40	63	25,5	220	R-NT40-S
ER50	78	35,3	300	R-NT50-S





Information:

- Use of reduction collets causes necessity to reduce maximum speed to 50%

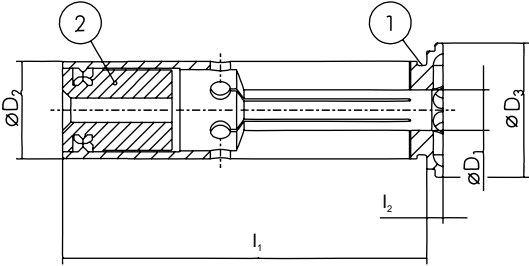

Size		TR20	TR32
d / L		20 / 54	32 / 64
D	INDEX	R-TR20	R-TR32
3	D3	○	○
4	D4	○	○
5	D5	○	○
6	D6	○	○
7	D7	○	○
8	D8	○	○
9	D9	○	○
10	D10	○	○
11	D11	○	○
12	D12	○	○
13	D13	○	○
14	D14	○	○
15	D15	○	○
16	D16	○	○
17	D17	○	○
18	D18	○	○
19	D19		○
20	D20		○
21	D21		○
22	D22		○
23	D23		○
24	D24		○
25	D25		○
26	D26		○
28	D28		○

Basic accessories							TRH20	TRH20-EK
① O-ring sealing ② Adjustable back stop for length adjustment								
								
Cooling							-	EK with curtain cooling
D ₁	D ₂	D ₃	l ₁	l ₂	m	INDEX	R-TRH20	R-TRH20-EK
3,0	20	24	50,5	2,0	0,1	D3	○	○
4,0	20	24	50,5	2,0	0,1	D4	○	○
5,0	20	24	50,5	2,0	0,1	D5	○	○
6,0	20	24	50,5	2,0	0,1	D6	○	○
7,0	20	24	50,5	2,0	0,1	D7	○	○
8,0	20	24	50,5	2,0	0,1	D8	○	○
9,0	20	24	50,5	2,0	0,1	D9	○	○
10,0	20	24	50,5	2,0	0,1	D10	○	○
11,0	20	24	50,5	2,0	0,1	D11	○	○
12,0	20	24	50,5	2,0	0,1	D12	○	○
13,0	20	24	50,5	2,0	0,1	D13	○	○
14,0	20	24	50,5	2,0	0,1	D14	○	○
15,0	20	24	50,5	2,0	0,1	D15	○	○
16,0	20	24	50,5	2,0	0,1	D16	○	○



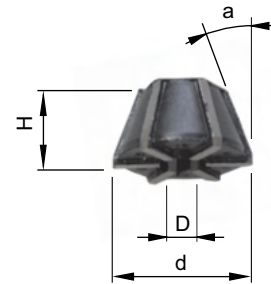

Size	d	H	a	D	M	INDEX	
RF15	15	12	13	2,5-4,5	M2-M4	R-RF15/J116	●
RF15	15	12	13	4,5-6,5	M4-M7	R-RF15/J117	●
RF23	23	13	20	3,5-6,5	M5-M6	R-RF23/J421	●
RF23	23	13	20	6,5-10,0	M6-M12	R-RF23/J422	●
RF32	32,5	16	22,5	4,5-10,0	M8-M12	R-RF32/J441	●
RF32	32,5	16	22,5	10,0-15,0	M10-M18	R-RF32/J445	●

Information:

- Application: for tool holders with ISO shank according to DIN-69871
- IK- with central cooling

C ISO A

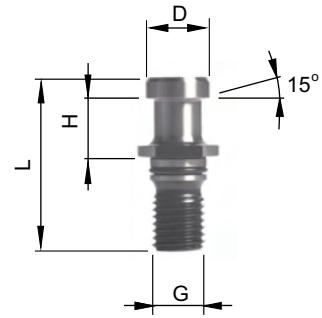

Norm

ISO-7388/2A

Size ISO	IK	O-RING	L	H	D	G	INDEX	
30			44	19	12	M12	R-C-ISO-A-30	o
30	•		44	19	12	M12	R-C-ISO-A-30-IK	o
40		•	54	20	19	M16	R-C-ISO-A-40	o
40	•	•	54	20	19	M16	R-C-ISO-A-40-IK	o
50		•	74	25	28	M24	R-C-ISO-A-50	o
50	•	•	74	25	28	M24	R-C-ISO-A-50-IK	o

Information:

- Application: for tool holders with ISO shank according to DIN-69871
- IK - with central cooling

C ISO B

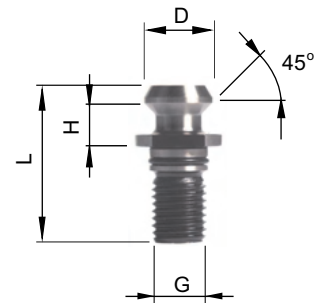

Norm

ISO-7388/2B

Size ISO	IK	O-RING	L	H	D	G	INDEX	
30			34,0	8,15	13,35	M12	R-C-ISO-B-30	o
30	•		34,0	8,15	13,35	M12	R-C-ISO-B-30-IK	o
40		•	44,5	11,15	18,95	M16	R-C-ISO-B-40	•
40	•	•	44,5	11,15	18,95	M16	R-C-ISO-B-40-IK	•
50		•	65,5	17,95	29,10	M24	R-C-ISO-B-50	o
50	•	•	65,5	17,95	29,10	M24	R-C-ISO-B-50-IK	o



Information:

- Application: for tool holders with ISO shank according to DIN-69871
- IK- with central cooling

C DIN

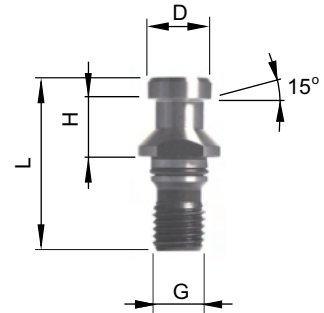

Norm

DIN-69872

Size ISO	IK	O-RING	L	H	D	G	INDEX	
30			44	19	13	M12	R-C-DIN-30	○
30	●		44	19	13	M12	R-C-DIN-30-IK	○
40		●	54	20	19	M16	R-C-DIN-40	●
40	●	●	54	20	19	M16	R-C-DIN-40-IK	●
50		●	74	25	28	M24	R-C-DIN-50	○
50	●	●	74	25	28	M24	R-C-DIN-50-IK	○

Information:

- Application: for tool holders with ISO shank according to MAS-BT
- IK- with central cooling

C BT

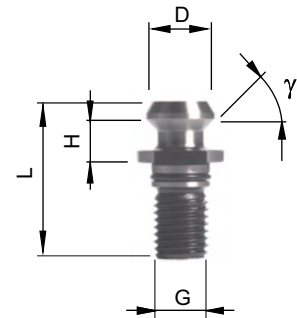







Size MAS-BT	IK	O-RING	L	H	D	G	γ	INDEX	
30			43	18	11	M12	45	R-C-BT-30/45	○
30	●		43	18	11	M12	45	R-C-BT-30/45-IK	○
30			43	18	11	M12	60	R-C-BT-30/60	○
30	●		43	18	11	M12	60	R-C-BT-30/60-IK	○
40		●	60	28	15	M16	45	R-C-BT-40/45	●
40	●	●	60	28	15	M16	45	R-C-BT-40/45-IK	●
40		●	60	28	15	M16	60	R-C-BT-40/60	○
40	●	●	60	28	15	M16	60	R-C-BT-40/60-IK	○
40		●	60	28	15	M16	90	R-C-BT-40/90	○
40	●	●	60	28	15	M16	90	R-C-BT-40/90-IK	○
50		●	85	35	23	M24	45	R-C-BT-50/45	○
50	●	●	85	35	23	M24	45	R-C-BT-50/45-IK	○
50		●	85	35	23	M24	60	R-C-BT-50/60	○
50	●	●	85	35	23	M24	60	R-C-BT-50/60-IK	○
50		●	85	35	23	M24	90	R-C-BT-50/90	○
50	●	●	85	35	23	M24	90	R-C-BT-50/90-IK	○

TOOL KITS











	Hand taps set	253 - 256
	Machine taps set	257 - 259
	HSSE Drills set	259
	Countersinks set	260
	Drills set to remove broken taps	260
	End mills set	261
	Collets set	261 - 262
	Gauges set	262 - 263

CZD-40 HSS M3÷M20
INDEX Z1-040011-0000



CONTENTS	Taps	Dies	Screw pitch gauge	Taps wrench	Die stock	Screwdriver
	DIN-352 HSS dla M3÷M12 DIN-352/2 HSS dla M14÷M20 	DIN-EN 22 568 HSS 800 	MWGa 	PBPc 	PBGa 	RWWe 
M3 M4 M5 M6 M7, M8, M10 M12 M14 M16 M20	Ø25 x 9: M3 M4 M5 M6 M7 M8 M10 Ø38 x 14: M12 M14 M16 M20	0,4 ÷ 6 mm	Nr 2 zm.: 2,5 ÷ 9 mm Nr 3: 4,9 ÷ 14 mm	Ø25 x 9 mm Ø38 x 14 mm	4 x 90 mm	
DIMENSIONS	475 x 255 x 40 mm					
WEIGHT	3,4 kg					

CZD-85 HSS M3÷M24
INDEX Z1-085011-0000





CONTENTS	Taps	Dies	Screw pitch gauge	Taps wrenches	Die stocks	„T” type wrench	Screwdriver	Distance ring
	DIN-352 HSS - M3÷M12 DIN-352/2 HSS - M14÷M24 DIN-2181/2 HSS - MF≥14x1,25 	DIN-EN 22 568 HSS 800 	MWGa 	PBPc 	PBGa 		RWWe 	
M3, M4, M5, M6, M8, M10, M12, M14, M16, M18, M20, M22, M24, M8x1, M10x1, M12x1,25, M12x1,5, M14x1,25, M14x1,5, M16x1,5, M18x1,5, M20x1,5, M22x1,5, M24x1,5	M3 M4 M5 M6 M8 M10 M12 M14 M16 M18 M20 M22 M24 M8x1 M10x1 M12x1,25 M12x1,5 M14x1,25 M14x1,5 M16x1,5 M18x1,5 M20x1,5 M22x1,5 M24x1,5	0,4 ÷ 6 mm	Nr 2 zm.: 2,5 ÷ 9 mm Nr 3: 4,9 ÷ 14 mm	Ø25 x 9 mm Ø38 x 14 mm Ø45 x 18 mm Ø55 x 22 mm	Nr 1 (M2 ÷ M5)	4 x 90 mm	38 x 2 45 x 2 55 x 3	
DIMENSIONS	550 x 380 x 70 mm							
WEIGHT	12 kg							

10





CZB-29 HSS M3÷M12
INDEX Z1-029012-0000

CONTENTS	Taps	Dies
	DIN-352/3 HSS	DIN-EN 22 568 HSS 800
		
M3 M4 M5 M6 M8 M10 M12	∅25 x 9: M3 M4 M5 M6 M8 M10 M12	
DIMENSIONS	270 x 230 x 30 mm	
WEIGHT	0,9 kg	



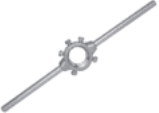

CZB-29W HSS M3÷M12
INDEX Z1-029112-0000

CONTENTS	Taps	Dies	Drills
	DIN-352/2 HSS	DIN-EN 22 568 HSS 800	DIN-338 N HSS
			
M3, M4, M5, M6, M8, M10, M12	∅25 x 9: M3, M4, M5, M6, M8, M10, M12	∅2,5; ∅3,3; ∅4,2; ∅5,0; ∅6,8; ∅8,5; ∅10,2	
DIMENSIONS	340 x 290 x 40 mm		
WEIGHT	1,2 kg		

CZB-31 HSS M3÷M12
INDEX Z1-031012-0000





CONTENTS	Taps	Dies	Tap wrenches	Die stocks	Screwdriver
	DIN-352/3 HSS	DIN-EN 22 568 HSS 800	PBPc	PBGa	RWWe
					
M3 M4 M5 M6 M8 M10 M12	∅25 x 9: M3 M4 M5 M6 M8 M10 M12	Nr 1,5: 2,5 + 8 mm	∅25 x 9 mm	4 x 90 mm	
DIMENSIONS	340 x 290 x 40 mm				
WEIGHT	1,6 kg				

CZB-31 INOX M3÷M12
INDEX Z2-031012-0000

CONTENTS	Taps	Dies	Tap wrenches	Die stocks	Screwdriver
	DIN-352/3 HSSE INOX	DIN-EN 22 568 HSSE INOX	PBPc	PBGa	RWWe
					
M3 M4 M5 M6 M8 M10 M12	∅25 x 9: M3 M4 M5 M6 M8 M10 M12	Nr 1,5: 2,5 + 8 mm	∅25 x 9 mm	4 x 90 mm	
DIMENSIONS	340 x 290 x 40 mm				
WEIGHT	1,6 kg				









10

CZP-31 HSS mini M1÷M2,5
INDEX Z1-031115-0000





CONTENTS	Taps	Dies	Tap and die wrench
	DIN-352/2 HSS	DIN-EN 22 568 HSS	
			
	M1 M1,1 M1,2 M1,4 M1,6 M1,8 M2 M2,2 M2,5	Ø12 x 3: M1 M1,1 M1,2 M1,4 M1,6 M1,8 M2, Ø16 x 3: M2,2 M2,5	
DIMENSIONS	155 x 85 x 12 mm		
WEIGHT	0,2 kg		





CZP-7 BIT HSS M3÷M10
Z1-007020-0310

Designation	M Ød ₁	⬡	INDEX	Z1-007020
CZP-7 BIT HSS	M 3 ÷ M 10	1/4"	0310	●

<p>CZP-8 MasterTAP R45 HSSE-PM HL</p>	<p>CZP-8 MasterTAP B HSSE-PM HL</p>
<p>INDEX Z4-528M15-0310</p>	<p>INDEX Z4-118M15-0310</p>
	
<p>CONTENTS</p>	
<p>Taps</p>	
<p>MasterTAP 6HX DIN-371 C R45 HSSE-PM HL</p>	<p>MasterTAP 6HX DIN-371 B HSSE-PM HL</p>
 <p>M3 M4 M5 M6 M8 M10</p>	 <p>M3 M4 M5 M6 M8 M10</p>
<p>Dimensions 155 x 145 x 32 mm</p>	<p>Weight 0,2 kg</p>
<p>CZP-8 800X C R40 HSSE TN2</p>	<p>CZP-8 800X B HSSE TN2</p>
<p>INDEX Z2-513X15-0310</p>	<p>INDEX Z2-113X15-0310</p>
	
<p>CONTENTS</p>	
<p>Taps</p>	
<p>800X 6H DIN-371 C R40 HSSE TN2</p>	<p>800X 6H DIN-371 B HSSE TN2</p>
 <p>M3 M4 M5 M6 M8 M10</p>	 <p>M3 M4 M5 M6 M8 M10</p>
<p>800X 6H DIN-376 C R40 HSSE TN2</p>	<p>800X 6H DIN-376 B HSSE TN2</p>
 <p>M12</p>	 <p>M12</p>
<p>Dimensions 145 x 90 x 37 mm</p>	<p>Weight 0,2 kg</p>









<p>CZP-5 800X C R40 HSSE TN2</p>	<p>CZP-5 800X B HSSE TN2</p>
<p>INDEX Z2-X53520-0408</p>	<p>INDEX Z2-X53120-0408</p>
	
<p>CONTENTS</p>	
<p>Taps</p>	
<p>800X 6H DIN-371 C R40 HSSE TN2</p>	<p>800X 6H DIN-371 B HSSE TN2</p>
 <p>M4 M5 M6 M8</p>	 <p>M4 M5 M6 M8</p>
<p>Dimensions 120 x 80 x 45 mm</p>	<p>Weight 0,1 kg</p>

<p>CZP-5 R40 HSSE</p>	<p>CZP-5 B HSSE</p>
<p>INDEX Z2-055115-0408</p>	<p>INDEX Z2-051115-0408</p>
	
<p>CONTENTS</p>	
<p>Taps</p>	
<p>DIN-371-C ISO2(6H) R40 HSSE 800</p>	<p>DIN-371-B ISO2(6H) HSSE 800</p>
 <p>M4 M5 M6 M8</p>	 <p>M4 M5 M6 M8</p>
<p>Dimensions 120 x 80 x 45 mm</p>	<p>Weight 0,1 kg</p>

CZP-8 B HSSE OPTI OX	CZP-8 R40 HSSE OPTI OX	CZP-8 C HSSE OPTI OX
INDEX Z2-081015-0000	INDEX Z2-085015-0000	INDEX Z2-082015-0000
CONTENTS		
Taps		
DIN-371 B ISO2 (6H) HSSE OPTI OX	DIN-371 C ISO2 (6H) R40 HSSE OPTI OX	DIN-371 C ISO2 (6H) C HSSE OPTI OX
M3 M4 M5 M6 M8 M10	M3 M4 M5 M6 M8 M10	M3 M4 M5 M6 M8 M10
DIN-376 B ISO2 (6H) HSSE OPTI OX	DIN-376 C ISO2 (6H) R40 HSSE OPTI OX	DIN-376 C ISO2 (6H) C HSSE OPTI OX
M12	M12	M12
Dimensions		Weight
145 x 90 x 37 mm		0,2 kg

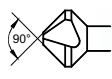
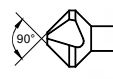
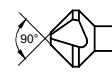
CZW-19 HSSE INOX TiN Ø1,0 ÷ Ø10	CZW-24 HSSE INOX TiN Ø1,0 ÷ Ø10,5	CZW-25 HSSE INOX TiN Ø1,0 ÷ Ø13
INDEX Z2-019315-0000	INDEX Z2-024315-0000	INDEX Z2-025315-0000
CONTENTS		
Steel drills		
DIMENSIONS		
1 1,5 2 2,5 3 3,5 4 4,5 5 5,5 6 6,5 7 7,5 8 8,5 9 9,5 10	1 1,5 2 2,5 3 3,5 4 4,5 5 5,5 6 6,5 7 7,5 8 8,5 9 9,5 10 + the dimensions of the thread 3,3 4,2 6,8 10,2 10,5	1 1,5 2 2,5 3 3,5 4 4,5 5 5,5 6 6,5 7 7,5 8 8,5 9 9,5 10 10,5 11 11,5 12 12,5 13



CZP-6 DIN-335-C Master-line Ø6,3÷Ø25 HSSE TC	CZP-6 DIN-335-C X-line Ø6,3÷Ø25 HSSE TN2	CZP-6 DIN-335-C Ø6,3÷Ø25 HSSE
INDEX Z2-065015-0000	INDEX Z2-065X15-0000	INDEX Z2-065S15-0000
		
		
CONTENTS		
Countersinks		
DIN-335-C HSSE TC	DIN-335-C HSSE TN2	DIN-335-C HSSE
		
6,3 10,4 16,5 20,5 25	6,3 10,4 16,5 20,5 25	6,3 10,4 16,5 20,5 25
Dimensions 145 x 100 x 42 mm		Weight 0,3 kg

WDG M3÷M12
INDEX W9-900002-0000

Drills to remove broken taps

WDG

CONTENTS



M3 | M4 | M5 | M6 | M8 | M10 | M12

DIMENSIONS

290 x 340 x 40 mm

WEIGHT

1,2 kg

10



MasterMill 440N 6-12 VHM TS	X-MILL 440N 6-12 VHM AT
INDEX Z9-44GMA0-0612	INDEX Z9-444XA0-0612
	
CONTENTS	
End mills	
MasterMill 440N VHM TS	X-MILL 440N VHM AT
 <p data-bbox="408 913 544 943">6 8 10 12</p>	 <p data-bbox="1046 913 1182 943">6 8 10 12</p>
Dimensions	Weight
155 x 145 x 32 mm	0,4 kg

R-ER11	R-ER16	R-ER20
INDEX: R-ER11-13BOX	INDEX: R-ER16-10BOX	INDEX: R-ER20-12BOX
		
Collet chunk		
Plastic box D.1÷7 x 0,5 mm	Plastic box D.1÷10 x 1 mm	Plastic box D.2÷13 x 1 mm

10



R-ER25	R-ER32	R-ER40
INDEX: R-ER25-15BOX	INDEX: R-ER32-18BOX	INDEX: R-ER40-23BOX
		
Collet chunk		
Aluminium Box D.2÷16 x 1 mm	Aluminium Box D.3÷20 x 1 mm	Aluminium Box D.4÷26 x 1 mm

CZD-8 MSRh M3÷M12		Index: Z3-200120-0312
Dimensions standard ISO 1502		
		
CONTENTS	Gauges set	
	MSRh 6g	
		
	M3 M4 M5 M6 M8 M10 M12	
DIMENSIONS	145 x 145 x 35 mm	
WEIGHT	0,5 kg	

10

CZD-8 MSBg M3÷M12

Index: Z3-302161-0312

Dimensions standard ISO 1502



CONTENTS	Gauges set
	MSBg 6H
	
	M3 M4 M5 M6 M8 M10 M12
DIMENSIONS	290 x 175 x 35 mm
WEIGHT	0,6 kg



ACCESSORIES



CATALOGUE PAGES

267 - 274

Facilities for threading	267
Tap wrenches, Extension sleeves, die stocks	268
Shank extensions for taps	269 - 271
Pneumatic tapping machines	272 - 273
Fast drill re-sharpening machine	274

TEREBOR

Speciment for threading

Application: for threading hard working steels especially:

- stainless steels,
- acidproff steels,
- hardening andd tempered steels



CAPACITY	INDEX
250 ml	T0-100110-0250
500 ml	T0-100110-0500
5 l	T0-100110-5000

VARIOCUT B 40

Oil for machining

Application: for threading tool steels an soft constructional steels



CAPACITY	INDEX
250 ml	T0-100340-0250
500 ml	T0-100340-0500
5 l	T0-100340-5000
200 l*	Na zapytanie

*For use in lathes

CIMTAP

Paste for threading

Application: for hand andd machine threadding of iron and non-iron metals



CAPACITY	INDEX
1 l	T0-100410-1000

Tap wrenches

Mark	□	l	M		INDEX
			ISO-529	DIN-352	
PBPc/m - 0	2 ÷ 4,5	125	M1 ÷ M5	M1 ÷ M4	V0-303000-0204
PBPc/m - 1	3,15 ÷ 6,3	205	M4 ÷ M8	M3 ÷ M11	V0-303010-0306
PBPc/m - 1,5	2,5 ÷ 7,1	205	M3 ÷ M9	M3 ÷ M12	V0-303015-0207
PBPc/m - 2	3,55 ÷ 9	305	M4,5 ÷ M14	M4,5 ÷ M16	V0-303020-0309
PBPc/m - 4	5,6 ÷ 16	395	M7 ÷ M27	M11 ÷ M27	V0-303040-0516
PBPc/m - 5	7 ÷ 20	700	M9 ÷ M30	M13 ÷ M32	V0-303050-0720

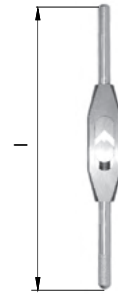

Tap wrenches type „T”

Mark	□	l	M		INDEX
			ISO-529	DIN-352	
PT Nr 1	2,0 ÷ 4,0	55	M1 ÷ M5	M1 ÷ M4	V0-310000-0205
PT Nr 1D	2,0 ÷ 4,0	200	M1 ÷ M5	M1 ÷ M4	V0-311000-0205
PT Nr 2	4,0 ÷ 7,1	90	M6 ÷ M12	M5 ÷ M12	V0-320000-0612
PT Nr 2D	4,0 ÷ 7,1	250	M6 ÷ M12	M5 ÷ M12	V0-321000-0612
PT Nr 3	9,0 ÷ 11,2	110	M14 ÷ M20	M14 ÷ M18	V0-330000-1420

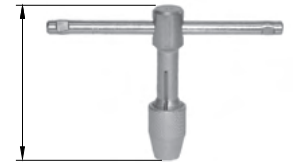

Tap wrenches with ratchet system

Mark	l	M	INDEX
PG Nr 1	85	M3 ÷ M6	V0-310500-0306
PG Nr 1 D	250	M3 ÷ M6	V0-311500-0306
PG Nr 2	110	M6 ÷ M12	V0-320500-0612
PG Nr 2 D	300	M6 ÷ M12	V0-321500-0612



Extension sleeves for taps

Mark	□	l	D	M		INDEX
				ISO-529	DIN-352	
PBNa - 5	5,0	110	11	M6		V0-200000-0050
PBNa - 6,3	6,3	120	14	M8, M11		V0-200000-0063
PBNa - 7,1	7,1	125	15	M9, M12		V0-200000-0071
PBNa - 8	8,0	130	17	M10		V0-200000-0080
PBNa - 9	9,0	130	19	M14	M14, M16	V0-200000-0090
PBNa - 10	10,0	140	21	M16		V0-200000-0100

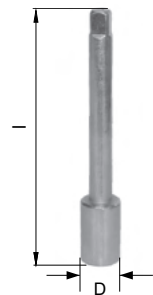

Die stocks

Mark	l	M	INDEX
PBGa/m - 16x5	160	M1 ÷ M2,5	V0-103000-1605
PBGa/m - 20x5	185	M3 ÷ M6	V0-103000-2005
PBGa/m - 25x9	220	M7 ÷ M9	V0-103000-2509
PBGa/m - 30x11	260	M10 ÷ M11	V0-103000-3011
PBGa/m - 38x14	310	M12 ÷ M14	V0-103000-3814
PBGa/m - 45x18	400	M16 ÷ M20	V0-103000-4518
PBGa/m - 55x22	500	M22 ÷ M24	V0-103000-5522
PBGa/m - 65x25	560	M27 ÷ M36	V0-103000-6525

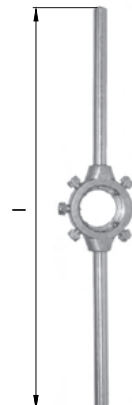

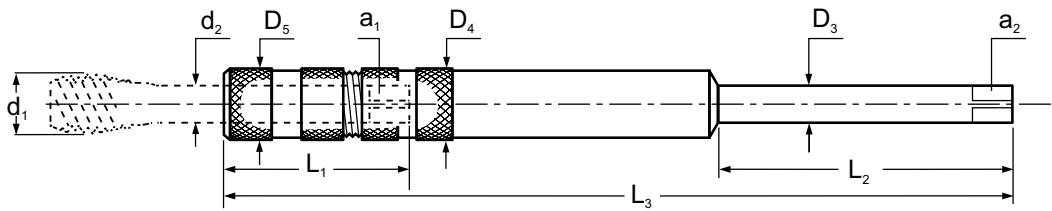

Short

Mark	d ₁		d ₂	D ₃	D ₄ =D ₅	L ₁	L ₂	L ₃	a ₁	a ₂	INDEX
	DIN-371	DIN-376									
PBNm 2,8/2,1-6/4,9-130	M2 - M2,6	M4	2,8	6	6,1	22	60	130	2,1	4,9	V0-211130-0206
PBNm 3,5/2,7-6/4,9-130	M3	M4,5 - M5	3,5	6	7,5	23	60	130	2,7	4,9	V0-211130-0306
PBNm 4,5/3,4-6/4,9-130	M4	M6	4,5	6	8,4	23	60	130	3,4	4,9	V0-211130-0406
PBNm 6/4,9-7/5,5-130	M4,5 - M6	M8	6	7	12,1	26	60	130	4,9	5,5	V0-211130-0607
PBNm 7/5,5-7/5,5-130	M7	M9 - M10	7	7	12,1	26	60	130	5,5	5,5	V0-211130-0707
PBNm 8/6,2-8/6,2-130	M8	M11	8	8	13	30	60	130	6,2	6,2	V0-211130-0808
PBNm 9/7-9/7-130	M9	M12	9	9	15	31	60	130	7	7	V0-211130-0909
PBNm 10/8-10/8-130	M10	-	10	10	15	33	60	130	8	8	V0-211130-1010
PBNm 11/9-11/9-130		M14	11	11	18	36	90	130	9	9	V0-211130-1111
PBNm 12/9-12/9-130		M16	12	12	18	36	90	130	9	9	V0-211130-1212
PBNm 14/11-14/11-200		M18	14	14	22	42	90	200	11	11	V0-211200-1414
PBNm 16/12-16/12-200		M20	16	16	22	42	90	200	12	12	V0-211200-1616
PBNm 18/14,5-18/14,5-200		M22/M24	18	18	26	43	100	200	14,5	14,5	V0-211200-1818
PBNm 20/16-20/16-200		M27	20	20	28	48	100	200	16	16	V0-211200-2020

Long

Mark	d ₁		d ₂	D ₃	D ₄ =D ₅	L ₁	L ₂	L ₃	a ₁	a ₂	INDEX
	DIN-371	DIN-376									
PBNm 2,8/2,1-6/4,9-230	M2-M2,6	M4	2,8	6	6,1	22	70	230	2,1	4,9	V0-211230-0206
PBNm 3,5/2,7-6/4,9-230	M3	M4,5-M5	3,5	6	7,5	23	70	230	2,7	4,9	V0-211230-0306
PBNm 4,5/3,4-6/4,9-230	M4	M6	4,5	6	8,4	23	70	230	3,4	4,9	V0-211230-0406
PBNm 6/4,9-7/5,5-230	M4,5 - M6	M8	6	7	12,1	26	70	230	4,9	5,5	V0-211230-0607
PBNm 7/5,5-7/5,5-230	M7	M9 - M10	7	7	12,1	26	70	230	5,5	5,5	V0-211230-0707
PBNm 8/6,2-8/6,2-230	M8	M11	8	8	13	30	80	230	6,2	6,2	V0-211230-0808
PBNm 9/7-9/7-230	M9	M12	9	9	15	31	80	230	7	7	V0-211230-0909
PBNm 10/8-10/8-230	M10	-	10	10	15	33	80	230	8	8	V0-211230-1010
PBNm 11/9-11/9-230		M14	11	11	18	36	90	230	9	9	V0-211230-1111
PBNm 12/9-12/9-230		M16	12	12	18	36	90	230	9	9	V0-211230-1212
PBNm 14/11-14/11-330		M18	14	14	22	42	90	330	11	11	V0-211330-1414
PBNm 16/12-16/12-330		M20	16	16	22	42	90	330	12	12	V0-211330-1616
PBNm 18/14,5-18/14,5-330		M22/M24	18	18	26	43	100	330	14,5	14,5	V0-211330-1818
PBNm 20/16-20/16-330		M27	20	20	28	48	100	330	16	16	V0-211330-2020

IK

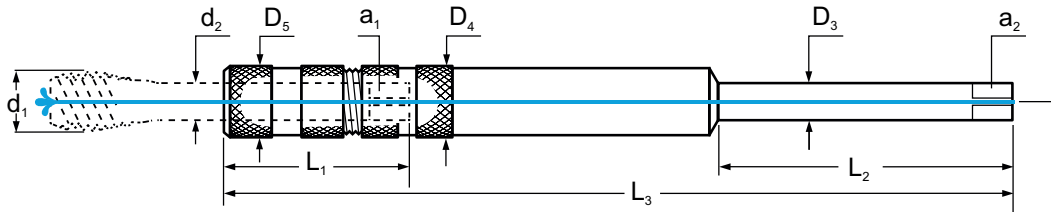

Short

Mark	d ₁		d ₂	D ₃	D ₄ =D ₅	L ₁	L ₂	L ₃	a ₁	a ₂	INDEX
	DIN-371	DIN-376									
PBNm 2,8/2,1-6/4,9-130	M2 - M2,6	M4	2,8	6	6,1	22	60	130	2,1	4,9	V0-211135-0206
PBNm 3,5/2,7-6/4,9-130	M3	M4,5 - M5	3,5	6	7,5	23	60	130	2,7	4,9	V0-211135-0306
PBNm 4,5/3,4-6/4,9-130	M4	M6	4,5	6	8,4	23	60	130	3,4	4,9	V0-211135-0406
PBNm 6/4,9-7/5,5-130	M4,5 - M6	M8	6	7	12,1	26	60	130	4,9	5,5	V0-211135-0607
PBNm 7/5,5-7/5,5-130	M7	M9 - M10	7	7	12,1	26	60	130	5,5	5,5	V0-211135-0707
PBNm 8/6,2-8/6,2-130	M8	M11	8	8	13	30	60	130	6,2	6,2	V0-211135-0808
PBNm 9/7-9/7-130	M9	M12	9	9	15	31	60	130	7	7	V0-211135-0909
PBNm 10/8-10/8-130	M10	-	10	10	15	33	60	130	8	8	V0-211135-1010
PBNm 11/9-11/9-130	-	M14	11	11	18	36	90	130	9	9	V0-211135-1111
PBNm 12/9-12/9-130	-	M16	12	12	18	36	90	130	9	9	V0-211135-1212
PBNm 14/11-14/11-200	-	M18	14	14	22	42	90	200	11	11	V0-211205-1414
PBNm 16/12-16/12-200	-	M20	16	16	22	42	90	200	12	12	V0-211205-1616
PBNm 18/14,5-18/14,5-200	-	M22/M24	18	18	26	43	100	200	14,5	14,5	V0-211205-1818
PBNm 20/16-20/16-200	-	M27	20	20	28	48	100	200	16	16	V0-211205-2020

Long

Mark	d ₁		d ₂	D ₃	D ₄ =D ₅	L ₁	L ₂	L ₃	a ₁	a ₂	INDEX
	DIN-371	DIN-376									
PBNm 6/4,9-7/5,5-230	M4,5 - M6	M8	6	7	12,1	26	70	230	4,9	5,5	V0-211235-0607
PBNm 7/5,5-7/5,5-230	M7	M9 - M10	7	7	12,1	26	70	230	5,5	5,5	V0-211235-0707
PBNm 8/6,2-8/6,2-230	M8	M11	8	8	13	30	80	230	6,2	6,2	V0-211235-0808
PBNm 9/7-9/7-230	M9	M12	9	9	15	31	80	230	7	7	V0-211235-0909
PBNm 10/8-10/8-230	M10	-	10	10	15	33	80	230	8	8	V0-211235-1010
PBNm 11/9-11/9-230	-	M14	11	11	18	36	80	230	9	9	V0-211235-1111
PBNm 12/9-12/9-230	-	M16	12	12	18	36	80	230	9	9	V0-211235-1212
PBNm 14/11-14/11-330	-	M18	14	14	22	42	90	330	11	11	V0-211335-1414
PBNm 16/12-16/12-330	-	M20	16	16	22	42	100	330	12	12	V0-211335-1616
PBNm 18/14,5-18/14,5-330	-	M22/M24	18	18	26	43	100	330	14,5	14,5	V0-211335-1818
PBNm 20/16-20/16-330	-	M27	20	20	28	48	100	330	16	16	V0-211335-2020

IK-H6

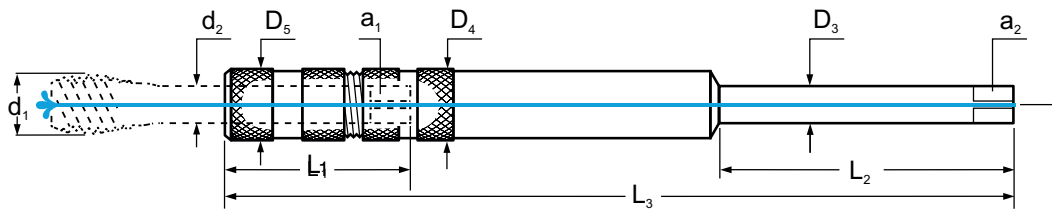

Short

Mark	d ₁		d ₂	D ₃	D ₄ =D ₅	L ₁	L ₂	L ₃	a ₁	a ₂	INDEX
	DIN-371	DIN-376									
PBNm 2,8/2,1-6/4,9-130	M2 - M2,6	M4	2,8	6	6,1	22	60	130	2,1	4,9	V0-211136-0206
PBNm 3,5/2,7-6/4,9-130	M3	M4,5 - M5	3,5	6	7,5	23	60	130	2,7	4,9	V0-211136-0306
PBNm 4,5/3,4-6/4,9-130	M4	M6	4,5	6	8,4	23	60	130	3,4	4,9	V0-211136-0406
PBNm 6/4,9-7/5,5-130	M4,5 - M6	M8	6	8	12,1	26	60	130	4,9	6,2	V0-211136-0607
PBNm 7/5,5-7/5,5-130	M7	M9 - M10	7	8	12,1	26	60	130	5,5	6,2	V0-211136-0707
PBNm 8/6,2-8/6,2-130	M8	M11	8	8	13	30	60	130	6,2	6,2	V0-211136-0808
PBNm 9/7-9/7-130	M9	M12	9	9	15	31	60	130	7	8	V0-211136-0909
PBNm 10/8-10/8-130	M10	-	10	10	15	33	60	130	8	8	V0-211136-1010
PBNm 11/9-11/9-130	-	M14	11	12	18	36	90	130	9	9	V0-211136-1111
PBNm 12/9-12/9-130	-	M16	12	12	18	36	90	130	9	9	V0-211136-1212
PBNm 14/11-14/11-200	-	M18	14	14	22	42	90	200	11	11	V0-211206-1414
PBNm 16/12-16/12-200	-	M20	16	16	22	42	90	200	12	12	V0-211206-1616
PBNm 18/14,5-18/14,5-200	-	M22/M24	18	18	26	43	100	200	14,5	14,5	V0-211206-1818
PBNm 20/16-20/16-200	-	M27	20	20	28	48	100	200	16	16	V0-211206-2020

Long

Mark	d ₁		d ₂	D ₃	D ₄ =D ₅	L ₁	L ₂	L ₃	a ₁	a ₂	INDEX
	DIN-371	DIN-376									
PBNm 6/4,9-7/5,5-230	M4,5 - M6	M8	6	8	12,1	26	70	230	4,9	6,2	V0-211236-0607
PBNm 7/5,5-7/5,5-230	M7	M9 - M10	7	8	12,1	26	70	230	5,5	6,2	V0-211236-0707
PBNm 8/6,2-8/6,2-230	M8	M11	8	8	13	30	80	230	6,2	6,2	V0-211236-0808
PBNm 9/7-9/7-230	M9	M12	9	10	15	31	80	230	7	8	V0-211236-0909
PBNm 10/8-10/8-230	M10	-	10	10	15	33	80	230	8	8	V0-211236-1010
PBNm 11/9-11/9-230	-	M14	11	12	18	36	90	230	9	9	V0-211236-1111
PBNm 12/9-12/9-230	-	M16	12	12	18	36	90	230	9	9	V0-211236-1212
PBNm 14/11-14/11-330	-	M18	14	14	22	42	100	330	11	11	V0-211336-1414
PBNm 16/12-16/12-330	-	M20	16	16	22	42	100	330	12	12	V0-211336-1616
PBNm 18/14,5-18/14,5-330	-	M22/M24	18	18	26	43	100	330	14,5	14,5	V0-211336-1818
PBNm 20/16-20/16-330	-	M27	20	20	28	48	100	330	16	16	V0-211336-2020

Screw pitch gauge

ISO Metric thread DIN-13

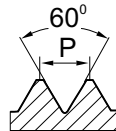

Whitworth thread BS-84:1956

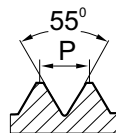

Mark	Pitch range	Amount of blades	INDEX
60°	0,4 ÷ 7 mm	20	V0-600000-0000
55°	62 ÷ 4 1"/P (TPI)	28	V0-550000-0000
55°/60°	62 ÷ 4 1"/P (TPI) 0,25 ÷ 7 mm	58	V0-556000-0000



MODEL	MPD-08/II	MPD-12/II	MPD-16/II	MPD-22/II	MPD-27/II
INDEX	P0-130000-10208	P0-130000-10312	P0-130000-10316	P0-130000-10322	P0-130000-10327
Tapping range	M2-M8	M3-M12	M3-M16	M3-M22	M3-M27
n [1/min]	700	400	300	120/300	70/220
Working area	Rmax=1900mm		Rmin=200mm		
Weight [kg]	23	23	27	39	39
Max. Torque [Nm]	12	32	52	100	160
Air flow rate [l/min]	840	840	840	935	935
Adapters in the delivery	FZS19/... M2,3,4,5,6,8	FZS19/... M4,5,6,8,10,12	FZS31/... M6,8,10,12,14,16	FZS31/... M6,8,10,12,16,20	FZS31/... M8,10,12,16,20,24
Adapters in option	-	FZS19/M3	FZS19/...M3,4,5 +FR31/19	FZS19/...M3,4,5 +FR-31/19; FZS31/...M14,18,22	FZS19/...M3,4,5 +FR-31/19; FZS31/...M6,14,18,22,27

Standard accessories

- spindle with pneumatic drive
- dual rigid arm
- mounting column
- air preparation system
- radial arm
- six adapters for taps



Full range of FZS adapters and FR reductions on p. 239 and 241

Tilting head for spindle mounting with adjustable angle in range 0-90°



MODEL	Weight	INDEX
MGO-08-90°	1,1 kg	P0-133000-00890
MGO-12-90°	1,1 kg	P0-133000-01290
MGO-16-90°	1,5 kg	P0-133000-01690
MGO-22-90°	1,5 kg	P0-133000-02290
MGO-27-90°	1,5 kg	P0-133000-02790

Magnetic base for machines



MODEL	Clamping force	Dimensions	Machine type	Weight	INDEX
MMP-300	300 kg	150x90x93	MPD-08,12,16	8,6 kg	P0-133000-00300
MMP-600	600 kg	224x115x120	MPD-22,27	21 kg	P0-133000-00600

Drill chuck adapters

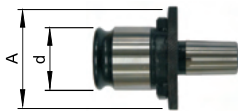

Drill chucks

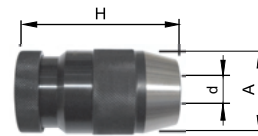

MODEL	d	Taper	A	INDEX	MODEL	Taper	A	H	d	INDEX
FZA19/JT2	19	JT2	30	R-FZA19/JT2	OW-JT2/D8	JT2	38	68	0-8	R-OW-JT2/D8
FZA19/JT6	19	JT6	30	R-FZA19/JT6	OW-JT6/D13	JT6	48	90	0-13	R-OW-JT6/D13
FZA31/JT6	31	JT6	48	R-FZA31/JT6						

Pneumatic hand tapping machines

MPP-12-1

with flexible head



MPP-12-3

with holder for FZS adapters



MODEL	M	n [1/min]	Taper	Air flow rate	Diameter of the pipe	Weight	Equipment	INDEX
MPP-12-1	M2-M12	250	B12	400 l/min	9,5 mm	2 kg	Handle	P0-136000-00121
MPP-12-3	M2-M12	250	B12	400 l/min	9,5 mm	1,5 kg	Handle + FZS19/...M3,4,5,6,8,10	P0-136000-00123

PMW-1300 $\varnothing 2\text{mm} \div \varnothing 13\text{mm}$
INDEX: PMW-1300
Dimensions: 305x172x180 (mm)

Drill diameter: $\varnothing 2 \div \varnothing 13$
Point angle: $85^\circ - 140^\circ$
Power: 220÷230 V 50Hz
Motor: 90 W
Revolutions per minute: 6000 rpm/min
Weight: 10 kg
Diamond wheel: B200
Collets: ER-20

Set accessories:

Collets ER20 $\varnothing 2,5 \div \varnothing 13$ - 12 pcs., Diamond wheel B200 - 1 pcs., Allen key - 4mm i 6mm after 1 pcs.

PMW-2000 $\varnothing 3\text{mm} \div \varnothing 20\text{mm}$
INDEX: PMW-2000
Dimensions: 480x260x240 (mm)

Drill diameter: $\varnothing 3 \div \varnothing 20$
Point angle: $85^\circ - 140^\circ$
Power: 220÷230 V 50Hz
Motor: 450 W
Revolutions per minute: 4300 rpm/min
Weight: 21 kg
Diamond wheel: CBN200
Collets: ER-25

Set accessories:

Collets ER25 $\varnothing 3 \div \varnothing 20$ - 18 pcs., Diamond wheel CBN200 - 1 pcs., Allen key - 4mm i 6mm after 1 pcs.

PMW-3000 $\varnothing 12\text{mm} \div \varnothing 26\text{mm}$
INDEX: PMW-3000
Dimensions: 470x260x235 (mm)



Drill diameter: $\varnothing 12 \div \varnothing 26$, optional $\varnothing 8 \div \varnothing 30$
Point angle: $85^\circ - 140^\circ$
Power: 220÷230 V 50Hz
Motor: 450 W
Revolutions per minute: 4300 rpm/min
Weight: 25 kg
Diamond wheel: B150
Collets: ER-40

Set accessories:

Collets ER40 $\varnothing 12 \div \varnothing 26$ - 15 pcs., Diamond wheel B150 - 1 pcs., Allen key - 4mm i 6mm after 1 pcs.

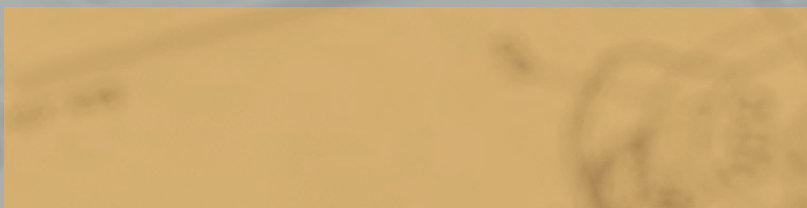

TECHNICAL
INFORMATION





































CATALOGUE PAGES

277 - 346

1. Thread type	277 - 278
2. Materials used for production of tools	279
3. PVD coatings used for tools	280 - 282
4. Taps	283 - 295
5. Forming taps	296 - 299
6. Dies	300 - 302
7. Gauges	303 - 307
8. Twist drills	308 - 310
9. Tap holders	311 - 317
10. End mills	318 - 328
11. Information table	329 - 340
12. Form of tool selection	341 - 346

1. THREAD TYPE

M		Metric thread ISO DIN-13
MF		Metric fine thread ISO DIN-13 (symbol used only in catalogues for distinguish from metric coarse thread)
UNC		American unified coarse thread ANSI B-1.1
UNF		American unified fine thread ANSI B-1.1
UNEF		American unified extra fine thread ANSI B-1.1
UNJC		American unified coarse thread for aerospace industry UNJC ASME B1.15
UNJF		American unified fine thread for aerospace industry UNJF ASME B1.15
G		Whitworth pipe thread DIN-ISO 228 (identical with BSP)
Rp		Whitworth internal cylindrical pipe thread PN-ISO 7/1 and DIN EN 10226-1 (identical with BSPP)
Rc		Whitworth internal tapered pipe thread PN-ISO 7/1, DIN EN 10226-2 (identical with BSPT)
NPT		American tapered pipe thread with dryseal material ANSI B-1.20.1
NPTF		American tapered pipe thread without dryseal material ANSI B 1.20.4
NPSF		American cylindrical pipe thread ANSI B 1.20.3
BSW		Whitworth thread BS-84:1956 (in the past - W)
BSF		Whitworth fine thread BS-84:2007
EG M		Metric thread for thread inserts V-Coil
EG UNC		Metric thread for thread inserts V-Coil
EG UNF		Metric thread for thread inserts V-Coil
Pg		Steel conduit thread DIN-40430 (P)
Tr		Trapezoidal symmetric thread DIN-103

R		Whitworth external tapered pipe thread ISO-7/1 (identical with BSPT)
Rd		Cylindrical round thread PN-84/M-02035 and DIN 405
FG		Bicycle thread DIN 79012
BSC		Bicycle thread BS 811
Ven		Valve thread PN-ISO 4570
Vg		Valve thread DIN 7756
E		Edison electrical thread IEC 60061
UN		American unified thread ANSI B-1.1 (with preferential pitches: 4, 6, 8, 12, 16, 20, 28, 32 of threads per inch)
UNS		American unified special thread ANSI B-1.1
Whit. S		Special Whitworth thread BS 84
S		Trapezoidal non-symmetric thread
Wzyl		Cylindrical Whitworth thread for gas cylinder valves DIN 477
Wkeg		Tapered Whitworth thread for gas cylinder valves PN-82/M-69223 and DIN 477
NPSM (NPS)		American cylindrical pipe thread ANSI B 1.20.1

2. MATERIALS USED FOR PRODUCTION OF TOOLS

Symbol	Name	Description
HSS	High-speed steel	Standard material for general purpose cutting tools
HSSE (HSCo5)	High-speed steel	Material with high heat resistance, cobalt content allows to increase the hardening temperature and improves the stability of cutting edges.
HSSE-PM	High-speed powder steel	This homogeneously structured material for tools, obtained with the use of powder metallurgy, has the high-hardness and high-temperature resistance properties, which ensure that the tools made with it are characterized by high stability of cutting edges.
VHM	Micrograin cemented carbide	The homogeneously structured material for tools, obtained with the use of powder metallurgy from the tungsten carbide, features high abrasion resistance and hardness. In comparison with the high-speed steel it is more brittle and usually used with the PVD coatings

3. PVD COATINGS USED FOR TOOLS

HL COATING

Coating	TiAlN + WC/C
Structure	Multilayer nanocomposite
Hardness	3000 HV _{0,05}
Max. working temp.	800°C
Coefficient of friction	0,15
Color of coating	Dark Grey 

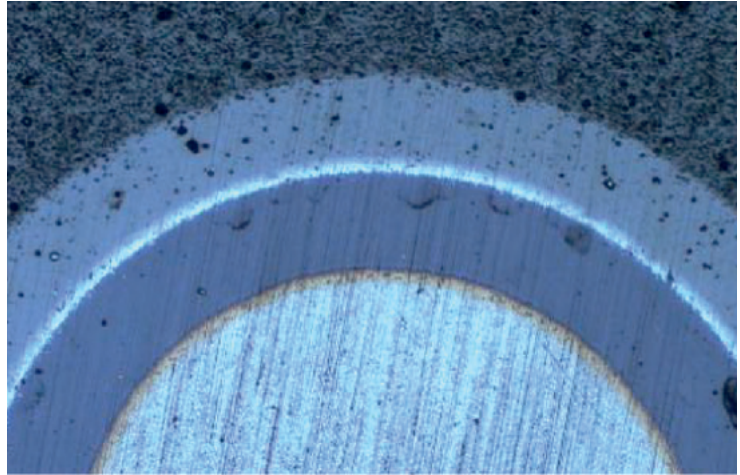

High performance properties of the HL coating have been achieved by application of the advanced nanocomposite structure. TiAlN layer, with its high hardness and temperature resistance, provides a stable, resistant to abrasion base of the coating. The top WC/C layer consists of tungsten carbide nanocrystallites surrounded by a carbon ply features excellent tribological properties. Hard WC separations provide abrasion resistance, while maintaining excellent the sliding properties of carbon. By combining advantages of two layers, the HL coating is ideal for processing of a wide variety of materials, it improves chips evacuation, reduces cutting forces and protects cutting edges from the impact of high temperatures. The HL-coated tools can work with the minimum quantity of lubrication (MQL). The coating is designed for processing materials from the Groups P, M, K, N, S.

TS COATING

Coating	TiAlN + TiAlSiN
Structure	Nanocomposite
Hardness	3800 HV _{0,05}
Max. working temp	1100°C
Coefficient of friction	0,15
Color of coating	Coppery 

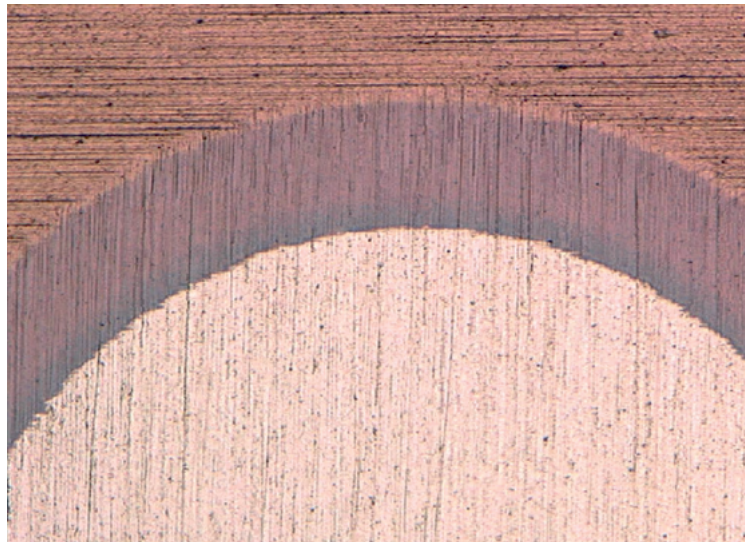

Due to silicon content in TiAlN coating, TS has multilayer nanocomposite structure. TS is being produced in the newest HiPIMS technology which ensures mechanical properties unreachable for other methods. Coatings produced in HiPIMS technology are characterized by the highest cracking resistant. Composition and coating technology causes that new TS coating works very well both in traditional materials from P, K ISO groups and in difficult to machine M, S groups.

PVD COATINGS USED FOR TOOLS

TN2 COATING

Coating	TiAlN + TiN
Structure	Double-layer nanostructure
Hardness	3500 HV _{0,05}
Max. working temp	800°C
Coefficient of friction	0,3
Color of coating	Gold 

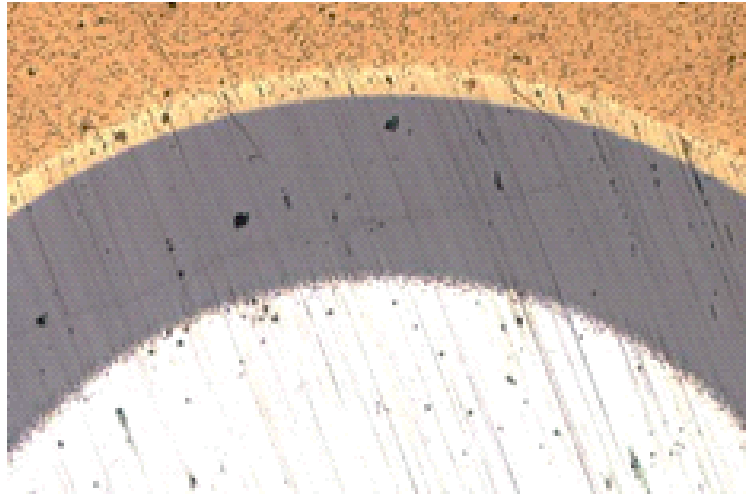

The double-layer coating TN2, manufactured with a dropleless method and treated with the surface fine finish processes, features very good resistance to abrasion, high thermal resistance and low coefficient of friction. Due to reduction of friction, the tool's life is considerably longer, and the quality of the surface processed by the tool is improved. By combining the extremely hard TiAlN layer with the malleable TiN layer, we have obtained a smart, self-adjusting structure of the tool's surface, which accommodates itself to the processing related stresses, thus improving the tool's resistance to breaks. Tn2 is intended, in particular, for the tools for processing of the Group P materials (for Rm < 1000 MPa), and the materials from Groups M, K, N.

TC COATING

Coating	TiN + TiCN
Structure	Multilayer
Hardness	3700 HV _{0,05}
Max. working temp	400°C
Coefficient of friction	0,2
Color of coating	Anthracite 



TC is a multilayer, general purpose coating. It features a very high hardness, good durability and low coefficient of friction. The basic TiN layer provides high adhesion to a tool and considerable resistance to dynamic loads. The top TiCN/TiC layer, with its high hardness and low coefficient of friction, ensures a very good resistance to abrasion. Combination of the above properties allows for protection of the edges from the processed material buildup, and from chipping. Due to the relatively low temperature resistance, proper cooling of the tool should be applied. The coating is intended mainly for the tools for processing of materials from the Groups P (in particular of high strength Rm > 1000 MPa) K, N, H.

PVD COATINGS USED FOR TOOLS

AT COATING

Coating	AlTiN
Structure	Gradient
Hardness	3700 HV _{0,05}
Max. working temp.	900°C
Coefficient of friction	0,3
Color of coating	Purplish-Grey 

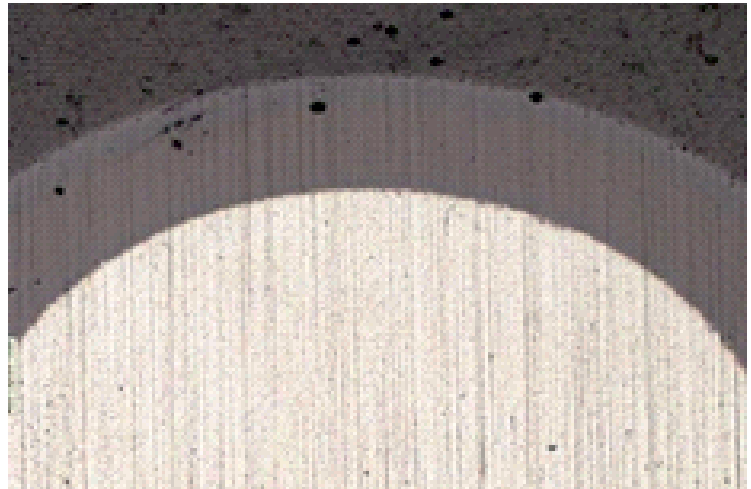

The AT Coating, with the increased Aluminum (Al) content, features high hardness and temperature resistance. The released from the coating, during processing, aluminum oxides serve as additional lubrication of a tool, and at the same time they create a thermal barrier, preventing the coating from being worn out, even in the most extreme conditions. Chemical composition and the nanogradient structure ensure high hardness of the coating. As a result, the high resistance to abrasion is achieved, which directly translates into the tool's longer life. The coating may be used for tools exposed to high temperatures, and is suitable for work both, with coolant and without it. The coating is designed for processing materials from the Groups P, M, K, N, S.

TiB₂ COATING

Coating	TiB ₂
Structure	Monolayer
Hardness	4000 HV _{0,05}
Max. working temp.	900°C
Color of coating	Silver 

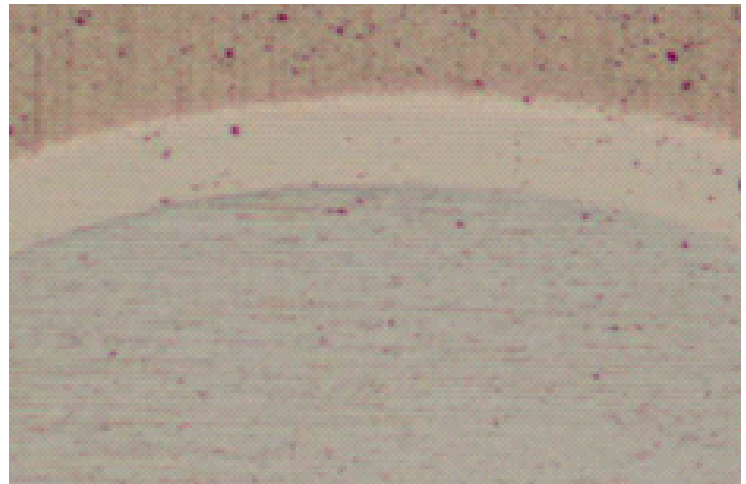

The material of coating, the TB (titanium diboride), is a ceramic material with outstanding properties with regard to its hardness and resistance to abrasion. With its carefully prepared composition (no affinity with aluminum), the material provides high chemical stability and prevents the processed material buildup on cutting edges. The dropletless method of manufacturing the coating allows to obtain a very smooth finish, which in turn translates into a very good quality the workpieces' surfaces. The coating is designed for processing materials from the Group N, mainly aluminum alloys (Si<12%) and unalloyed titanium.

4. TAPS

4.1. Tap construction elements (on example of DIN-371)

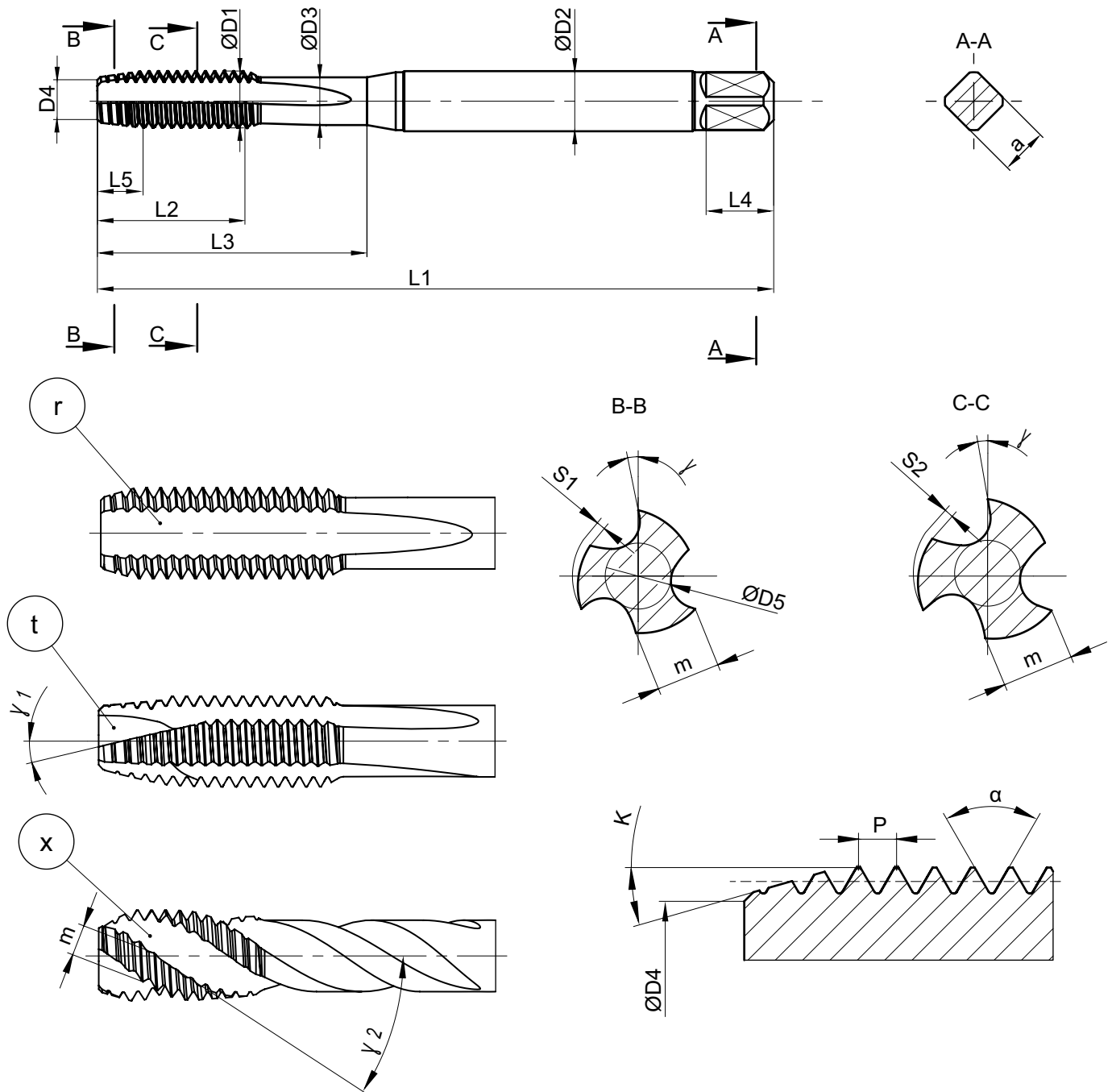

L1 - total length
 L2 - thread length
 L3 - useful length
 L4 - length of driving square
 L5 - chamfer length
 a - size of square
 ØD1 - thread diameter
 ØD2 - shank diameter
 ØD3 - neck diameter
 ØD4 - (chamfer) point diameter
 ØD5 - web (core) diameter
 m - width of land

S1 - relief of chamfer
 S2 - relief of thread
 P - pitch of thread
 α - angle of thread
 γ - rake angle
 γ_1 - spiral point angle
 γ_2 - angle of spiral flutes
 κ - chamfer angle
 r - straight flute
 x - spiral flute
 t - spiral point
 z - number of lands

4.2. Dimension standards

Dimension standards assign proper taps outer dimensions (total length, thread length, shank diameter and size of square) of nominal threads dimensions.

Symbols	Description
DIN-371	Machine taps with reinforced shank for metric coarse and fine threads M3 ÷ M10 and for the threads UNC, UNF, BSW, BSF within the range of nominal diameters 1/8" ÷ 3/8"
DIN-376	Machine taps with reduced shank diameter for metric coarse threads and for the threads UNC and BSW
DIN-374	Machine taps with reduced shank diameter for metric fine threads and for the threads UNF i BSF
DIN-5156	Machine taps with reduced shank diameter for the threads G, Rp and Rc
DIN-352	Short hand taps for metric coarse threads Norm is also suitable for UNC and BSW threads
DIN-2181	Short hand taps for metric fine threads Norm is also suitable for UNF and BSF threads
DIN-5157	Short hand taps and machine taps for pipe threads G, Rp

4.2. Groups of Tools by Applications

<p>MASTERTAP</p> <p>P M K N S</p>	<p>Group of machine taps intended for high performance thread cutting in a wide range of materials, such as steel, stainless steel, cast iron, non-ferrous metals and heat-resistant alloys, and titanium alloys.</p> <p>The thread cutting may be carried out in modern, highly efficient machining centers with high cutting speeds, on the older types of CNC machines, and on the conventional machines with slightly lower processing parameters.</p>
<p>800X</p> <p>P M K N</p>	<p>Innovative variety of machine tap 800, designed also for processing of stainless steel. The innovative manufacturing technologies may even double durability and processing performance we had so far.</p> <p>All these features make the 800X tap the best choice for small and medium size production series, while still offering favorable price to quality ratio.</p>
<p>800</p> <p>P K N</p>	<p>For structural, free machining and low alloy steels with the tensile strength of $600 \text{ MPa} \leq R_m \leq 800 \text{ Mpa}$</p>
<p>FAN-1200</p> <p>P</p>	<p>For tool and difficult to process steels with the tensile strength of $800 \text{ MPa} \leq R_m \leq 1200 \text{ MPa}$, and for heat treated steels up to 38 HRC</p>
<p>1400-HT</p> <p>P M K N</p>	<p>For machining hard and abrasive materials such as steel with a tensile strength from 1200 to 1400 MPa and aluminium with high silicon content.</p>
<p>INOX</p> <p>P M</p>	<p>For high alloy steel, stainless and acid resistant steels with a tensile strength of $R_m \leq 1000 \text{ MPa}$</p>
<p>GG</p> <p>K</p>	<p>For processing of grey and nodular cast iron</p>
<p>GAL</p> <p>N</p>	<p>For cast aluminum alloys with the Si content of max. 12%</p>
<p>HRC</p> <p>H</p>	<p>For materials, which have been hardened. The number next to the symbol indicates the maximum hardness of the material to be processed, in the HRC scale</p>
<p>S-NC</p> <p>P M K N S</p>	<p>For synchronized tapping on CNC machines with the "rigid tapping" function for a wide range of materials with the high cutting speeds</p>
<p>Ms</p> <p>N</p>	<p>For brass and short chip bronze</p>

4.3. Types of machine tap chamfers

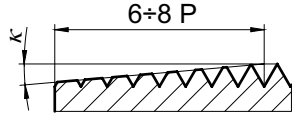
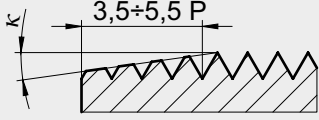
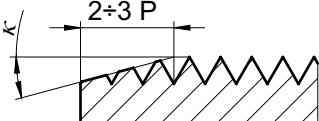
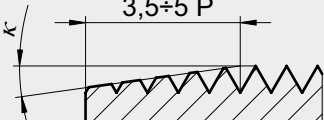
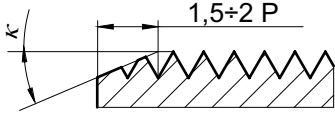
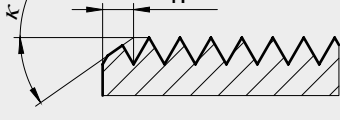
Symbol	Sketch	Chamfer length presented in the quantity of the thread coils	Angle
A		$6 \div 8 P$	5°
B		$3,5 \div 5,5 P$	8°
C		$2 \div 3 P$	17°
D		$3,5 \div 5 P$	8°
E		$1,5 \div 2 P$	23°
F		$1 P$	35°

4.4. Types of Machine Tap Chip Flutes

Straight Flutes

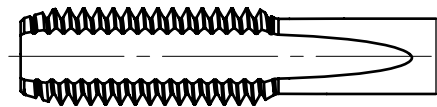

In combination with the chamfer A or D applied for the through holes and with the chamfer E or F for the blind holes. Tap with the chamfer C can be used for both types of holes.

It is recommended for materials giving a short chip. The grooves evacuate only some of the chips, which slowly move along the axis. The tap should not be used for deep blind holes or materials giving a long chip. The length of threads, which can be made - up to ca $1.5 \times D$

Straight Flutes with Spiral Point

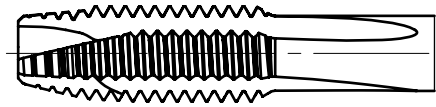

Designed for through holes, with thread along the full length of the hole.

Used together with the chamfer B, it is recommended for materials giving a long chip. The spiral point moves tightly squashed chips in the direction of feed, and prevents the grooves from clogging. Coolant reaches the working zone freely. The length of threads, which can be made - up to ca 3xD.

Spiral flutes

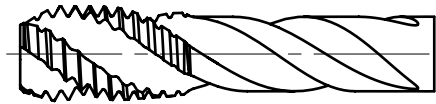

Together with the chamfer C and E used for the blind holes.

It is recommended for materials giving a long chip. Spiral flutes provide good chip evacuation in the direction from the hole toward the shank. Depending on the hole diameter, it is possible to make threads of up to 2,5xD.

Machine tap with spiral flutes should not be used for the through holes.

4.6. Types of the high performance machine tap center holes, depending on the diameter of the thread, chamfer and the applied standards

Working Part		Shank	
Solid cone	①		⑤ Phase
Stepped cone	②		
Chamfer E (without center hole)	③		
Internal center hole	④		⑥ Internal center hole

	External thread diameter (mm)	Type of center hole on cutting segment side			Type of center hole on shank side
		Chamfers A, C, D,	Chamfer B	Chamfer E, F	
DIN-371	≤7,2	①	①	③	⑤
	7,2≤8,2	②	①	③	⑤
	8,2<10,2	②	②	③	⑤
DIN-374 DIN-376 DIN-5156	≤7,2	①	①	③	⑤
	>7,2	④	④	④	⑥

Length of full solid cones for selected types of thread (Length of stepped cone $L_{nak}=1.8$ mm)

M		MF	
M1	0,6	M2,5 x 0,35	1,9
M1,2	0,8	M2,6 x 0,35	1,9
M1,4	1,0	M3 x 0,35	1,3
M1,6	1,1	M 3,5 x 0,35	1,6
M1,7	1,1	M4 x 0,5	1,8
M1,8	1,3	M5 x 0,5	2,3
M2	1,4	M6 x 0,75	2,6
M2,5	1,8	M7 x ,75	3,1
M2,6	1,8		
M3	1,3		
M3,5	1,5		
M4	1,7		
M4,5	1,9		
M5	2,1		
M6	2,5		
M7	3,0		
UNC		UNF	
No 4-40	2,0	No 4-48	2,1
No 5-40	1,3	No 5-44	1,4
No 6-32	1,4	No 6-40	1,5
No 8-32	1,8	No 8-36	1,8
No 10-24	2,0	No 10-32	2,1
No 12-24	2,3	No 12-28	2,3
1/4-20	2,6	1/4 - 28	2,8
5/16-18	3,3	5/16 - 24	3,5
BSW		BSF	
1/8 - 40	1,25	1/4 - 26	2,65
3/16 - 24	1,8	5/16 - 22	3,4
1/4 - 20	2,55		
5/16 - 18	3,25		

4.7. Application of Tools with Internal Channels for Supplying a Coolant IK/IKR

IK - Central cooling channel is recommended for the blind holes, facilitates chip evacuation of chips toward the shank, improves lubrication and cooling conditions, extends tool life



IKR - Central cooling channel divided into several radial channels, which supply coolant into each of the chip flutes separately. The solution is recommended for tapping of the through holes, facilitates evacuation of chips in the direction of feed, improve lubrication and cooling conditions, extends tool life.



4.8. Classes of Machine Taps

The machine taps presented in our catalog are made in the basic class, intended for the most commonly used internal thread tolerances, appropriate for the particular thread types: for metric thread 6H, for unified thread UNC, UNF - 2B, for Whitworth thread BSW, BSF - "normal." Per individual request we can manufacture the taps in other classes. Tap classes (ie. the tolerance field of a working segment) for metric threads are unified by international and national standards. A particular class of the tap threads allow for two or three fields of tolerance (see drawing and table below.)

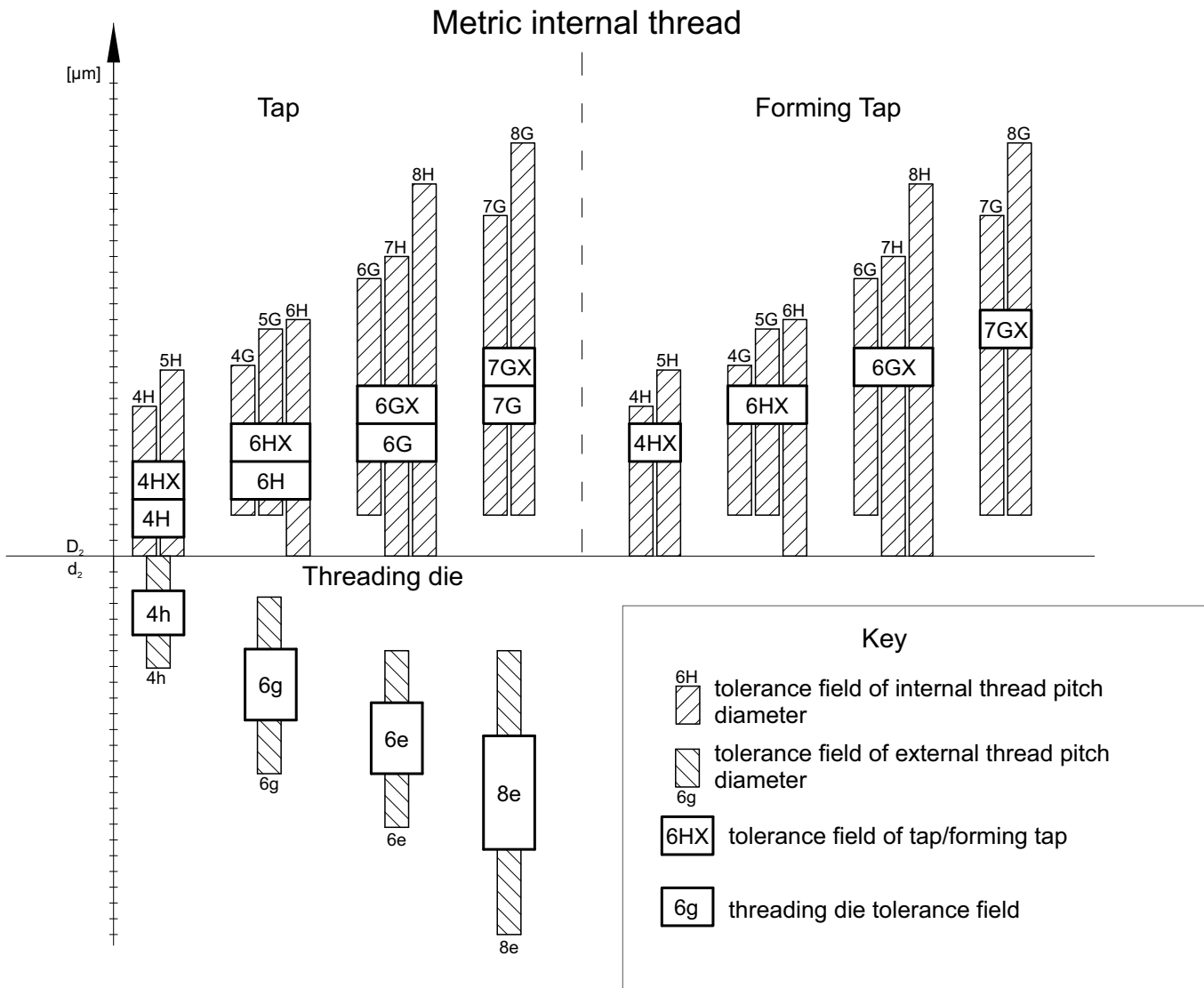

According to DIN 802	Tolerance field of internal thread				
4H	4H	5H	-	-	-
6H	4G	5G	6H	-	-
6G	-	-	6G	7H	8H
7G*	-	-	-	7G	8G

*DIN 802 provides the possibility of correction the tap tolerance comparing to the standard demands in case when it is required by the particular machining conditions, e.g. the sort of machining material. In such situation the symbol of the tap's class with the sign "X", e.g. 6HX, 6GX is obligatory.

Marking

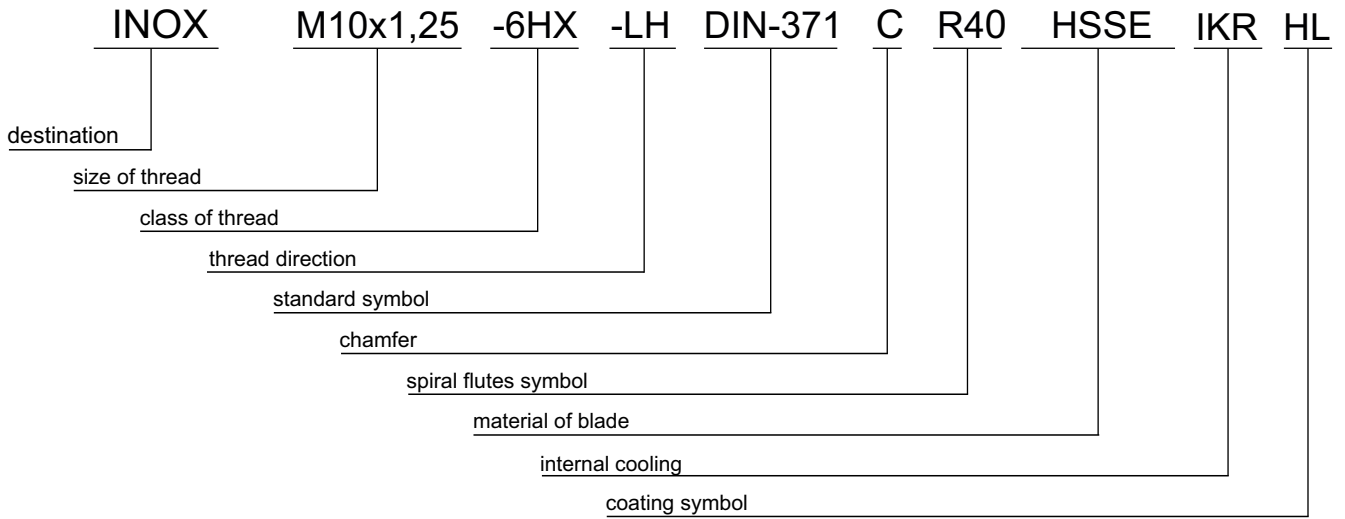

Stamping

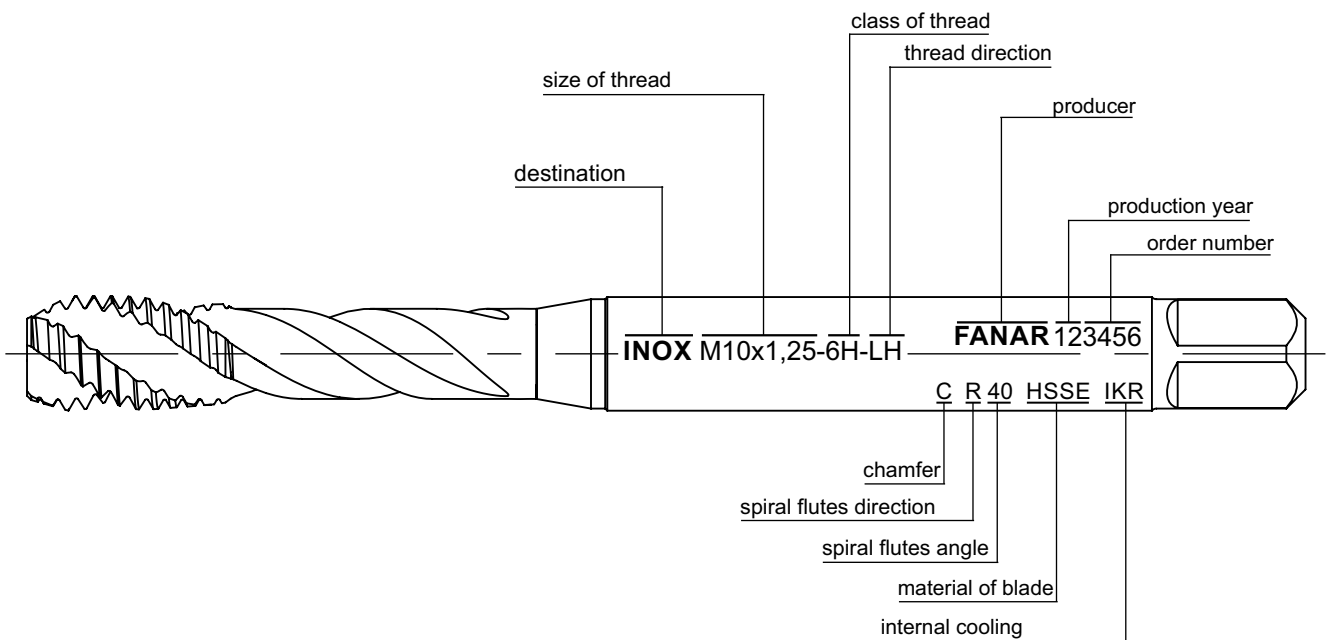

4.10. Recommendations for Processing with Machine Taps

Tapping is usually one of the last operations in the process of machining a workpiece. An error occurring in the process of tapping may result in additional costs associated not only with the damaged tap, but often with the workpiece material, as well as with the machining processes preceding the tapping. In order to avoid such problems, we encourage you to read and apply the below recommendations regarding the tapping process.

4.11. Threading process

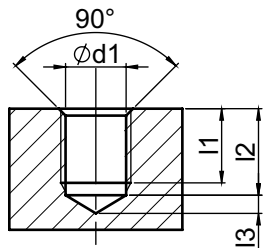
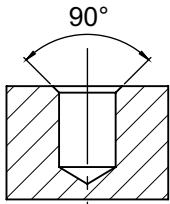
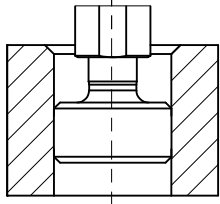
Operation		Recommendations
10	Drilling  $\varnothing d1$ - recommended diameter for tapping 11 - depth of thread 12 - depth of tapping hole 13 - length of point	<ul style="list-style-type: none"> - The diameter of the drill (see chapter 6, page 141) should be consistent with the recommended value, presented on the catalog page of a tool being used. - In the case of materials with $R_m > 1200$ MPa, the hole diameter should be possibly close to the upper limit of its tolerance. - In the case of a blind hole, to achieve the required usable length of a thread, the depth of the drilled hole should take into account the length of the point of the drill, length of the tap's cone (Table on page 231) and the chamfer.
20	Chamfering of the Hole's Edge 	<ul style="list-style-type: none"> - In order to facilitate insertion of the tap into the hole and to reduce resistance in the beginning of its work, the edges of the drilled hole should be chamfered with a deburring tool with the tip angle of 90° (Section 6, page 152)
30	Validation of the tapping hole 	<ul style="list-style-type: none"> - When notching thread with a tap, the minor diameter depends on the diameter of the drilled hole. Correctness of the drilled holes should be checked with a smooth gauge for tapping holes (Section 7, page 162), according to the recommendations included in the technical section referring to gauges

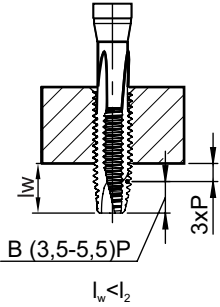
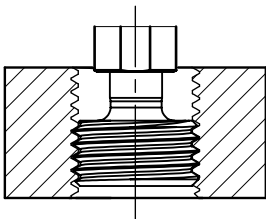
Operation		Recommendations
40	Tapping	<ul style="list-style-type: none"> - When tapping the through holes using a tap with the spiral point, special attention must be paid when removing the tap from the hole. For the proper thread cut and the chip evacuation, the removal of the tap from the tap hole should include the entire length of the spiral point + ca 3 thread pitches.
		<ul style="list-style-type: none"> - When tapping blind holes, there should be no collision between the tap face and the bottom of the hole. - In the case of the numerically controlled machines with synchronous tapping cycle, it is recommended to use the tap grip with the minimal axial compensation. - Applied machining speeds should take into account how the workpiece and the tap have been fixed, type of the processed material, type and condition of the machine, and conditions of the tap lubrication.
50	Validation of the Thread	<ul style="list-style-type: none"> - Upon completion of tapping, it should be checked with a tapping gauge (Section 7, page 221), in accordance with the recommendations included in the technical section referring to gauges.
		

4.11. Troubleshooting guide for tapping

Problem: Tapping oversized threads (no-go gauge is too loose)	
You used improper tap for material and thread application.	You should use a suitable tap hole type and material being cutted according to the table in catalogue.
Cutting speed was too high.	You should reduce cutting speed. You should use more coolant/lubrication.
There was cold welding on the flanks of the tap.	You should change your tool for new one. You should use coated tap. You should use more coolant/lubrication. You should remove damaged teeth.
Chip packing in flutes occurred.	You should use tap with another flute geometry. There could be necessity of using set of taps.
Grinding burr occurred.	Remove it with fiber brush.
Incorrect fixturing or positioning of part	You should use tap holders with axial and parallel compensation. Try precisely fix cutted element.
Inconsistent feed of tap.	You should control the feed while tapping. You should check parameters of CNC machine (program) Check lead screw for backlash. You should use holder with compensation.
Problem: Tapping oversized threads (nogo gauge is loose)	
The tolerance of used tap was too high comparing with required class of the thread.	You should check marking on the tap and revise if it is suitable for making required class of thread. If you have any problems contact our Technical Representative.
Inappropriate reconditioning of a tap..	While reconditioning it is required that all ground surfaces maintain the original geometry put on by the manufacturer. For instructive information please contact our Representative.
Problem: Tapping undersized threads (go gauge doesn't enter part way into hole).	
The chosen tap has not suitable geometry for multiple regrinds.	You should limit the number of tap regrinds. Try to use another tap.
A part of tap surface wasn't renewed while resharping.	Try to grind the tap again. You should use a new tap.
You used inappropriate tap for the tread being made and material being cutted.	You should use tap suitable for the hole type and material being cutted according to the table from catalogue.
The used tap has too small nominal size (tolerance).	You should check marking on the tap and revise if it is suitable for making required class of thread. If you have any problems contact our Technical Representative.
Problem: Tapping bellmouthed hole (first few threads are oversized)	
The tolerance of used tap was too high comparing with required class of the thread.	You should check marking on the tap and revise if it is suitable for making required class of thread. If you have any problems contact our Technical Representative.
Inappropriate reconditioning of a tap.	While reconditioning it is required that all ground surfaces maintain the original geometry put on by the manufacturer. For instructive information please contact our Representative.
Problem: Too low tap life	
All reasons stated in next table "torn and rough threads".	Please read the table "torn and rough threads"
The tap lost its hardness by excess heat during regrinding.	You should change the specification of the grinding wheel. You should use coolant while grinding.
The loss of surface treatment occurred after regrinding.	Retreat surface of tap. You should check suitability of surface treatment for material being tapped.
Work hardened drill hole and hole chamfer.	You should frequently change or regrind tap drill. You should check proper drilling speed and feed. Please anneal part before tapping.

Problem: Damage of cutting part	
You used improper tap for material and thread application.	You should use tap suitable for the hole type and material being cutted according to the table from catalogue.
Tap drill was too small.	You should use correct size of drill. Please check recommended size drill in catalogue (note that there are different sizes for taps and for forming taps). If you have any problems contact our Technical Representative.
The tap hole wasn't deep enough.	You should check the actual drill depth (the drill could have slipped back into holder).
Tap drill hole was missing.	Please make sure that the tap drill hole is present (that's common problem in multiple spindle applications on transfer lines).
Chips packing in flutes occurred.	Try to use tap with different flute geometry (angle). There could be necessity of using set of taps.
Cold welding on the flanks of the tap (loading).	You should use a new tap. You should use coated tap. You should use more coolant/lubrication. You should remove damaged teeth.
Overload of the chamfer teeth occurred.	Use tap with longer chamfer. You should use tap with increased number of flutes to provide more chamfered teeth.
Inorrect fixturing or positioning of part.	You should use tap holders with axial and parallel compensation. Try presicely fix cutted element.
The tap was hitting the bottom of the hole.	You should use tap holders with length compensation and with torque overload system.
Tapping hard or high tensile materials.	You should check if yor tap is properly selected. High performance taps HSSE-PM and VHM may be more suitable than HSSE taps.
Problem: Torn and rough threads	
You used improper tap for material and thread application.	You should use tap suitable for the hole type and material being cutted according to the table from catalogue.
Cutting speed was too fast or too slow.	Please select proper cutting speed. Improve coolant selection to assist the effects of tap speed.
There was cold welding on the flanks of the tap.	You should use a new tap. You should use coated tap. You should use more coolant/lubrication. You should remove damaged teeth.
Chip packing in flutes occurred.	Try to use tap with different flute geometry (angle). There could be necessity of using set of taps.
Grinding burr occurred.	Remove it with fiber brush.
Tap drill was too small.	You should use correct size of drill. Please check recommended size drill in catalogue (note that there are different sizes for taps and for forming taps). If you have any problems contact our Technical Representative.
There wasn't proper cooling or lubrication while tapping.	Select properly lubricant according to the notes from the catalogue. Use adequate amounts of coolant/lubrication.
Tool overloading occurred due to coarse pitch, hard materials or short chamfers.	There could be necessity of using set of taps.

4.12. Regeneration - rake angle information

Material group	Material	Designation	γ_p [°]
P	Steel	800	10 – 13
		FAN-1200	7 – 10
		1400	5 – 7
M	Stainless steel	INOX	10 – 13
K	Cast iron	GG	4 – 6
N	Non-ferrous materials	GAL	7 – 9
			10 – 13
			4 – 6
S	heat-resistant alloys, titanium alloys	1400	5 – 7
H	Hard materials	HRC50	-5 – -4

5. FORMING TAPS

5.1. Forming tap construction elements

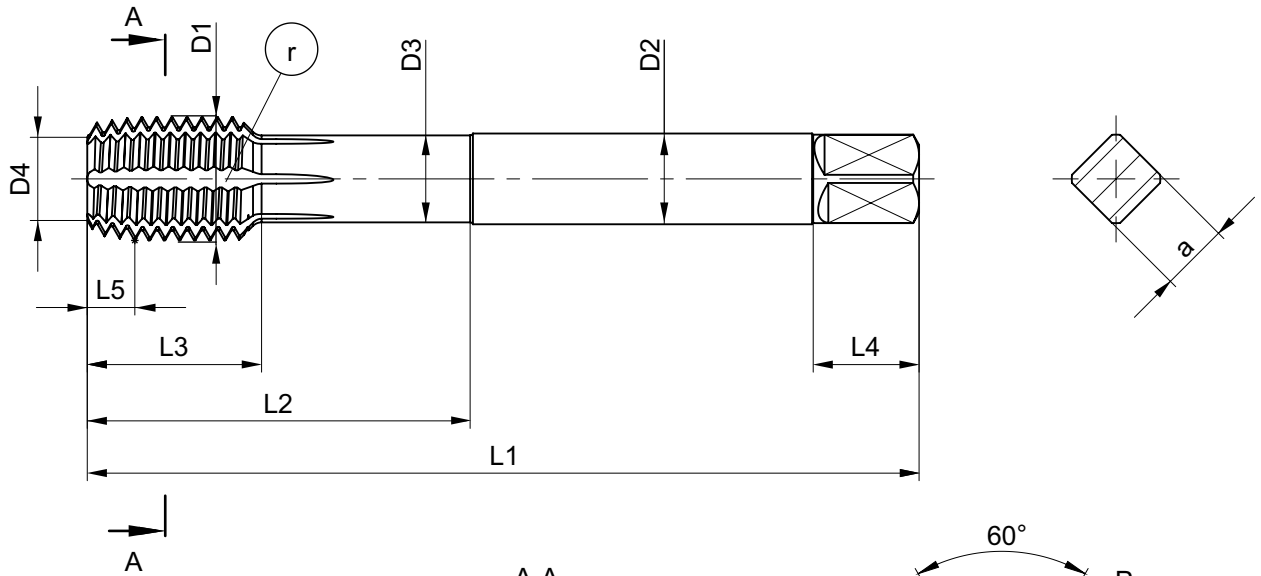

- L1- total length
- L2 - thread length
- L3 - useful length
- L4 - length of driving square
- L5 - chamfer length
- \varnothing D1 - thread diameter
- \varnothing D2 - shank diameter
- \varnothing D3 - neck diameter
- \varnothing D4 - (chamfer) point diameter
- \varnothing D5 - web (core) diameter

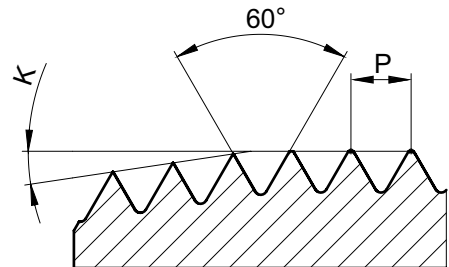
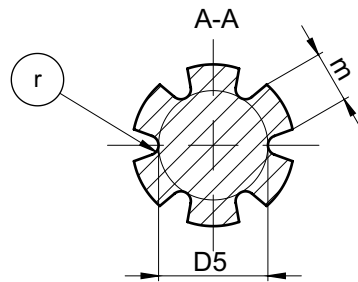

- r - straight flute
- κ - chamfer angle
- α - angle of thread
- P - pitch of thread
- m - width of land
- a - size of square

5.2. Types of forming tap chamfers

Symbol	Sketch	Chamfer length presented in the quantity of the thread coils	Angle
C		$2 \div 3 P$	$8,5^\circ$
E		$1,5 \div 2 P$	$11,5^\circ$

5.3. Marking and stamping of forming taps

Marking

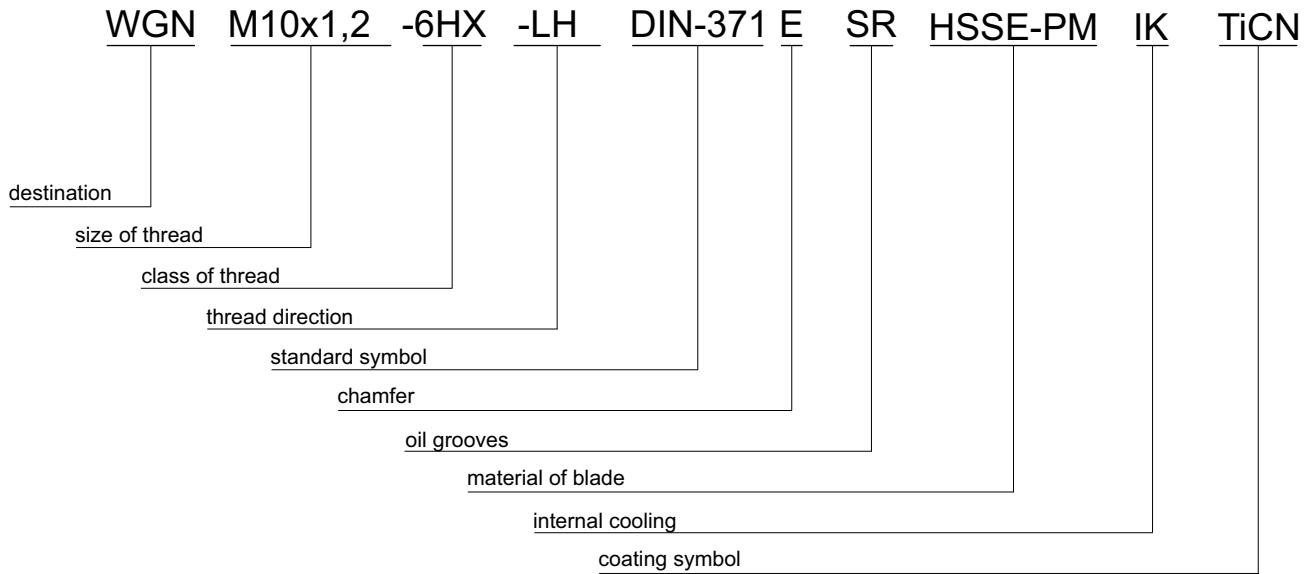

Stamping

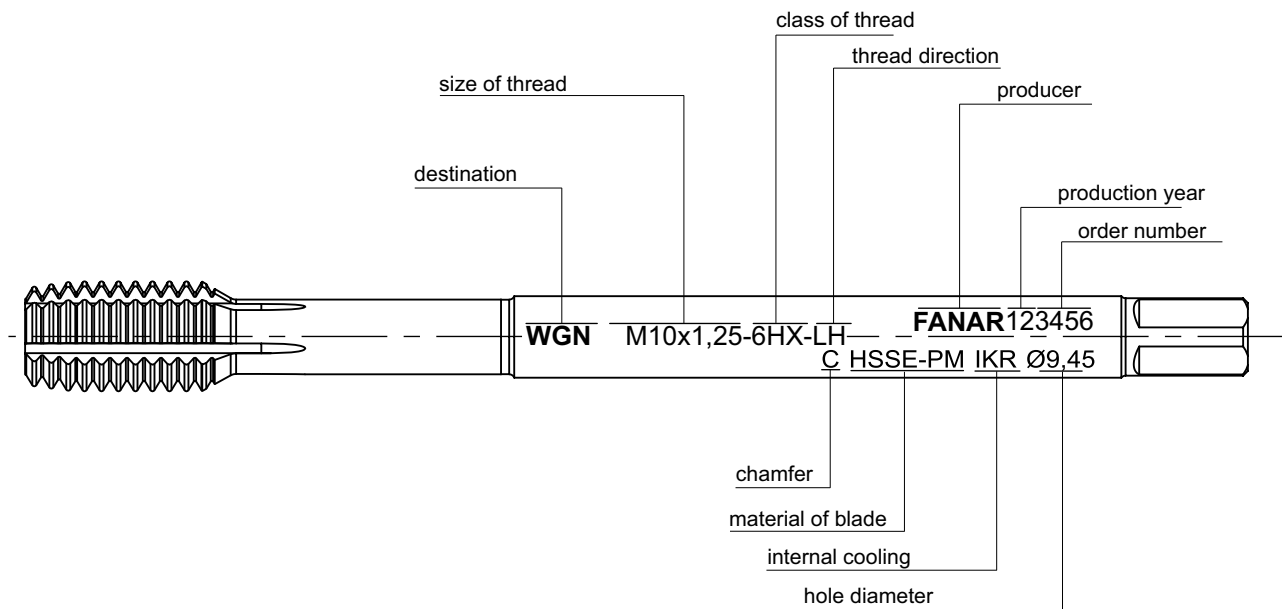

5.4. Difference Between Cut and Formed Thread

Cold forming is a chip free method of processing, where the workpiece material is being imprinted, the thread is being formed by plastic deformation, without the need for the material evacuation. The material formed is cold, and its fibers are not being broken.

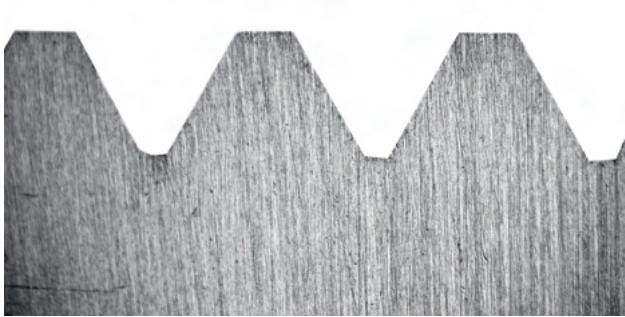

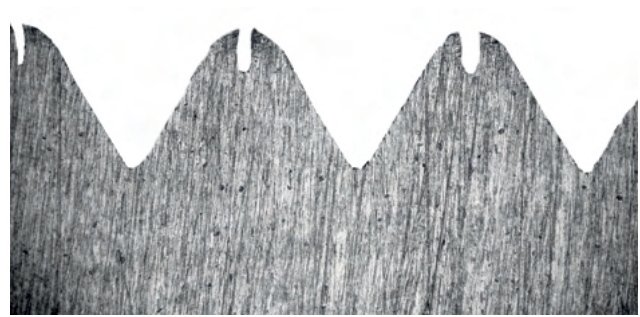

Cut Thread



Cold formed Thread

Advantages of Forming threads	Disadvantages of Forming threads
<ul style="list-style-type: none"> → chip free processing → one tool for both, through and blind holes → possibility to tap deep holes 4xD → high durability of thread, especially on side surfaces of a thread pitch → smoother thread surface → no errors in pitch or form of thread → the ability to tap with significantly higher processing parameters, because the processing performance of most materials increases with speed, it has no negative impact on the tool life → high rigidity of the tool reduces risk of its damage 	<ul style="list-style-type: none"> → much greater forming torques in comparison to cutting → incomplete formation of a thread top → thread load carrying capacity amounts to about 80% of the load carrying capacity of the cut thread, but its strength is much greater → application range limited to plastic materials → greater tolerance in the process of threading → method not recommended for food and pharmaceutical industry

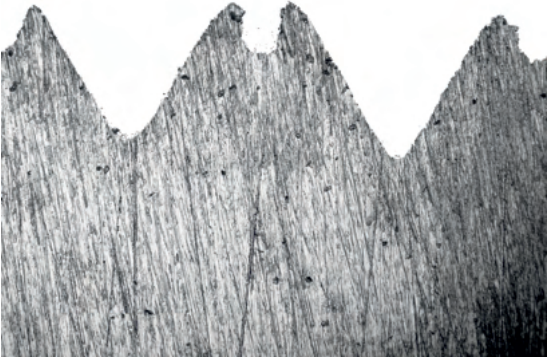
5.5. Thread forming Troubleshooting

Problem	Solution
<p data-bbox="172 304 501 331">Incomplete form of thread</p> 	<p data-bbox="831 349 1414 450">Reduce the drill diameter for tapping hole or apply the drill diameter according to the selection Table for forming taps page 270.</p>
<p data-bbox="172 786 815 813">Overdone form of thread, too small minor diameter</p> 	<p data-bbox="831 882 1414 983">Increase the drill diameter for tapping hole or apply the drill diameter according to the selection Table for forming taps page 270.</p>
<p data-bbox="172 1267 1102 1294">Poor quality of thread surface, yanked off material from surface of thread</p>	<ul data-bbox="831 1357 1414 1509" style="list-style-type: none"> - Improve lubrication: Use forming taps with oil grooves - Increase amount of coolant/lubricant - Use oil for lubricant - Use coated forming tap
<p data-bbox="172 1581 320 1608">Tool breaks</p> 	<ul data-bbox="831 1637 1414 1850" style="list-style-type: none"> - Increase tapping hole diameter - Increased amount of coolant/lubricant - Apply cover coating preventing sticking of material being processed - Check compliance of workpiece with recommendations regarding its plasticity and hardness

6. DIES

6.1. Die construction elements

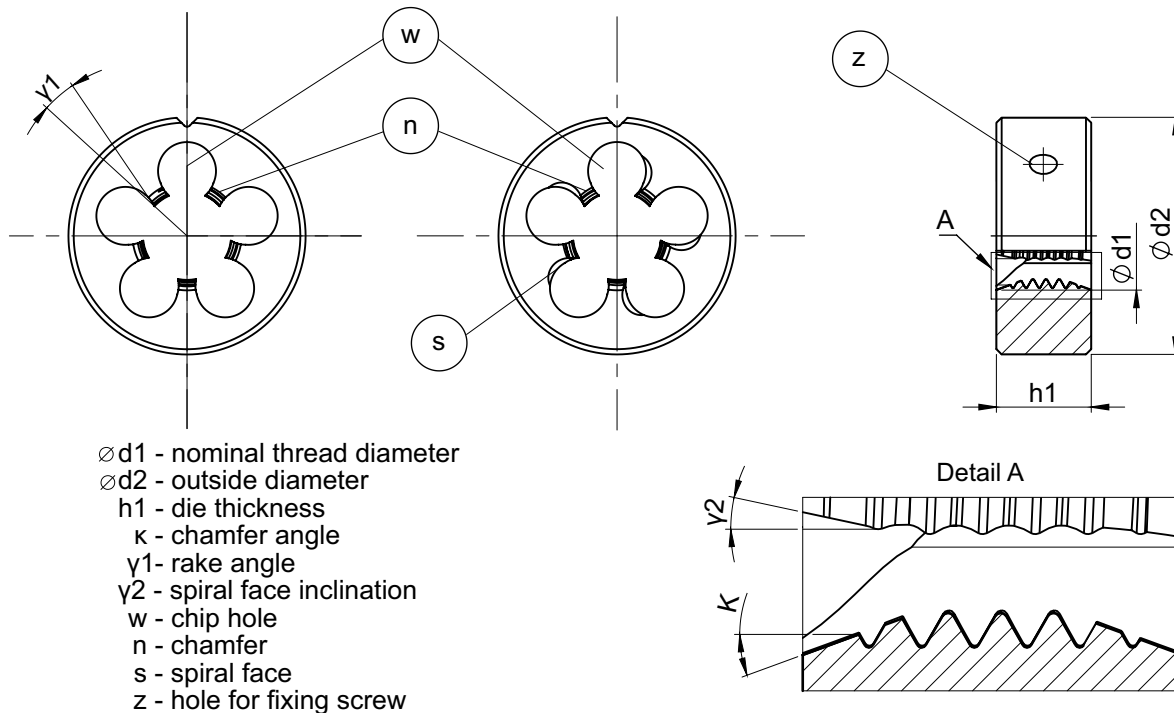

6.2. Dimension standards

Dimension standards assign proper series of dies outer dimensions (diameters, thickness) to nominal standards as well as determine the dimensions connected with dies fixing in the holder (position, size of holes for fixing screws and V-grooves).

Symbol	Standards	Destination
DIN	EN 22 568 (in the past DIN 223) PN-92/M-58070 ISO 2568	Round dies for metric coarse M and MF fine threads, UNC, UNF, BSW, BSF as well as other threads, excluding the pipe threads G and R
DIN	EN 24 231 (in the past DIN 5158) PN-92/M-58161 ISO 4231	Round dies for pipe threads G
DIN	EN 24 230 (in the past DIN 5159) PN-92/M-58160 ISO 4230	Round dies for tapered pipe threads R

6.3. Marking and stamping of dies

Marking

Example: high performance machine die acc. to DIN-EN 22 568 for the thread M12, thread tolerance 6g, for stainless steel

Marking: given in orders, invoices, specifications, on the packages

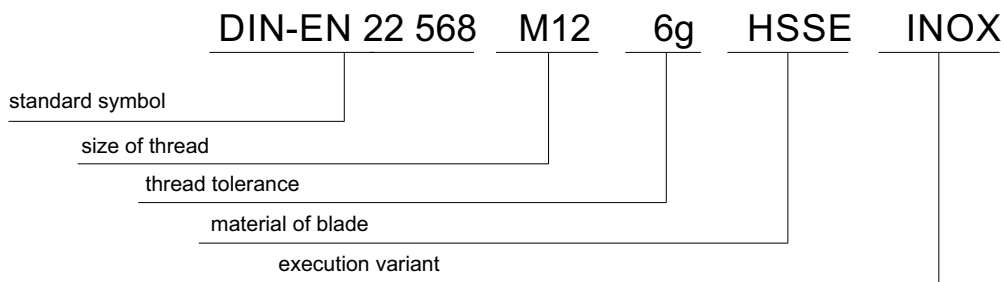

Stamping

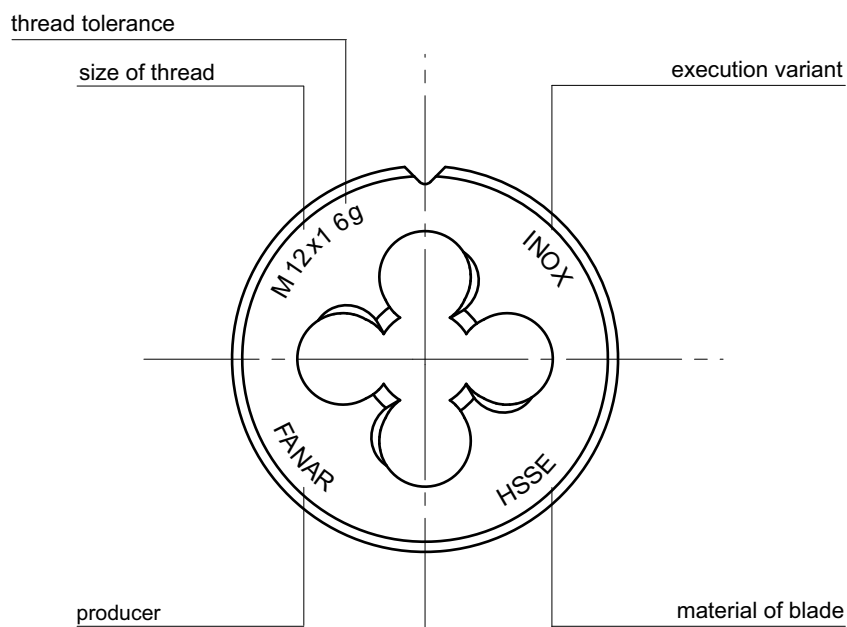

6.4. Cut Thread Tolerances

The threading dies presented in our catalog are designed for cutting the most common and basic for a given type of thread tolerances: for metric thread 6g, for threads UNC, UNF, etc., 2A. On individual request we can manufacture threading dies for other, than the above mentioned, fields of tolerance, e.g. for the metric threads: 4h for tight threads, 6e for threads to be covered with thin galvanized coating.

6.5. Groups of Tools by Applications

800 P N	For processing of structural steel and cast steel with $R_m \leq 800 \text{ MPa}$
800 SPN P N	For processing of structural steel and cast steel with $R_m \leq 800 \text{ MPa}$. Better cut thread quality can be achieved, for use on automatic lathes.
Ms N	For processing of brass and short chip bronze.
INOX P M K N	For processing of stainless steel, cast aluminum and nodular cast iron.

6.6. Chamfer

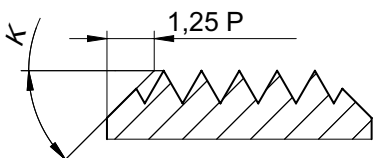
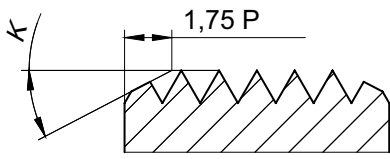
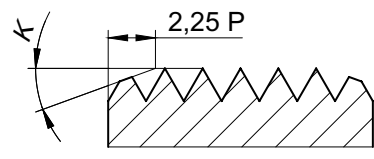
Length	Application	Sketch	Angle
1,25 P	Ms		45°
1,75 P	800		27,5°
2,25 P	INOX		20°

7. GAUGES

7.1. Gauges construction elements

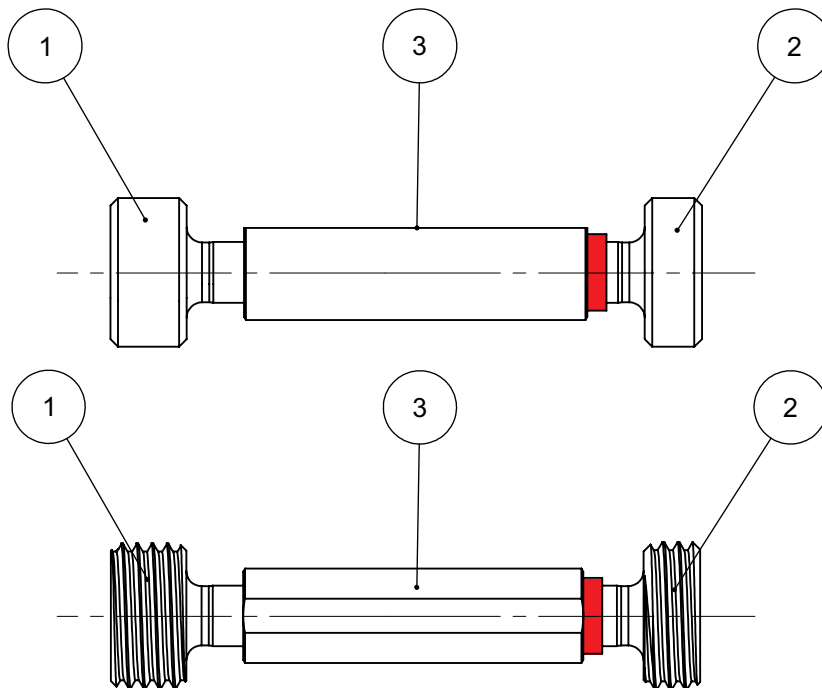

- 1 - GO plug gauge
- 2 - NO GO plug gauge
- 3 - handle

7.2. Types of gauges

7.2.1 Gauges NPT

Flattening equal with workpiece plane

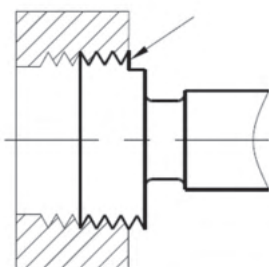

The base depth

Flattening one thread turn above workpiece plane

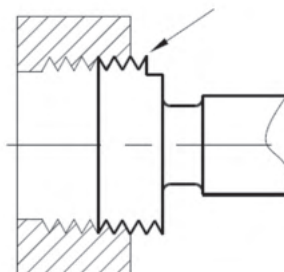

Minimal tapping depth



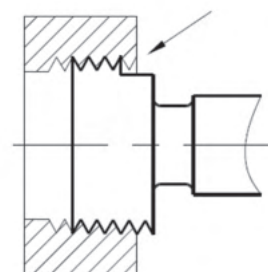

Flattening one thread turn below workpiece plane



Maximum tapping depth

Pipe threads where pressure tight joint are made on the threads according to PN-EN 10226-1, PN-EN 10226-2 (ISO7-1:2000).
Verification by means of limit gauges according to PN-EN 10226-3 (ISO-7-2:2000)

7.2.2 Gauges R, Rc/Rp

<p style="text-align: center;">Gauge No. 1</p> 	<p>Taper full form threaded plug gauge.</p> <p>This gauge is a 1:16 taper full form threaded plug gauge and is suitable for checking the major diameter (D) and pitch diameter (D2) at the gauge plane of internal parallel (Rp) threads and internal taper (Rc) threads.</p>
<p style="text-align: center;">Gauge No. 2</p> 	<p>Taper full form threaded plug gauge with relief.</p> <p>This gauge is a 1:16 taper full form threaded plug gauge with relief of threads and is suitable for checking the major diameter (D) and pitch diameter (D2) at the gauge plane, and the accommodation length of internal parallel (Rp) threads and internal taper (Rc) threads.</p> <p><small>¹Accommodation length: distance from the face of an internally threaded workpiece to the first obstruction which the externally threaded workpiece will encounter on assembly.</small></p>
<p style="text-align: center;">Gauge No. 3</p> 	<p>Parallel full form threaded ring gauge.</p> <p>This gauge is parallel full form threaded ring gauge and is suitable for checking the minor diameter (d1) and pitch diameter (d2) at the gauge plane of taper external (R) threads.</p>
<p style="text-align: center;">Gauge No. 4</p> 	<p>Taper plane ring gauge.</p> <p>This gauge is a 1:16 taper plain ring gauge and is suitable for checking the major diameter (d) and the related useful thread length on taper external (R) threads.</p>
<p style="text-align: center;">Gauge No. 5</p> 	<p>Taper modified thread form check plug gauge</p> <p>This check plug gauge is used to check the dimensions of the parallel threaded ring gauge (gauge No. 3) when manufacturing the ring gauge and for checking the ring gauge for wear.</p>

7.3. Validation of Holes

For checking of the through holes and blind holes, there are used go/no go plug gauges. The go gauge should be inserted into a hole with its own weight or with just a little push. The gauge must not be pushed with excessive force, as it could be jammed. The no go gauge should not let itself to be inserted into a hole.

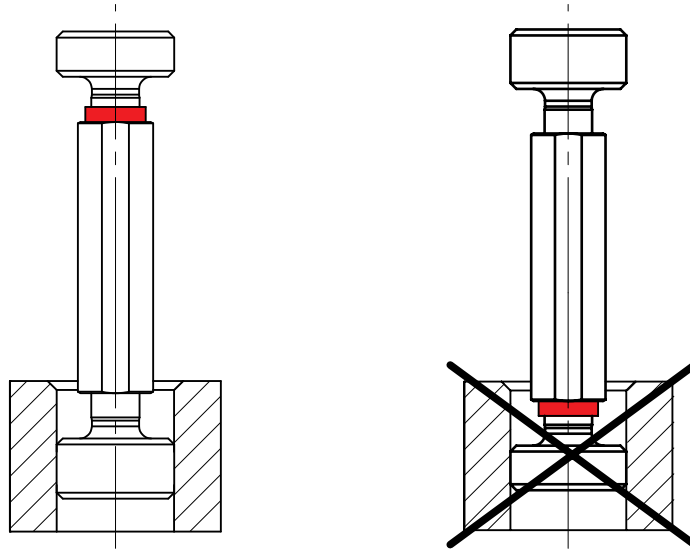

Checking Internal Cylindrical Threads

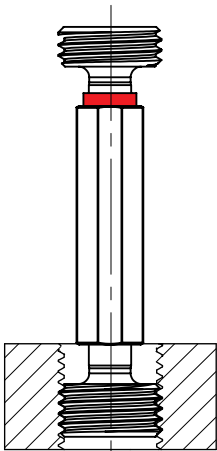

For checking of the internal threads, there are used go and no go thread gauges. **With the go thread gauge** you check the virtual internal thread dimension by checking the bottom dimension of pitch diameter. The go gauge, when manually screwed in, should with no special effort let itself to be screwed in for the whole length of the thread. The thread does not meet requirements, when it proves impossible to screw the gauge in.

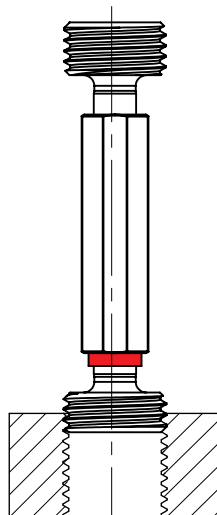

With the no go thread gauge you check whether the pitch diameter exceeds the upper limit dimension. The no go gauge, when manually screwed in, should with no special effort go in **no further than two thread pitches**. If the gauge can be screwed in further than the two pitches, it means the thread does not meet requirements.

7.4. Use of gauges and checking of threads

Checking of internal taper (Rc) and internal parallel (Rp) threads

Stage 1: The taper threaded plug gauge (gauge No. 1) is screwed hand tight into the internal thread. The internal thread is within the permissible tolerance if the end face of the threaded workpiece lies between the step faces, or flush with one of the step faces on the gauge.

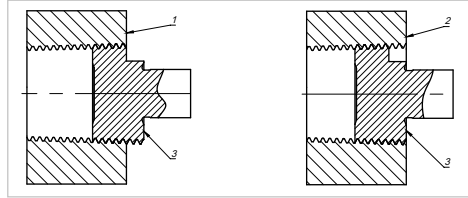

Key:

- 1 - end face of work piece flush with tolerance step on gauge,
- 2 - end face of work piece flush with face of gauge
- 3 - gauge No. 1

Stage 2: The taper threaded plug gauge with relief (gauge No 2) is screwed hand tight into the internal thread. The internal thread is within the permissible tolerances if the end face of the threaded workpiece lies between the step faces, or flush with one of the step faces on the gauge.

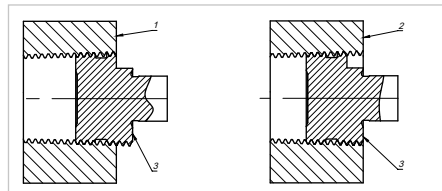

Key:

- 1 - end face of work piece flush with tolerance step on gauge,
- 2 - end face of work piece flush with face of gauge
- 3 - gauge No. 2

Note 1 : If a workpiece is rejected by gauge No. 2 but accepted by gauge No. 1, then this may indicate a lack of accommodation length.

Note 2 : A variation in the relative position of the gauge steps of gauge Nos. 1 and 2 in excess of $0,5P$ but not greater than $1P$ is permissible when the manufacturer and purchaser agree that the use of a thread sealant during assembly of the workpiece will compensate for the increased difference in the gauging results.

Note 3 : In the case of Rp threads, if the depth of chamfer at the pitch diameter of the threads is more or less than $0,5P$, then the gauging result will be slightly affected.

Checking of external taper (R) threads

Stage 1: The threaded ring gauge (gauge No. 3) is screwed hand-tight onto the external thread. The external thread is within the permissible tolerance if the end face of the workpiece lies between the step faces, or flush with one of the step faces on the gauge.

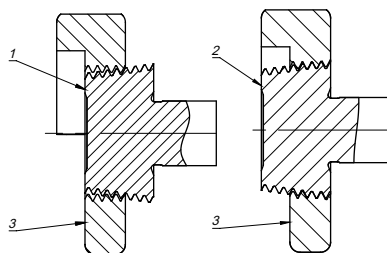

Key:

- 1 - end face of work piece flush with tolerance step on gauge,
- 2 - end face of work piece flush with face of gauge
- 3 - gauge No. 3

Stage 2: The taper plain ring gauge (gauge No. 4) is positioned hand tight over the external thread. The external thread is within the permissible tolerances if the end face of the threaded workpiece lies between the step faces, or flush with one of the step faces of the gauge and the roots of all threads within the area covered by the gauge are fully formed.

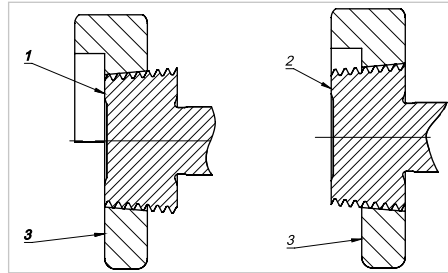

Key:

- 1 - end face of work piece flush with tolerance step on gauge,
- 2 - end face of work piece flush with face of gauge
- 3 - gauge No. 4

Note: A variation in the relative positions of the gauge steps of gauge Nos. 3 and 4 in excess of $0,5P$ but no greater than $1P$ is permissible when the manufacturer and purchaser agree that the use of a thread sealant during the assembly of the workpiece will compensate for the increased difference in the gauging results.

Checking of taper plug gauges wear (gauge Nos. 1 and 2)

The pitch diameter of taper threaded plug gauges may be checked with the parallel modified thread form check ring gauge (gauge No. 6). The major diameter of taper threaded plug gauges shall be checked by direct measurement.

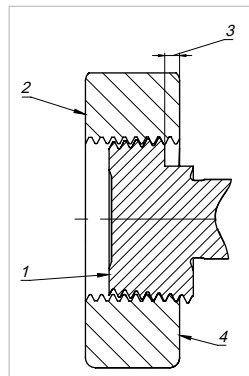

Key:

- 1 - gauges No 1 and 2,
- 2 - gauges No 6,
- 3 - distance from face of step on plug gauge to face of ring gauge shall be l_{13}
(see PN-EN 10226-3:2005 table 16)
- 4 - this face marked to indicate position of gauge plane

Checking of parallel ring gauges wear (gauge No 3)

Parallel full form threaded ring gauges shall be checked by using the taper modified thread form check plug gauges at the pitch diameter. The minor diameter shall be checked by direct measurement.

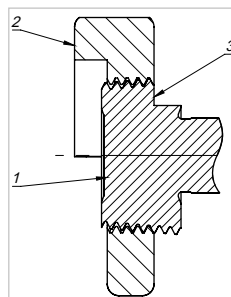

Key:

- 1 - gauges No 5
- 2 - gauges No 3
- 3 - distance from face of step on plug gauge to face of ring gauge shall be l_{14}
(see PN-EN 10226-3:2005 table 16)
- 4 - this face marked to indicate position of gauge plane

8. TWIST DRILLS

8.1. Nomenclature of Twist Drills

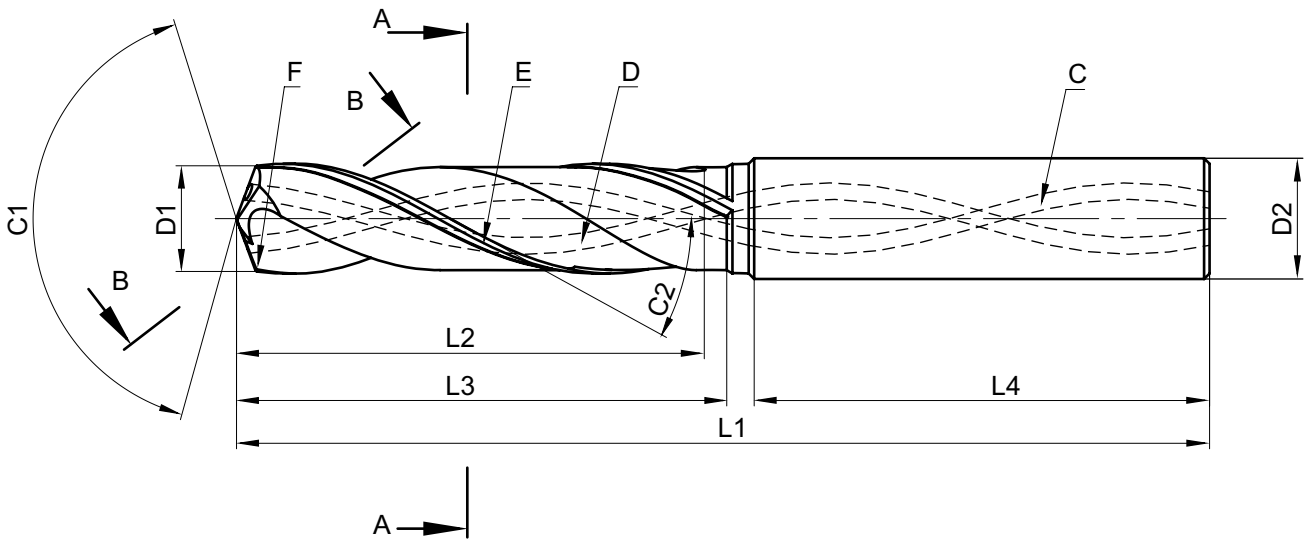

- C - channel supplying coolant
- D - chip flute
- E - margin
- F - rake face
- G - primary clearance surface
- H - secondary clearance surface
- I - chamfer
- J - chamfer edge

with no web thinning

with web thinning

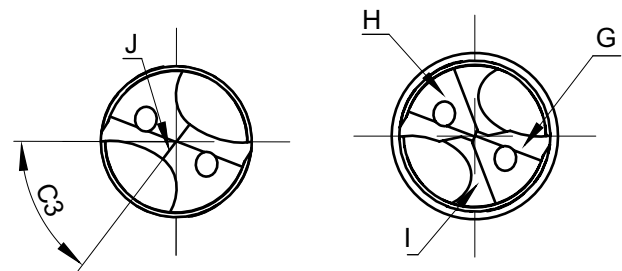

- L1 - total length
- L2 - chip flutes length
- L3 - margin length
- L4 - shank length
- D1 - working part diameter
- D2 - shank diameter
- D3 - core diameter
- D4 - spacing of cooling channels
- D5 - diameter of cooling channels
- C1 - point angle
- C2 - Helix angle
- C3 - chisel angle
- C4 - clearance angle
- C5 - angle of primary clearance surface
- C6 - angle of secondary clearance
- G1 - margin width
- G2 - lowering of margin
- B - blade width

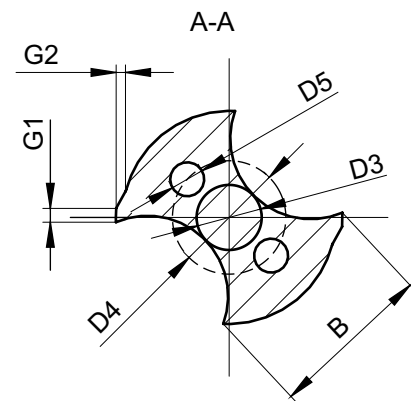

B-B

Types of Drill Clearance Surfaces

Four faced

Conical (eccentric)

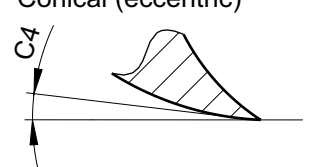
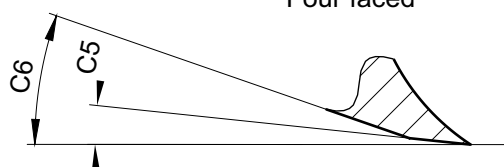

8.2. Cooling and Lubrication Conditions

Application of Coolant:

- It is recommended when the drilling depth is at least twice greater than the diameter
- It is a must with depths five times greater than the drill diameter
- With application of external cooling, the coolant should be fed not only with the appropriate pressure, but also in the proper manner.

Methods of Coolant Supply:

Internal:

- Should be applied always, when the depth of the hole is at least three times greater than the diameter.
- Internal cooling is always recommended to avoid blocking of chips.

External:

- To improve chip evacuation, at least one coolant nozzle (two, if the drill bit is fixed) should be directed close to the axis of the tool.
- External cooling helps to avoid the formation of buildup on the edges, due to lowering the edges' temperature.
- External cooling is allowed for materials, which give short chips.

8.3. Problems and Troubleshooting

Problem: Buildup on edges	
Too low cutting speed	Increase cutting speed
Too high temperature of tool's edges	Apply cooling
Too great negative rake angle	Sharpen the cutting edge
Wear of coating	Coating on the edge
Too little oil in coolant	Increase amount of oil in coolant
Problem: Chipping off corners	
Excessive runout.	Use grip with better mounting precision
Excessive feed.	Decrease feed.
Insufficient amount of coolant (thermal cracking)	Check coolant pressure
Low rigidity of tool holding system	Check rigidity of tool's mount in the grip
Problem: Chipping off corners	
Excessive runout.	Use grip with better mounting precision
Excessive feed.	Decrease feed.
Discontinuous cutting process	Check coolant pressure
Low rigidity of tool holding system	Check rigidity of tool's mount in the grip

Problem: Excessive wear of the cutting edge	
Excessive runout	Use grip with better mounting precision
Excessive feed	Decrease feed
Discontinuous cutting process	Check coolant pressure
Low rigidity of tool holding system	Check rigidity of tool's mount in the grip
Problem: Chipping on cutting edge	
Excessive runout	Use grip with better mounting precision
Unstable cutting conditions	Check cutting parameters
Critical tool wear	Change tool more often
Too hard material	Select tool suitable for workpiece material
Problem: Wear on the lands	
Excessive runout	Use grip with better mounting precision
Low coolant pressure	Use pure oil or emulsion with more oil content
Too high cutting speed	Decrease cutting speed
Buildup formed by workpiece material	Select tool suitable for workpiece material
Problem: Wear of the chisel edge	
Too low cutting speed	Increase cutting speed
Excessive feed	Decrease feed
Too small chisel	Check dimensions
Problem: Plastic deformation	
Too high cutting speed	Decrease cutting speed
Excessive feed	Decrease feed
Poor coolant supply	Check coolant pressure and setting of nozzles
Too low rigidity of tool holding system	Use VHM drill bit
Problem: Abrasion of coating from the edge	
Too much friction	Apply coolant with greater content of oil or additives
Remove at an angle	Decrease feeding speed at removal
Buildup formed by workpiece material	Reduce number of tool's regenerations
Problem: Chip block	
Too low cutting speed	Increase cutting speed
Excessive feed	Decrease feed
Too small chip flutes	Select tool with proper geometry
Poor rinsing off chips	Apply internal cooling

9. TAP HOLDERS

9.1. Tap holders „SOFT SYNCHRO”

MASTERSYNC

Rule of action

At the heart of MasterSYNC is a precisely machined flexure which provides axial and radial compensation for the unavoidable discrepancy between the machine feed advance and the actual tap pitch. By compensating for this error, the thrust forces acting on the tap are dramatically reduced. The result is the longest possible tap life, 100 % improvement or more, and much better quality threads.

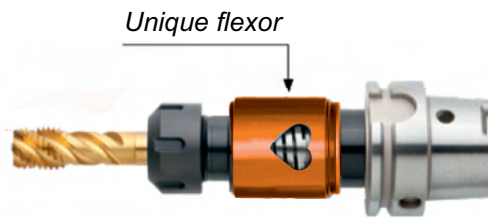

By limiting the axial compensation travel, and torsional forces acting on the flexure, millions of holes can be tapped without causing the MasterSYNC holder to fatigue, take a set, or wear out.

Axial micro compensation is closely limited (mechanically secured)

Torque is transmitted through the drive pins – not through the flexure.

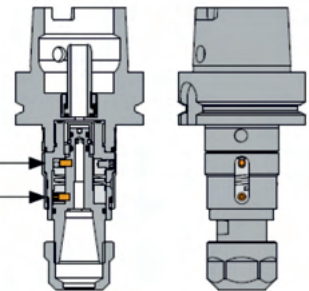

High Pressure Internal Coolant and MQL (Minimum Quantity Lubrication)

High pressure internal coolant system may be used at pressures up to 80 bar without affecting the axial compensation. Fanar can provide tools ready for Minimum Quantity Lubrication through the spindle. Our system provides direct flow of air and lubricant to the back of the tap.

IK

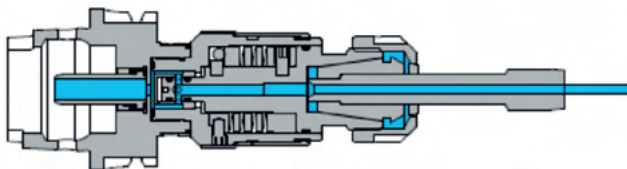

High Pressure Internal Coolant with increased flow rates

MQL

Adjusting screw

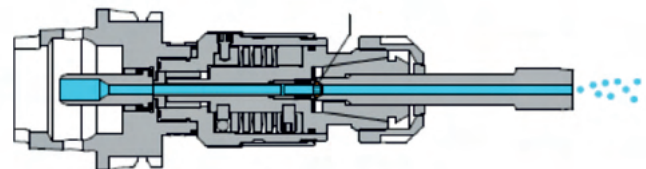

Minimum Quantity Lubrication Available for 1 channel or Multi channel systems

9.2. Quick-change adapters with safety clutch for taps

RECOMMENDED TORQUE VALUES FOR TAPPED MATERIALS WITH RM=1000 MPA

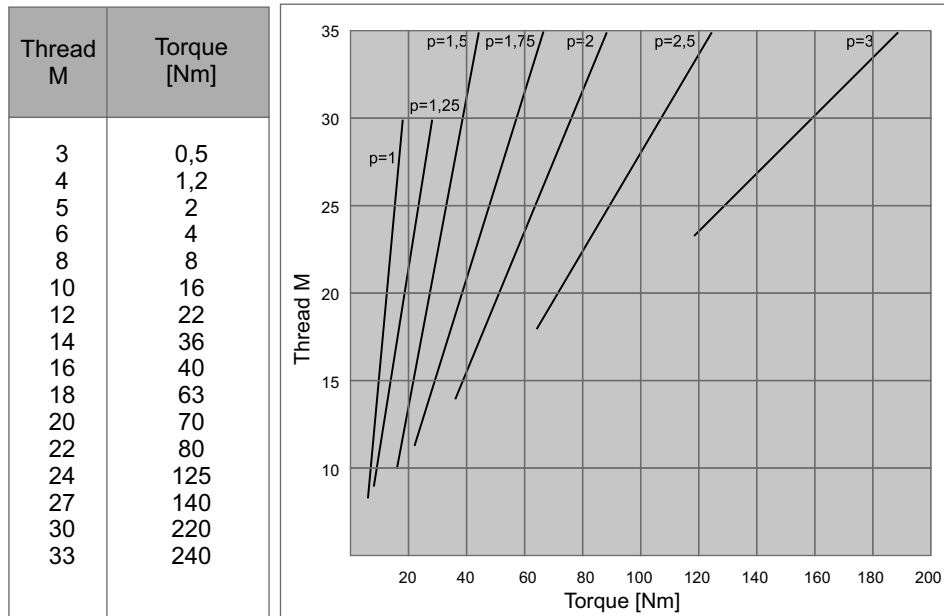

The values given are approximate and may be different depending on specific operating conditions

9.3. ER collets mounting

SHANK RUNOUT MOUNTED IN THE ER COLLET

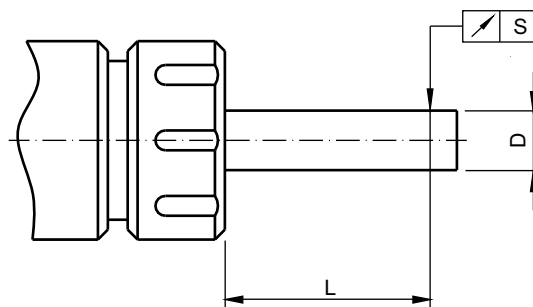

D	L	S
1-1,6	6	0,008
1,6-3	10	0,008
3-6	16	0,008
6-10	25	0,008
10-18	40	0,008
18-26	50	0,008
26-40	60	0,008

9.4. Toolholders balance

Definition of unbalance

Unbalance is a displacement of the center of gravity of the rotating mass from the axis of rotation. The rotating mass includes: machine spindle, toolholder, intermediate components (collets), other additional elements of toolholders (nuts) and tool. The reason of unbalance is geometric asymmetry, tolerance of, mounting errors, etc. Unbalance causes vibration of the setup, which reduce tool life and decrease quality of machining. To limit to an acceptable level of unbalance minimize clearances on the spindle and set suitable tools and toolholders. For most demanding applications it may be necessary not only balancing the toolholders, but also the tools.

Balancing

Balancing is to reduce the unbalance by moving the center of rotating mass in the direction of the axis. This is done by ensuring the proper geometry and adding additional weight or removing. This target can only be achieved to some degree, as will always be residual unbalance.

Balance accuracy classes

From an economic perspective it is not profitable too much tightening of requirements for rotating mass balance. In order to achieve a compromise between the technical and economic aspects, norm ISO 1940 introduced balance accuracy classes. It identifies the types of applications for each class, and so:

- G6,3 class is designed for machine parts and general use machines
- G2,5 class is designed for high speed machine parts.

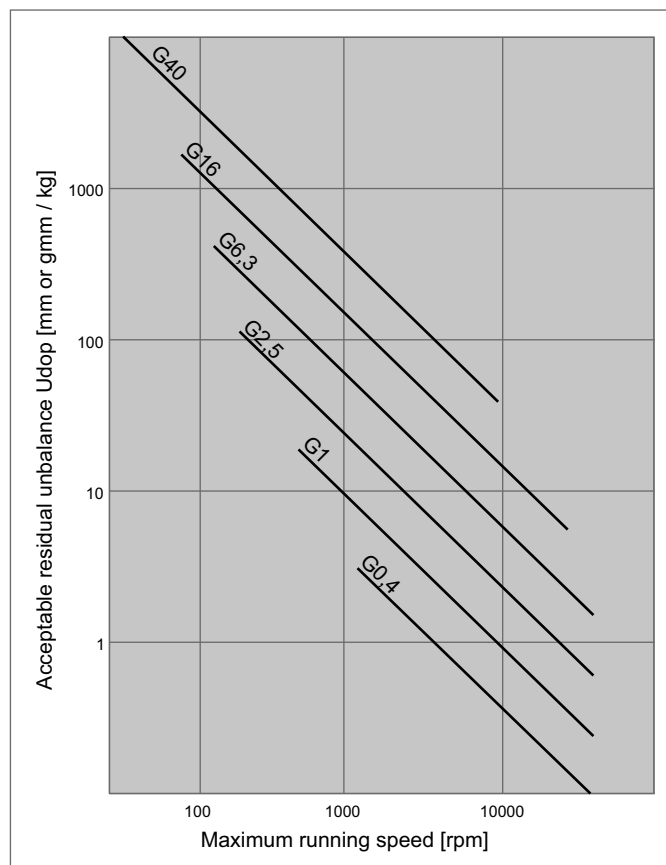

9.5. Toolholders shanks

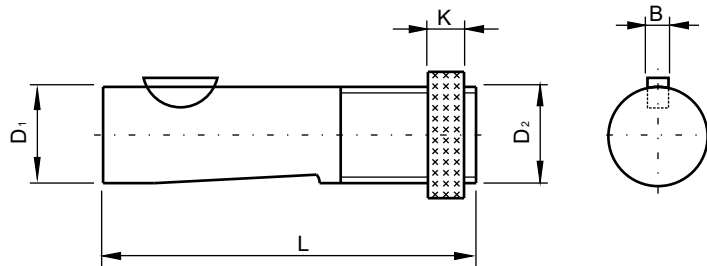
TR wg DIN-6327

Shank	D ₁	D ₂	L	B	K
TR20	20	TR20x1,5	88	5	12
TR28	28	TR28x2	95	6	12
TR36	36	TR36x2	118	8	14
TR48	48	TR48x2	144	10	18

Features:

- Toolholders made of nickel-chromium-molybdenum steel, carburized and hardened to 58HRC.
- Precision grinded shank in g5 tolerance.

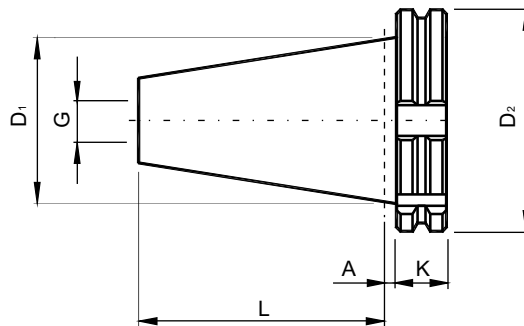
ISO wg DIN-69871 A

Tapper	D ₁	D ₂	L	A	K	G
ISO30	31,75	50,00	47,80	3,2	15,9	M12
ISO40	44,45	63,55	68,40	3,2	15,9	M16
ISO50	69,85	97,50	101,75	3,2	15,9	M24

Versions:

- DIN-69871 A - shank without internal cooling
- DIN-69871 AD - with a central hole
- DIN-69871 AD+B - with a central hole and the holes in the flange

Features:

- Toolholders for machines with automatic tool changing
- For toolholder mounting in the machine are used pull studs
- Toolholders made of nickel-chromium-molybdenum steel, carburized and hardened to 58HRC.
- Surface of taper precision grinded in AT3 class.
- Tool sockets made of 0,007 mm maximum runouts.
- Body balanced in G6,3/8000rpm class in standard version

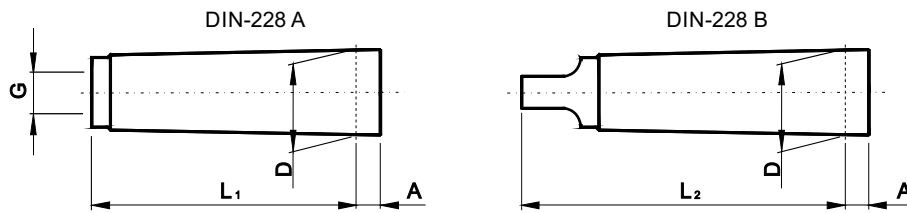
MORSE'A wg DIN-228

Taper	D	A	L ₁	L ₂	G
MK1	12,065	3,5	53,5	62,0	M6
MK2	17,780	5,0	64,0	75,0	M10
MK3	23,825	5,0	81,0	94,0	M12
MK4	31,267	6,5	102,5	117,5	M16
MK5	44,399	6,5	129,5	149,5	M20

Features:

- Toolholders made of nickel-chromium-molybdenum steel, carburized and hardened to 58HRC.
- Connecting surfaces precision grinded in AT3 class.

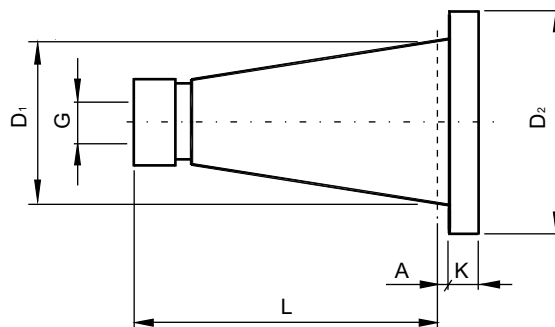
DIN wg DIN-2080

Taper	D ₁	D ₂	L	A	K	G
DIN30	31,75	50,0	68,4	1,6	8	M12
DIN40	44,45	63,0	93,4	1,6	10	M16
DIN50	69,85	97,5	126,8	3,2	12	M24

Features:

- Toolholders made of nickel-chromium-molybdenum steel, carburized and hardened to 58HRC.
- Surface of taper precision grinded in AT3 class.
- Tool sockets made of 0,007 mm maximum runouts.

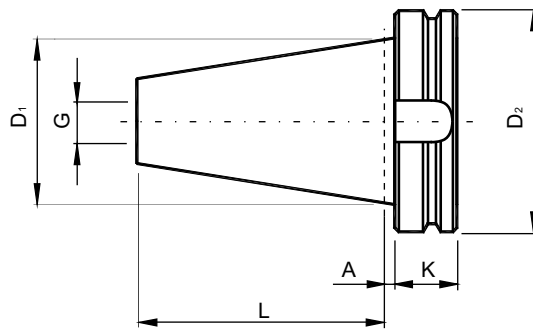
MAS BT wg JIS B6339

Taper	D ₁	D ₂	L	A	K	G
BT30	31,75	46	48,4	2	22	M12
BT40	44,45	63	65,4	2	27	M16
BT50	69,85	100	101,8	3	38	M24

Versions:

- shank without internal cooling
- with a central hole
- with a central hole and the holes in the flange

Features:

- Toolholders for machines with automatic tool changing
- For toolholder mounting in the machine are used pull studs
- Toolholders made of nickel-chromium-molybdenum steel, carburized and hardened to 58HRC.
- Surface of taper precision grinded in AT3 class.
- Tool sockets made of 0,007 mm maximum runouts.
- Maximum running speed 10 000 rpm in standard version

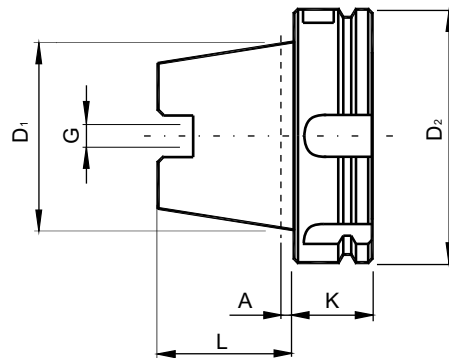
HSK wg DIN-69893 A

Taper	D ₁	D ₂	L	A	K	G
HSK40	30	40	20	4,0	20	M12x1
HSK50	38	50	25	5,0	26	M16x1
HSK63	48	63	32	6,3	26	M18x1
HSK80	60	80	40	8,0	26	M20x1,5
HSK100	75	100	50	10,0	29	M24x1,5

Features:

- Toolholders for machines with automatic tool changing
- Toolholders made of nickel-chromium-molybdenum steel, carburized and hardened to 58HRC.
- Surface of taper precision grinded in AT3 class.
- Tool sockets made of 0,007 mm maximum runouts.
- Body balanced in G6,3/8000rpm class in standard version
- Shank design provides axial positioning accuracy, high rigidity, high torque transfer at high speeds

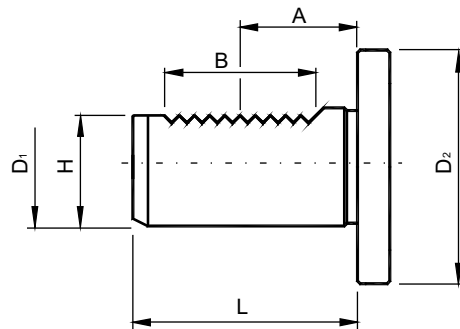
VDI wg DIN-69880

Shank	D_1	D_2	H	L	A	B
VDI20	20	50	18	40	21,7	24
VDI25	25	58	23,5	48	21,7	24
VDI30	30	68	27	55	29,7	40
VDI40	40	83	36	63	29,7	40
VDI50	50	98	45	78	35,7	48

Features:

- Toolholders are made of chrome-manganese steel, carburized and hardened to 58HRC
- Cylindrical surface of shank is grinded in h6 tolerance

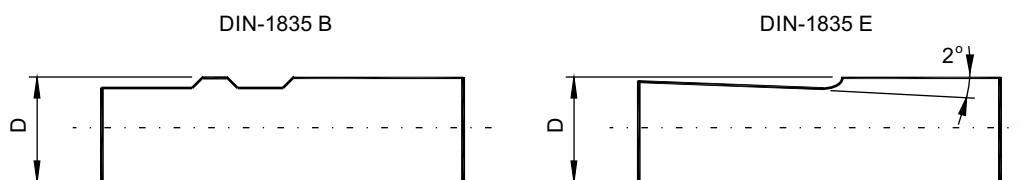
CYLINDRICAL wg DIN-1835

Weldon Shank	D
W20	20
W25	25
W32	32
W40	40
W50	50

Versions:

- DIN-1835 A - straight cylindrical shank
- DIN-1835 B - WELDON: cylindrical shank with flats parallel to the axis of the cylinder
- DIN-1835 E - WHISTLE-NOTCH: cylindrical shank with 2 degrees of flattening

Features:

- Toolholders made of nickel-chromium-molybdenum steel, carburized and hardened to 58HRC.
- Cylindrical surface of shank is grinded in h6 tolerance

10. END MILLS

10.1. End mill construction elements

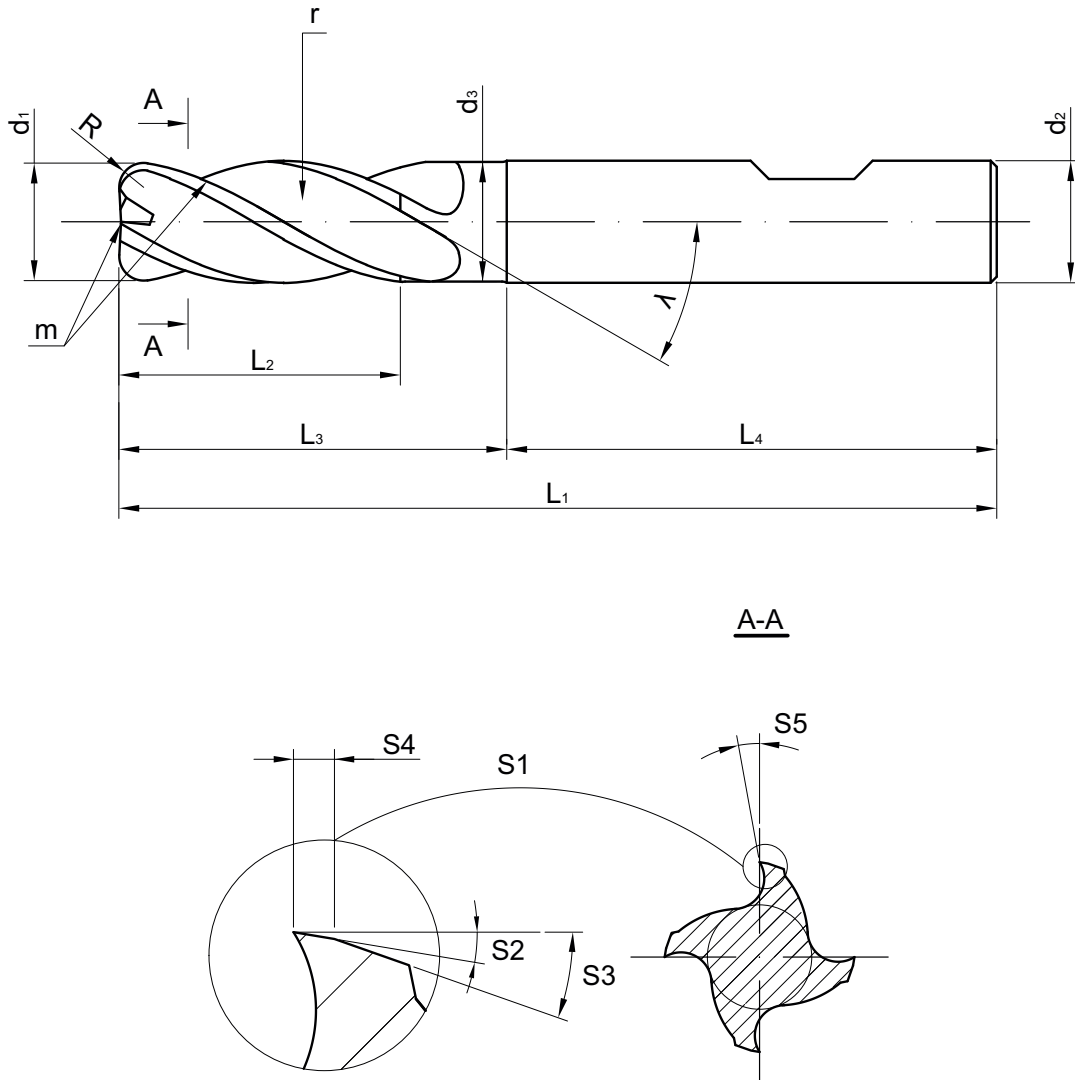

L1 - overall length
 L2 - length of cut
 L3 - reach length
 L4 - shank length
 d1 - working part diameter
 d2 - shank diameter
 d3 - neck diameter
 r - chip flute

λ - helix angle
 R - corner radius
 S1 - relief
 S2 - I relief angle
 S3 - II relief angle
 S4 - width of I relief
 S5 - rake angle
 m - cutting edges

10.2. Corner variants



Sharp corner		
Ball nose	Corner radius	Corner chamfer

10.3. Neck



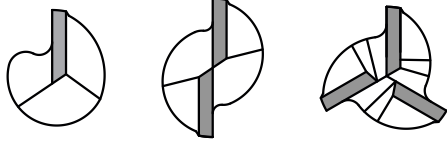

Neck of milling cutter is designed for extension working part of a tool. The table below shows a difference between end mills with and without neck.

	1st pass	2nd pass
With neck		
Without neck		

10.4. Flutes number

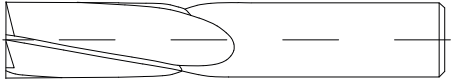
<p>Low number of flutes</p>		<ul style="list-style-type: none"> • Bigger capacity of flutes • Possibility of working with a larger width ae • Easier chip evacuation
<p>More flutes</p>		<ul style="list-style-type: none"> • Larger core • Greater rigidity of the tool • Better surface quality • Higher feed values

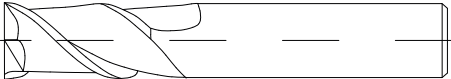
10.5. Helix angle

<p>Smaller helix angle</p>	<p>10°</p>  <p>30°</p> 	<ul style="list-style-type: none"> • Lower risk of pulling out of the holder • Higher risk of vibrations
<p>Bigger helix angle</p>	<p>45°</p>  <p>60°</p> 	<ul style="list-style-type: none"> • More teeth in workpiece in the same time • Longer cutting edges • Less vibration • Better surface quality

10.6. Variable helix angle and pitch

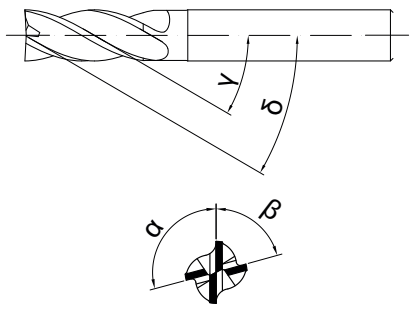
Unequal helix angle and pitch		<ul style="list-style-type: none"> • Cause that intervals between peaks of cutting forces are irregular • Reduce vibrations • Increase tool life • Allow to work with high cutting speeds.
-------------------------------	---	--

10.7. Shank types

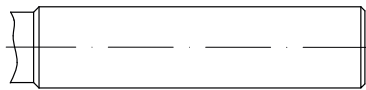
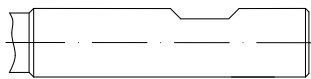
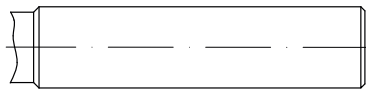
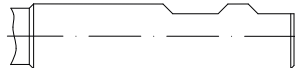
Diameter	Cylindrical- Form HA	Weldon shank - Form HB
Ø6 - Ø20		
Ø25 - Ø32		

10.8. Designation and application

10.8.a. Tool groups according to application

<p>MASTERMILL</p> <p>P M K N S</p>	<p>High performance end mills dedicated to work on machining centers, for machining steel, stainless steel up to 45 HRC, cast iron and difficult to machine materials based on titanium and nickel.</p>
<p>X-MILL</p> <p>P M K</p>	<p>General purpose end mills for machining materials with hardness up to 35 HRC.</p>
<p>AL</p> <p>N</p>	<p>Group of tools with cutting geometry optimized to machining non-ferrous materials. Polished flutes and TB coating allow high performance machining of aluminium and copper alloys.</p>
<p>HRC</p> <p>H</p>	<p>End mills produced of comented carbide grade with nano-grain size (0,2 µm), dedicated for machining materials in hardened condition. Optimized geometry and TS coating allow machining materials with higher hardness than 65 HRC.</p>

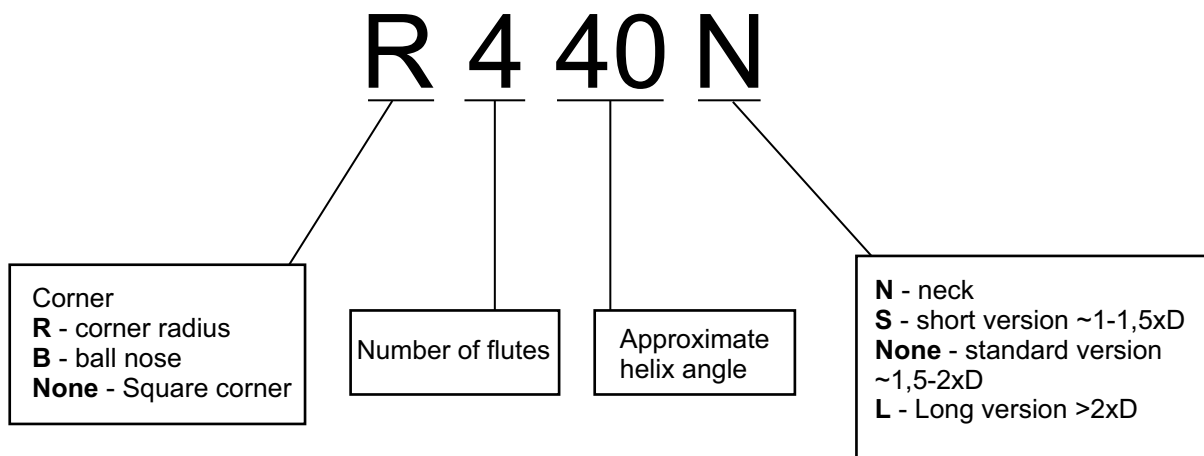

10.8.b. Designation

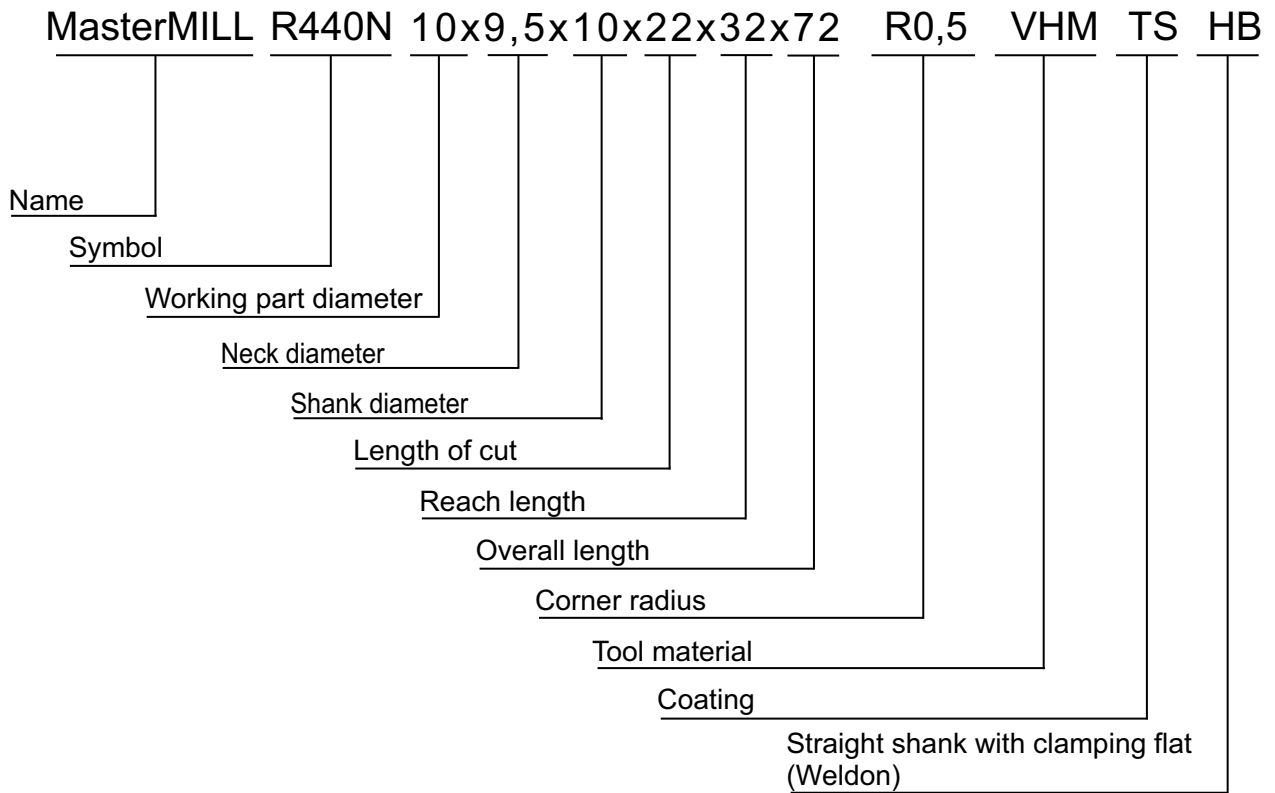

10.8.c. Marking

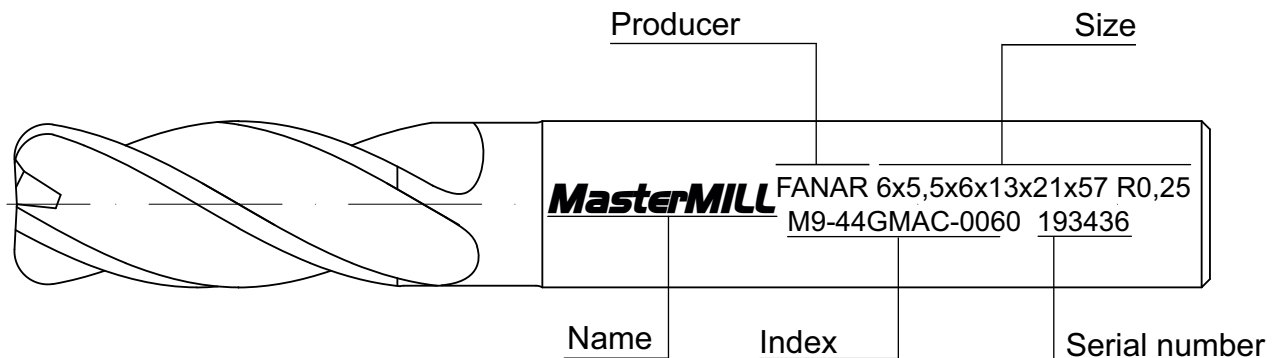

10.9. Technological recommendations for milling

10.9.a. Effective milling is the result of:

- technical condition of the machine
- the proper selection of the end mills
- the selection of a precise and rigid holder
- rigid and securely fixation of work piece
- choice of coolant
- machine processing strategy

10.9.b. Correct tool selection

Milling cutter should be selected from selection table according to machined workpiece material. Adjust the cutter suitable for the material and dimensions; as short as possible, with a short cutting length and a larger diameter. For grooving choose end mills with a smaller number of flutes (2-3) for good chip evacuation. For profiling use 4-6 flutes cutters, in order to obtain a better surface quality and durability of the cutter.

10.9.c. Holder

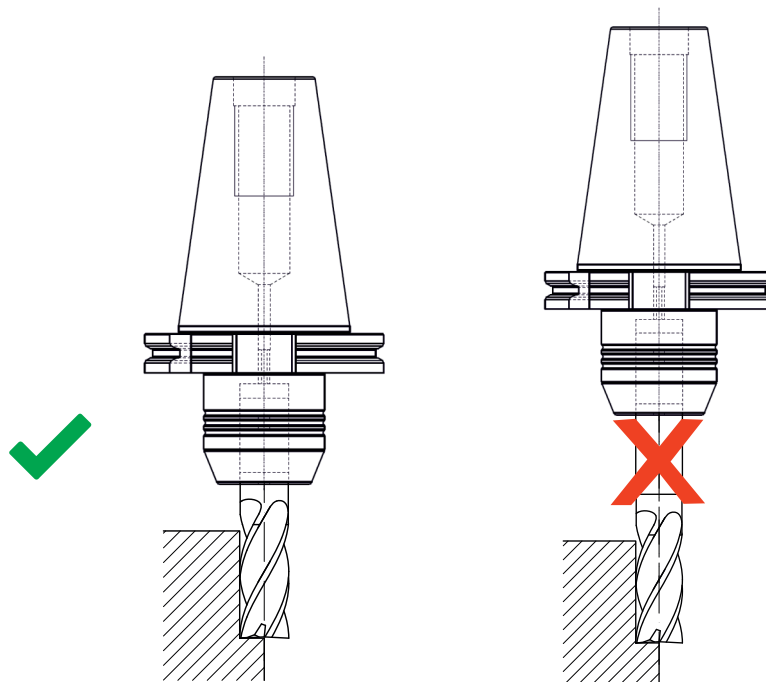

For high speed milling use the hydraulic holder or with shrink fit short reach, ensuring rigidity and precision mounting. Always secure the minimum influence of the tool holder.

10.9.d. Dry and wet milling

Dry milling increases the life of the cutting edge.

The milling operation in contrast to drilling is an inherently intermittent process. This causes the temperatures generated at the cutting edge to constantly fluctuate between various levels of hot and cold.

The cutting edge of a mill is subjected to thermal shocks and cyclic stresses that can result in cracking and, decreasing of tool life.

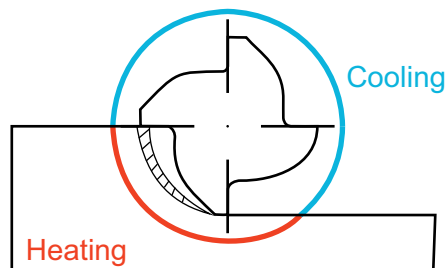

The best solution to facilitate chip removal and prevent recutting of chips is to use compressed air systems.

Justified cases of using coolant during working with carbide cutters are:

- finishing of stainless steel and aluminium
- milling of heat resistant alloys
- milling of thin walled components.

10.9.e. Processing technology and strategy

To increase the tool life, the climb-milling is recommended. Milling of the pockets usually begins with a pre-drill the hole. It is also used a spiral interpolation or linear ramping.

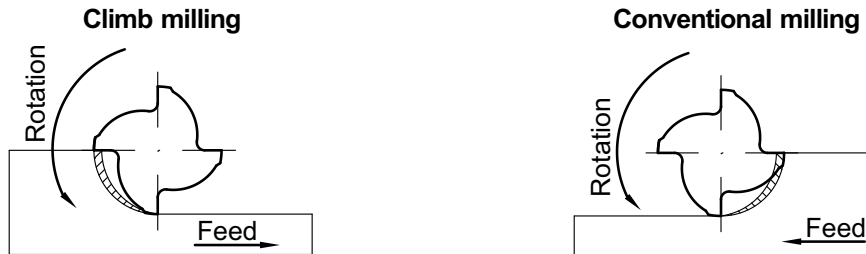

In these cases, the feed rate should be reduced to 25-50% of the values shown in the tables and cutting speed used as for grooving. In any case operating conditions can vary considerably. Therefore at the beginning of machining is recommended to reduce cutting to 50% from the tables selection, and then increasing to them. Deviations from the described conditions, exceeding the axial depth A_p and width A_e , can lead to a reduction in the cutting parameters V and f_z from those given in the tables.

10.9.f. High speed milling

HSM (High Speed Machining) – machining strategies based on chip thickness control and tool load reduction. By properly modifying the machining parameters, and in some cases using tools with a special design, it is possible to achieve lower mechanical and thermal load of cutting edges while increasing productivity.

Influence of the cutting width on the thickness of the chip.

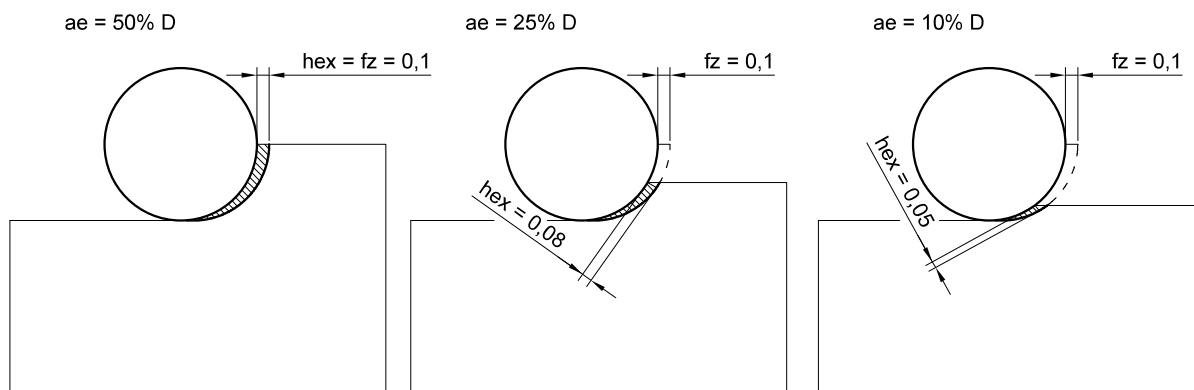

The most common milling strategies based on chip thickness control are:

- Trochoidal milling
- High Feed Milling (HFM)

Trochoidal milling

High Feed Milling - Milling strategy developed to reduce chip thickness by using a tool with a special face geometry. This kind of a tool allows machining with several times higher feed rates than conventional machining.

- **Very small milling width a_e and small wrap angle of the tool** - reduction of chip thickness hex and radial forces
- **Highest possible cutting speed V_c and number of flutes** - high feed speeds and productivity
- **Full length of cutting edges in use** – even wear of cutting edges

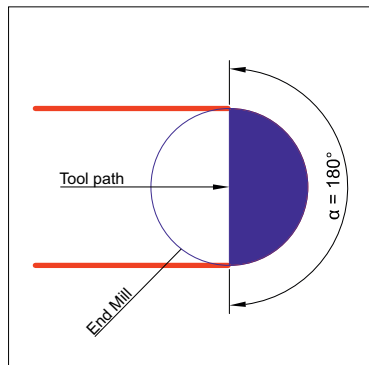

Milling a groove in a full material

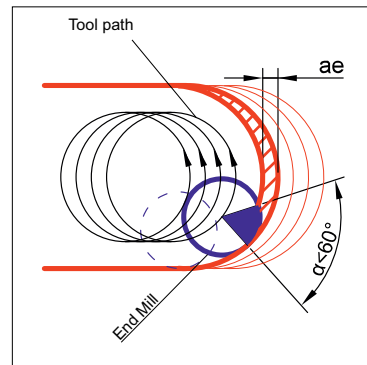

Trochoidal milling

HFM - High Feed Milling

High Feed Milling - Milling strategy developed to reduce chip thickness by using a tool with a special face geometry. This kind of a tool allows machining with several times higher feed rates than conventional machining.

- **Very low cutting depth a_p** - reduced chip thickness hex and radial forces
- **Large cutting width a_e and feed per tooth f_z** - even wear of the specially shaped cutting edge
- **Highest possible feed per tooth and number of teeth** - high feed speeds and productivity

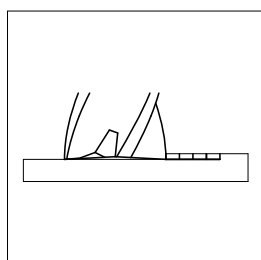

Face of standard end mill

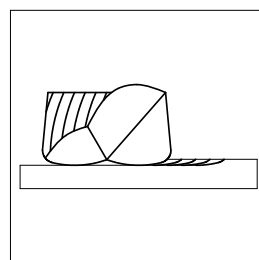

Face of milling cutter for High Feed Milling

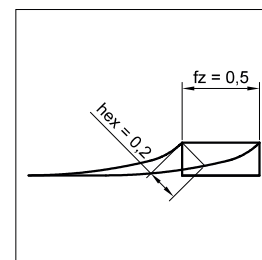

Comparison of the chip shape with the same feed per tooth

Machine requirements:

- High speed spindle
- High dynamics of the machine - frequent changes of direction and feed values
- Balancing tools with a tool holder
- Necessity to be able to program the toolpath - CAM software
- Proper tool design

10.10. Formulas and tables

10.10.a. Basic formulas

Symbol	Unit	Name	Formula
V_c	m/min	Cutting speed	$v_c = \frac{d_1 \times \pi \times n}{1000}$
n	1/min	Rotational speed	$n = \frac{1000 \times v_c}{d_1 \times \pi}$
V_f	mm/min	Rate of feed	$v_f = f_z \times n \times z$
f_z	mm	Feed per tooth	$f_z = \frac{v_f}{n \times z}$

d_1 [mm] - diameter of milling cutters
 z - number of teeth

10.10.b. Cutting speed factors depending on the working width a_e - for solid carbide end mills

a_e / D	1-0,5	0,4	0,3	0,2	0,1	0,05	0,04
Cutting speed multiplier V_c	1	1,1	1,2	1,3	1,4	2,5	3

10.10.c. Ball nose end mills real cutting diameter

$\varnothing d_1$	Depth of cut a_p [mm]																
	0,01	0,02	0,03	0,04	0,05	0,08	0,1	0,15	0,2	0,3	0,5	0,8	1,0	2,0	3,0	4,0	5,0
1	0,199	0,280	0,341	0,392	0,436	0,543	0,600	0,714	0,800	0,917	1,000	-	-	-	-	-	-
2	0,282	0,398	0,486	0,560	0,624	0,784	0,872	1,054	1,200	1,428	1,732	1,960	2,000	-	-	-	-
3	0,346	0,488	0,597	0,688	0,768	0,967	1,077	1,308	1,497	1,800	2,236	2,653	2,828	2,828	-	-	-
4	0,399	0,564	0,690	0,796	0,889	1,120	1,249	1,520	1,744	2,107	2,646	3,200	3,464	4,000	-	-	-
5	0,447	0,631	0,772	0,891	0,995	1,255	1,400	1,706	1,960	2,375	3,000	3,666	4,000	4,899	4,899	-	-
6	0,489	0,692	0,846	0,977	1,091	1,376	1,536	1,873	2,154	2,615	3,317	4,079	4,472	5,657	6,000	-	-
8	0,565	0,799	0,978	1,129	1,261	1,592	1,778	2,170	2,498	3,040	3,873	4,800	5,292	6,928	7,746	8,000	-
10	0,632	0,894	1,094	1,262	1,411	1,782	1,990	2,431	2,800	3,412	4,359	5,426	6,000	8,000	9,165	9,798	10,000
12	0,693	0,979	1,198	1,383	1,546	1,953	2,182	2,666	3,072	3,747	4,796	5,987	6,633	8,944	10,392	11,314	11,832
14	0,748	1,058	1,295	1,495	1,670	2,111	2,358	2,883	3,323	4,055	5,196	6,499	7,211	9,798	11,489	12,649	13,416
16	0,800	1,131	1,384	1,598	1,786	2,257	2,522	3,084	3,555	4,341	5,568	6,974	7,746	10,583	12,490	13,856	14,832
18	0,848	1,199	1,468	1,695	1,895	2,395	2,676	3,273	3,774	4,609	5,916	7,419	8,246	11,314	13,416	14,967	16,125
20	0,894	1,264	1,548	1,787	1,997	2,525	2,821	3,451	3,980	4,862	6,245	7,838	8,718	12,000	14,283	16,000	17,321

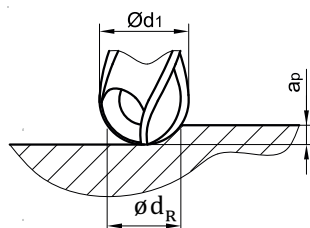

$$\varnothing d_R = 2 \cdot \sqrt{a_p (\varnothing d_1 - a_p)}$$

11. INFORMATION TABLE

11.1. Recommended Hole Diameters for Taps

ISO Metric Threads

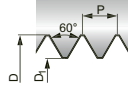

M ISO Metric coarse thread DIN 13

Nom. size		D ₁ (6H)		
D mm	P mm	min. mm	max. mm	
M 1	0,25	0,729	0,785	0,75
1,1	0,25	0,829	0,885	0,85
1,2	0,25	0,929	0,985	0,95
1,4	0,3	1,075	1,142	1,1
1,6	0,35	1,221	1,321	1,25
1,7	0,35	1,321	1,421	1,35
1,8	0,35	1,421	1,521	1,45
2	0,4	1,567	1,679	1,6
2,2	0,45	1,713	1,838	1,75
2,3	0,4	1,867	1,979	1,9
2,5	0,45	2,013	2,138	2,05
2,6	0,45	2,113	2,238	2,15
3	0,5	2,459	2,599	2,5
3,5	0,6	2,850	3,010	2,9
4	0,7	3,242	3,422	3,3
4,5	0,75	3,688	3,878	3,7
5	0,8	4,134	4,334	4,2
5,5	0,9	4,526	4,750	4,6
6	1	4,917	5,153	5
7	1	5,917	6,153	6
8	1,25	6,647	6,912	6,8
9	1,25	7,647	7,912	7,8
10	1,5	8,376	8,676	8,5
11	1,5	9,376	9,676	9,5
12	1,75	10,106	10,441	10,2
14	2	11,835	12,210	12
16	2	13,835	14,210	14
18	2,5	15,294	15,744	15,5
20	2,5	17,294	17,744	17,5
22	2,5	19,294	19,744	19,5
24	3	20,752	21,252	21
27	3	23,752	24,252	24
30	3,5	26,211	26,771	26,5
33	3,5	29,211	29,771	29,5
36	4	31,670	32,270	32
39	4	34,670	35,270	35
42	4,5	37,129	37,799	37,5
45	4,5	40,129	40,799	40,5
48	5	42,587	43,297	43
52	5	46,587	47,297	47
56	5,5	50,046	50,796	50,5
60	5,5	54,046	54,796	54,5
64	6	57,505	58,305	58
68	6	61,505	62,305	62

MF ISO Metric fine thread DIN 13

Nom. size		D ₁ (6H)			Nom. size		D ₁ (6H)		
D mm	x P mm	min. mm	max. mm		D mm	x P mm	min. mm	max. mm	
M 2,5 x 0,35	2,121	2,221	2,15	M 35 x 1,5	33,376	33,676	33,5		
2,6 x 0,35	2,221	2,321	2,25	36 x 1,5	34,376	34,676	34,5		
3 x 0,35	2,621	2,721	2,65	36 x 2	33,835	34,210	34		
3,5 x 0,35	3,121	3,221	3,15	36 x 3	32,752	33,252	33		
4 x 0,35	3,621	3,721	3,65	38 x 1,5	36,376	36,676	36,5		
4 x 0,5	3,459	3,599	3,5	39 x 1,5	37,376	37,676	37,5		
5 x 0,5	4,459	4,599	4,5	39 x 2	36,835	37,210	37		
6 x 0,5	5,459	5,599	5,5	39 x 3	35,752	36,252	36		
6 x 0,75	5,188	5,378	5,2	40 x 1,5	38,376	38,676	38,5		
7 x 0,75	6,188	6,378	6,2	40 x 2	37,835	38,210	38		
8 x 0,75	7,188	7,378	7,2	42 x 1,5	40,376	40,676	40,5		
8 x 1	6,917	7,153	7	42 x 2	39,835	40,210	40		
9 x 0,75	8,188	8,378	8,2	42 x 3	38,752	39,252	39		
9 x 1	7,917	8,153	8	45 x 1,5	43,376	43,676	43,5		
10 x 0,75	9,188	9,378	9,2	45 x 2	42,835	43,210	43		
10 x 1	8,917	9,153	9	45 x 3	41,752	42,252	42		
10 x 1,25	8,647	8,912	8,8	48 x 1,5	46,376	46,676	46,5		
11 x 1	9,917	10,153	10	48 x 2	45,835	46,210	46		
12 x 1	10,917	11,153	11	48 x 3	44,752	45,252	45		
12 x 1,25	10,647	10,912	10,8	50 x 1,5	48,376	48,676	48,5		
12 x 1,5	10,376	10,676	10,5	50 x 2	47,835	48,210	48		
14 x 1	12,917	13,153	13	52 x 1,5	50,376	50,676	50,5		
14 x 1,25	12,647	12,912	12,8	52 x 2	49,835	50,210	50		
14 x 1,5	12,376	12,676	12,5	52 x 3	48,752	49,252	49		
15 x 1	13,917	14,153	14	56 x 3	52,752	53,252	53		
16 x 1	14,917	15,153	15	56 x 4	51,670	52,270	52		
16 x 1,5	14,376	14,676	14,5	60 x 4	55,670	56,270	56		
18 x 1	16,917	17,153	17	64 x 3	60,752	61,252	61		
18 x 1,5	16,376	16,676	16,5	64 x 4	59,670	60,270	60		
18 x 2	15,835	16,210	16	68 x 4	63,670	64,270	64		
20 x 1	18,917	19,153	19	70 x 3	66,752	67,252	67		
20 x 1,5	18,376	18,676	18,5	70 x 4	65,670	66,270	66		
20 x 2	17,835	18,210	18	72 x 3	68,752	69,252	69		
22 x 1	20,917	21,153	21	72 x 4	67,670	68,270	68		
22 x 1,5	20,376	20,676	20,5	72 x 6	65,505	66,305	66		
22 x 2	19,835	20,210	20	76 x 3	72,752	73,252	73		
24 x 1	22,917	23,153	23	76 x 4	71,670	72,270	72		
24 x 1,5	22,376	22,676	22,5	76 x 6	69,505	70,305	70		
24 x 2	21,835	22,210	22	80 x 4	75,670	76,270	76		
25 x 1,5	23,376	23,676	23,5	80 x 6	73,505	74,305	74		
26 x 1,5	24,376	24,676	24,5	85 x 3	81,752	82,252	82		
27 x 1,5	25,376	25,676	25,5	85 x 4	80,670	81,270	81		
27 x 2	24,835	25,210	25	90 x 3	86,752	87,252	87		
28 x 1,5	26,376	26,676	26,5	90 x 4	85,670	86,270	86		
28 x 2	25,835	26,210	26	90 x 6	83,505	84,305	84		
30 x 1,5	28,376	28,676	28,5	95 x 6	88,505	89,305	89		
30 x 2	27,835	28,210	28	100 x 4	95,670	96,270	96		
32 x 1,5	30,376	30,676	30,5	100 x 6	93,505	94,305	94		
32 x 2	29,835	30,210	30	110 x 6	103,505	104,305	104		
33 x 1,5	31,376	31,676	31,5	115 x 3	111,752	112,252	112		
33 x 2	30,835	31,210	31	120 x 4	115,670	116,270	116		
34 x 1,5	32,376	32,676	32,5	120 x 6	113,505	114,305	114		

11.2. Thread Hole Preparatory Diameters

Unified Threads

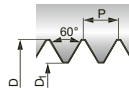

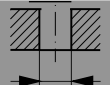
UNC Unified coarse thread ANSI/ASME B1.1

Nom. size D - Gg/1" inch - (tpi)	D ₁ (2B)		 mm
	min. mm	max. mm	
Nr. 1 - 64	1,425	1,582	1,55
Nr. 2 - 56	1,694	1,872	1,85
Nr. 3 - 48	1,941	2,146	2,1
Nr. 4 - 40	2,156	2,385	2,35
Nr. 5 - 40	2,487	2,697	2,65
Nr. 6 - 32	2,647	2,896	2,85
Nr. 8 - 32	3,307	3,528	3,5
Nr. 10 - 24	3,680	3,949	3,9
Nr. 12 - 24	4,341	4,590	4,5
1/4 - 20	4,976	5,268	5,1
5/16 - 18	6,411	6,734	6,6
3/8 - 16	7,805	8,164	8
7/16 - 14	9,149	9,550	9,4
1/2 - 13	10,584	11,016	10,8
9/16 - 12	11,996	12,456	12,2
5/8 - 11	13,376	13,868	13,5
3/4 - 10	16,299	16,833	16,5
7/8 - 9	19,169	19,748	19,5
1" - 8	21,963	22,598	22,25
1 1/8 - 7	24,648	25,349	25
1 1/4 - 7	27,823	28,524	28
1 3/8 - 6	30,343	31,120	30,75
1 1/2 - 6	33,518	34,295	34
1 3/4 - 5	38,951	39,814	39,5
2" - 4 1/2	44,689	45,598	45

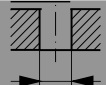
UNF Unified fine thread ANSI/ASME B1.1

Nom. size D - Gg/1" inch - (tpi)	D ₁ (2B)		 mm
	min. mm	max. mm	
Nr. 2 - 64	1,755	1,913	1,85
Nr. 3 - 56	2,024	2,197	2,15
Nr. 4 - 48	2,271	2,459	2,4
Nr. 5 - 44	2,550	2,741	2,7
Nr. 6 - 40	2,817	3,012	2,95
Nr. 8 - 36	3,401	3,597	3,5
Nr. 10 - 32	3,967	4,168	4,1
Nr. 12 - 28	4,503	4,716	4,6
1/4 - 28	5,367	5,580	5,5
5/16 - 24	6,792	7,038	6,9
3/8 - 24	8,379	8,626	8,5
7/16 - 20	9,738	10,030	9,9
1/2 - 20	11,326	11,618	11,5
9/16 - 18	12,761	13,084	12,9
5/8 - 18	14,348	14,671	14,5
3/4 - 16	17,330	17,689	17,5
7/8 - 14	20,262	20,663	20,4
1" - 12	23,109	23,569	23,25
1 1/8 - 12	26,284	26,744	26,5
1 1/4 - 12	29,459	29,919	29,5
1 3/8 - 12	32,634	33,094	32,75
1 1/2 - 12	35,809	36,269	36

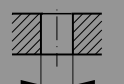
UN-8

Nom. size D - Gg/1" inch - (tpi)	D ₁ (2B)		 mm
	min. mm	max. mm	
1 1/8 - 8	25,138	25,773	25,4
1 1/4 - 8	28,313	28,948	28,6
1 1/2 - 8	34,663	35,298	35
1 3/4 - 8	41,013	41,648	41,3
2" - 8	47,363	47,998	47,7

UNEF

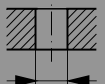
Nom. size D - Gg/1" inch - (tpi)	D ₁ (2B)		 mm
	min. mm	max. mm	
1/4 - 32	5,491	5,679	5,55
5/16 - 32	7,079	7,267	7,15
3/8 - 32	8,666	8,854	8,7
7/16 - 28	10,130	10,343	10,2
1/2 - 28	11,717	11,930	11,8
9/16 - 24	13,142	13,388	13,2
5/8 - 24	14,729	14,975	14,8
3/4 - 20	17,676	17,968	17,8
7/8 - 20	20,851	21,143	20,95
1" - 20	24,026	24,318	24,15

Cylindrical PipeThreads

G

Whitworth pipe thread DIN EN ISO 228

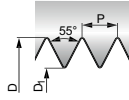

Nom. size D - P/1" (tpi)	D ₁		 mm
	min. mm	max. mm	
G 1/16 - 28	6,561	6,843	6,8
1/8 - 28	8,566	8,848	8,8
1/4 - 19	11,445	11,890	11,8
3/8 - 19	14,950	15,395	15,25
1/2 - 14	18,631	19,172	19
5/8 - 14	20,587	21,128	21
3/4 - 14	24,117	24,658	24,5
7/8 - 14	27,877	28,418	28,25
1" - 11	30,291	30,931	30,75
1 1/8 - 11	34,939	35,579	35,5
1 1/4 - 11	38,952	39,592	39,5
1 3/8 - 11	41,365	42,005	41,75
1 1/2 - 11	44,845	45,485	45,25
1 5/8 - 11	49,030	49,670	49,5
1 3/4 - 11	50,788	51,428	51
2" - 11	56,656	57,296	57
2 1/4 - 11	62,752	63,392	63,3
2 1/2 - 11	72,226	72,866	72,8
2 3/4 - 11	78,576	79,216	79,1
3" - 11	84,926	85,566	85,5

NPSM

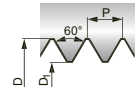
 American Standard straight pipe thread
ANSI/ASME B1.20.1
for mechanical joints (previously NPS)

Nom. size D - P/1" inch (tpi)	D ₁		 mm
	min. mm	max. mm	
1/8 - 27	9,093	9,246	9,1
1/4 - 18	11,887	12,217	12
3/8 - 18	15,316	15,545	15,5
1/2 - 14	18,974	19,279	19
3/4 - 14	24,333	24,638	24,5
1" - 11 1/2	30,505	30,759	30,5

 American Standard straight pipe thread
ANSI B1.20.3
dryseal internal straight pipe thread for fuel,
combined with external tapered pipe thread NPTF
or PTF-SAE-SHORT; Gauge with tapered gauges

NPSF

Nom. size D - P/1" inch (tpi)	D ₁		 mm
	min. mm	max. mm	
1/16 - 27	6,304	6,393	6,35
1/8 - 27	8,651	8,740	8,7
1/4 - 18	11,232	11,364	11,3
3/8 - 18	14,671	14,803	14,75
1/2 - 14	18,118	18,288	18,2
3/4 - 14	23,465	23,635	23,5
1" - 11 1/2	29,464	29,670	29,5

Rp(BSPP)

 Cylindrical Whitworth pipe thread DIN EN 10226-1 and ISO 7-1
where pressure-tight joints are made on the threads

Nom. size D - P/1" (tpi)	D ₁		 mm
	min. mm	max. mm	
Rp1/16 - 28	6,490	6,632	6,55
1/8 - 28	8,495	8,637	8,6
1/4 - 19	11,341	11,549	11,5
3/8 - 19	14,846	15,054	15
1/2 - 14	18,489	18,773	18,5
3/4 - 14	23,975	24,259	24
1" - 11	30,111	30,471	30,25

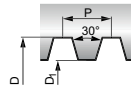

Trapezoidal and Round Threads
Tr ISO Metric trapezoidal coarse thread DIN 103

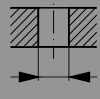
Nom. size	D ₁ (7H)		
	D	P	
D x P	min. mm	max. mm	mm
Tr 8 x 1,5	6,5	6,69	6,6
9 x 2	7	7,236	7,2
10 x 2	8	8,236	8,2
10 x 3	7	7,315	7,25
11 x 3	8	8,315	8,25
12 x 3	9	9,315	9,25
14 x 3	11	11,315	11,25
14 x 4	10	10,375	10,25
16 x 4	12	12,375	12,25
18 x 4	14	14,375	14,25
20 x 4	16	16,375	16,25
22 x 5	17	17,45	17,25
24 x 5	19	19,45	19,25
26 x 5	21	21,45	21,25
28 x 5	23	23,45	23,25
30 x 6	24	24,5	24,25
32 x 6	26	26,5	26,25
34 x 6	28	28,5	28,25
36 x 6	30	30,5	30,25
38 x 7	31	31,56	31,5
40 x 7	33	33,56	33,5
42 x 7	35	35,56	35,5
44 x 7	37	37,56	37,5
46 x 8	38	38,63	38,5
48 x 8	40	40,63	40,5
50 x 8	42	42,63	42,5
52 x 8	44	44,63	44,5

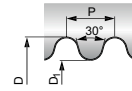
Rd Round thread DIN 405

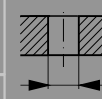
Nom. size	D ₁ (7H)		
	D	P	
D x P	min. mm	max. mm	mm
Rd 8 x 10	5,714	6,164	6
9 x 10	6,714	7,164	7
10 x 10	7,714	8,164	8
11 x 10	8,714	9,164	9
12 x 10	9,714	10,164	10
14 x 8	11,142	11,672	11,5
16 x 8	13,142	13,672	13,5
18 x 8	15,142	15,672	15,5
20 x 8	17,142	17,672	17,5
22 x 8	19,142	19,672	19,5
24 x 8	21,142	21,672	21,5
26 x 8	23,142	23,672	23,5
28 x 8	25,142	25,672	25,5
30 x 8	27,142	27,672	27,5

BSF

Nom. size	D ₁		
	D	P	
D - P	min. mm	max. mm	mm
BSF 3/16 - 32	3,747	4,006	4
1/4 - 26	5,100	5,398	5,3
5/16 - 22	6,459	6,817	6,8
3/8 - 20	7,899	8,331	8,3
7/16 - 18	9,304	9,764	9,7
1/2 - 16	10,668	11,163	11,1
5/8 - 14	13,553	14,094	14
3/4 - 12	16,337	16,939	16,75
7/8 - 11	19,268	19,909	19,75
1" - 10	22,149	22,835	22,75

BSW

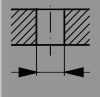
Nom. size	D ₁		
	D	P	
D - P	min. mm	max. mm	mm
BSW 1/16 - 60	1,045	1,230	1,15
3/32 - 48	1,704	1,912	1,85
1/8 - 40	2,362	2,591	2,55
5/32 - 32	2,952	3,214	3,2
3/16 - 24	3,406	3,744	3,7
7/32 - 24	4,201	4,539	4,5
1/4 - 20	4,724	5,156	5,1
5/16 - 18	6,129	6,589	6,5
3/8 - 16	7,493	7,988	7,9
7/16 - 14	8,791	9,332	9,25
1/2 - 12	9,987	10,589	10,5
9/16 - 12	11,575	12,177	12
5/8 - 11	12,918	13,559	13,5
3/4 - 10	15,799	16,485	16,4
7/8 - 9	18,613	19,355	19,25
1" - 8	21,336	22,149	22
1 1/8 - 7	23,927	24,831	24,75
1 1/4 - 7	27,102	28,006	27,75
1 3/8 - 6	29,504	30,528	30,5
1 1/2 - 6	32,680	33,703	33,5
1 5/8 - 5	34,769	35,963	35,5
1 3/4 - 5	37,943	39,136	39
1 7/8 - 4 1/2	40,396	41,702	41,5
2" - 4 1/2	43,571	44,877	44,5

Drill cylindrically
without using a reamer

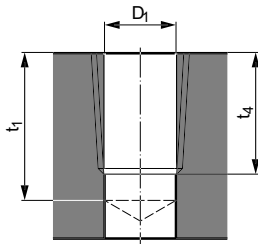

Drill cylindrically and prepare
tapered hole with reamer

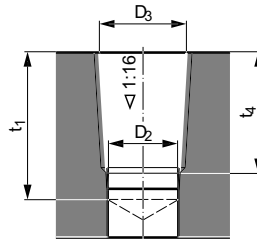

Recommended preparation
of blind holes (minimum length)

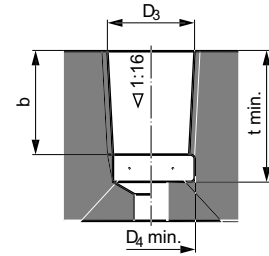

Rc (BSPT)

Tapered Whitworth pipe thread DIN EN 10226-2 and ISO 7-1 where pressure-tight joints are made on the threads, taper 1:16

Nom. size	D ₁	t ₁	t ₂
D - P/1" (tpi)	mm	mm	mm
Rc1/16 - 28	6,15	11,1	9,5
1/8 - 28	8,15	11,1	9,5
1/4 - 19	10,85	16,3	14
3/8 - 19	14,3	16,7	14,4
1/2 - 14	17,8	22,3	19,1
3/4 - 14	23,2	23,6	20,4
1" - 11	29,2	28,3	24,3

Nom. size	D ₂	D ₃ (JS11)	t ₁	t ₂
D - P/1" (tpi)	mm	mm	mm	mm
Rc1/16 - 28	6,1	6,56	11,1	9,5
1/8 - 28	8,1	8,57	11,1	9,5
1/4 - 19	10,75	11,45	16,3	14
3/8 - 19	14,25	14,95	16,7	14,4
1/2 - 14	17,7	18,63	22,3	19,1
3/4 - 14	23,1	24,12	23,6	20,4
1" - 11	29,1	30,29	28,3	24,3

Nom. size	D ₃ (JS11)	b	t min.	D ₄ min.
D - P/1" (tpi)	mm	mm	mm	mm
Rc1/16 - 28	6,56	5,6	9,9	7,6 ^{+0,3}
1/8 - 28	8,57	5,6	9,9	9,6 ^{+0,3}
1/4 - 19	11,45	8,4	14,6	13 ^{+0,5}
3/8 - 19	14,95	8,8	15	16,5 ^{+0,5}
1/2 - 14	18,63	11,4	20	20,6 ^{+0,5}
3/4 - 14	24,12	12,7	21,3	26 ^{+0,5}
1" - 11	30,29	14,5	25,4	32,8 ^{+0,5}

NPT

American tapered pipe thread ANSI/ASME B1.20.1 for threads with dryseal material taper 1:16

Nom. size	D ₁	t ₁	t ₂
D - P/1" (tpi)	mm	mm	mm
1/16 - 27	6,15	11,8	9,7
1/8 - 27	8,5	11,9	9,75
1/4 - 18	11	17,4	14,25
3/8 - 18	14,4	17,7	14,55
1/2 - 14	17,8	23,1	19
3/4 - 14	23,15	23,6	19,5
1" - 11 1/2	29,05	28,4	23,4
1 1/4 - 11 1/2	37,8	28,9	23,9
1 1/2 - 11 1/2	43,85	28,9	23,9
2" - 11 1/2	55,85	29,3	24,35

Nom. size	D ₂	D ₃ +0,05	t ₁	t ₂
D - P/1" (tpi)	mm	mm	mm	mm
1/16 - 27	5,95	6,39	11,8	9,7
1/8 - 27	8,3	8,74	11,9	9,75
1/4 - 18	10,75	11,36	17,4	14,25
3/8 - 18	14,15	14,8	17,7	14,55
1/2 - 14	17,45	18,32	23,1	19
3/4 - 14	22,8	23,67	23,6	19,5
1" - 11 1/2	28,65	29,69	28,4	23,4
1 1/4 - 11 1/2	37,35	38,45	28,9	23,9
1 1/2 - 11 1/2	43,45	44,52	28,9	23,9
2" - 11 1/2	55,45	56,56	29,3	24,35

Nom. size	D ₃ +0,05	b	t min.	D ₄ min.
D - P/1" (tpi)	mm	mm	mm	mm
1/16 - 27	6,39	7	10	7,6
1/8 - 27	8,74	7	10	10
1/4 - 18	11,36	10,2	14,5	13,1
3/8 - 18	14,8	10,6	15	16,5
1/2 - 14	18,32	13,8	19	20,5
3/4 - 14	23,67	14,2	20	25,8
1" - 11 1/2	29,69	17	24	32,2
1 1/4 - 11 1/2	38,45	17,5	24,5	41
1 1/2 - 11 1/2	44,52	17,5	24,5	47,2
2" - 11 1/2	56,56	18	25	59,2

NPTF

American tapered pipe thread ANSI B1.20.3 for threads without dryseal material taper 1:16

Nom. size	D ₁	t ₁	t ₂
D - P/1" (tpi)	mm	mm	mm
1/16 - 27	6,1	13	10,65
1/8 - 27	8,45	13	10,7
1/4 - 18	10,9	19,2	15,65
3/8 - 18	14,3	19,5	16
1/2 - 14	17,6	25,4	20,85
3/4 - 14	23	25,9	21,3
1" - 11 1/2	28,75	31,1	25,6
1 1/4 - 11 1/2	37,5	31,7	26,15
1 1/2 - 11 1/2	43,75	31,7	26,15
2" - 11 1/2	55,75	32,1	26,55

Nom. size	D ₂	D ₃ +0,05	t ₁	t ₂
D - P/1" (tpi)	mm	mm	mm	mm
1/16 - 27	5,95	6,41	13	10,65
1/8 - 27	8,3	8,76	13	10,7
1/4 - 18	10,75	11,4	19,2	15,65
3/8 - 18	14,15	14,84	19,5	16
1/2 - 14	17,45	18,33	25,4	20,85
3/4 - 14	22,8	23,68	25,9	21,3
1" - 11 1/2	28,65	29,72	31,1	25,6
1 1/4 - 11 1/2	37,35	38,48	31,7	26,15
1 1/2 - 11 1/2	43,45	44,55	31,7	26,15
2" - 11 1/2	55,45	56,59	32,1	26,55

Nom. size	D ₃ +0,05	b	t min.	D ₄ min.
D - P/1" (tpi)	mm	mm	mm	mm
1/16 - 27	6,41	8	11	7,4
1/8 - 27	8,76	8	11	9,8
1/4 - 18	11,4	11,6	15,5	12,9
3/8 - 18	14,84	12	16	16,3
1/2 - 14	18,33	15,6	20,5	20,3
3/4 - 14	23,68	16	21,5	25,6
1" - 11 1/2	29,72	19,2	26	32
1 1/4 - 11 1/2	38,48	19,7	26,5	40,8
1 1/2 - 11 1/2	44,55	19,7	26,5	47
2" - 11 1/2	56,59	20,2	27	59

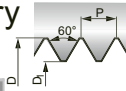
Threads for the Aerospace Industry
MJ MJ thread DIN ISO 5855

Nom. size	D ₁			
	D x P mm mm	min. mm	max. mm	
MJ 3 x 0,5	2,513	2,653	2,6	
4 x 0,7	3,318	3,498	3,4	
5 x 0,8	4,221	4,421	4,3	
6 x 1	5,026	5,216	5,1	
8 x 1	7,026	7,216	7,1	
8 x 1,25	6,782	6,994	6,9	
10 x 1,25	8,782	8,994	8,9	
10 x 1,5	8,539	8,775	8,6	

UNJF Unified fine thread ASME B1.15

Nom. size	D ₁			
	D - P/1" inch (tpi)	min. mm	max. mm	
Nr. 4 - 48	2,329	2,466	2,4	
Nr. 6 - 40	2,888	3,053	3	
Nr. 8 - 36	3,480	3,663	3,55	
Nr. 10 - 32	4,054	4,255	4,15	
1/4 - 28	5,466	5,662	5,55	
5/16 - 24	6,906	7,109	7	
3/8 - 24	8,494	8,679	8,6	

UNJC Unified coarse thread ASME B1.15

Nom. size	D ₁			
	D - P/1" inch (tpi)	min. mm	max. mm	
Nr. 4 - 40	2,228	2,393	2,3	
Nr. 6 - 32	2,733	2,939	2,85	
Nr. 8 - 32	3,393	3,599	3,5	
Nr. 10 - 24	3,795	4,064	3,9	
1/4 - 20	5,113	5,387	5,25	
5/16 - 18	6,563	6,833	6,7	
3/8 - 16	7,978	8,255	8,1	

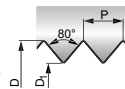
Steel Conduit Threads
Pg Steel conduit thread DIN 40430

Nom. size	D ₁			
	D mm	P/1" (tpi)	min. mm	
Pg 7	20	11,28	11,43	
9	18	13,86	14,01	
11	18	17,26	17,41	
13,5	18	19,06	19,21	
16	18	21,16	21,31	
21	16	26,78	27,03	
29	16	35,48	35,73	
36	16	45,48	45,73	
42	16	52,48	52,73	
48	16	57,78	58,03	

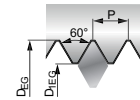
Helical Coil Threads for Wire Thread Inserts

EG M(STI) ISO Metric coarse thread DIN 8140-2

Nom. size	D _{EG}		D _{1EG}		
	D mm	P mm	min. mm	max. mm	
EG M2,5	0,45	3,084	2,597	2,697	
3	0,5	3,650	3,108	3,220	
4	0,7	4,910	4,152	4,292	
5	0,8	6,040	5,174	5,334	
6	1	7,300	6,217	6,407	
8	1,25	9,624	8,271	8,483	
10	1,5	11,948	10,324	10,560	
12	1,75	14,274	12,379	12,644	
14	2	16,598	14,433	14,733	
16	2	18,598	16,433	16,733	
18	2,5	21,248	18,541	18,896	
20	2,5	23,248	20,541	20,896	

EG UNC (STI) Unified coarse thread ASME B18.29.1

Nom. size	D _{EG}		D _{1EG}		
	D mm	P/1" (tpi)	min. mm	max. mm	
EGNr. 4 - 40	3,671	2,982	3,178	3,1	
Nr. 6 - 32	4,536	3,678	3,879	3,8	
Nr. 8 - 32	5,197	4,338	4,523	4,4	
Nr. 10 - 24	6,200	5,054	5,283	5,2	
1/4 - 20	8,002	6,628	6,872	6,7	
5/16 - 18	9,771	8,244	8,490	8,4	
3/8 - 16	11,587	9,867	10,126	10	
7/16 - 14	13,469	11,506	11,783	11,6	
1/2 - 13	15,237	13,121	13,393	13,3	
9/16 - 12	17,039	14,747	15,031	14,9	
5/8 - 11	18,875	16,376	16,673	16,5	
3/4 - 10	22,349	19,598	19,908	19,75	

EG UNF (STI) Unified coarse thread ASME B18.29.1

Nom. size	D _{EG}		D _{1EG}		
	D mm	P/1" (tpi)	min. mm	max. mm	
EGNr. 4 - 48	3,533	2,959	3,119	3	
Nr. 6 - 40	4,330	3,642	3,815	3,7	
Nr. 8 - 36	5,083	4,318	4,496	4,4	
Nr. 10 - 32	5,858	4,999	5,184	5,1	
1/4 - 28	7,528	6,545	6,720	6,6	
5/16 - 24	9,312	8,166	8,351	8,25	
3/8 - 24	10,899	9,753	9,931	9,8	
7/16 - 20	12,763	11,389	11,587	11,5	
1/2 - 20	14,352	12,978	13,176	13,1	
9/16 - 18	16,121	14,594	14,800	14,7	
5/8 - 18	17,709	16,182	16,388	16,25	
3/4 - 16	21,112	19,392	19,608	19,5	

TAPERED TREAD PROFILE EXTERNAL NPT

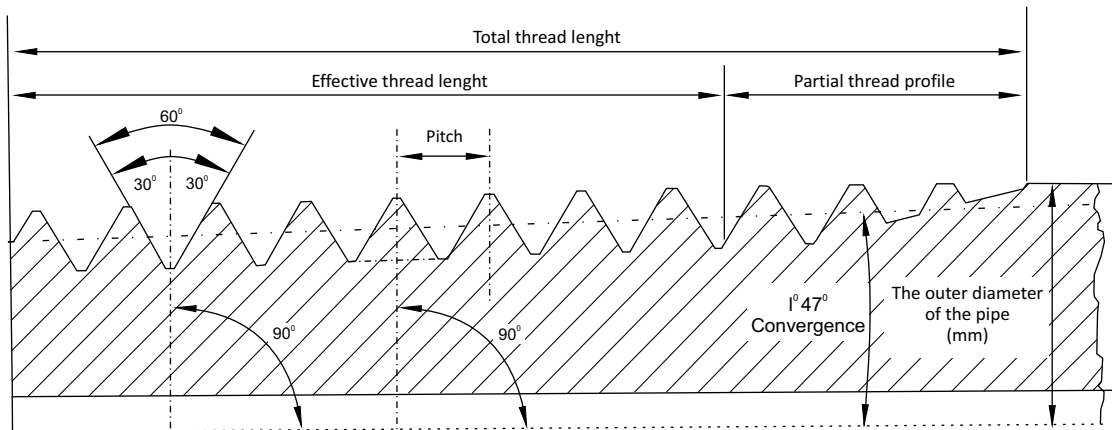

Thread diameter (inch)	Thread pitch (T.P.I.)	Outer diameter of the pipe (mm)	Total thread length (mm)
1/16	27	7,950	9,896
1/8	27	10,287	9,967
1/4	18	13,716	15,103
3/8	18	17,145	15,255
1/2	14	21,336	19,850
3/4	14	26,670	20,155
1	11.1/2	33,401	25,006
1.1/4	11.1/2	42,164	25,616
1.1/2	11.1/2	48,260	26,040
2	11.1/2	60,325	26,878
2.1/2	8	73,025	39,908
3	8	88,900	41,496
3.1/2	8	101,600	42,766
4	8	114,300	44,036

11.3. Recommended Hole Diameters for Forming Taps

M

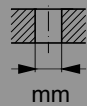
Nom. size		
D mm	P mm	
M 1	0,25	0,9
1,1	0,25	1
1,2	0,25	1,1
1,4	0,3	1,28
1,6	0,35	1,47
1,7	0,35	1,57
1,8	0,35	1,67
2	0,4	1,85
2,2	0,45	2,03
2,3	0,4	2,15
2,5	0,45	2,33
2,6	0,45	2,43
3	0,5	2,8
3,5	0,6	3,25
4	0,7	3,7
4,5	0,75	4,2
5	0,8	4,65
5,5	0,9	5,1
6	1	5,6
7	1	6,6
8	1,25	7,45
9	1,25	8,45
10	1,5	9,35
12	1,75	11,25
14	2	13,1
16	2	15,1
18	2,5	16,85
20	2,5	18,85
22	2,5	20,85
24	3	22,65
27	3	25,65
30	3,5	28,4
33	3,5	31,4
36	4	34,15
39	4	37,15
42	4,5	39,9
45	4,5	42,9
48	5	45,65

MF

Nom. size		
D mm	P mm	
M 2,5 x	0,35	2,37
2,6 x	0,35	2,47
3 x	0,35	2,88
3,5 x	0,35	3,38
4 x	0,5	3,8
5 x	0,5	4,8
6 x	0,5	5,8
6 x	0,75	5,7
7 x	0,75	6,7
8 x	0,75	7,7
8 x	1	7,6
9 x	0,75	8,7
9 x	1	8,6
10 x	0,75	9,7
10 x	1	9,6
10 x	1,25	9,45
11 x	1	10,6
12 x	1	11,6
12 x	1,25	11,45
12 x	1,5	11,35
14 x	1	13,6
14 x	1,25	13,45
14 x	1,5	13,35
15 x	1	14,6
15 x	1,5	14,35
16 x	1	15,6
16 x	1,5	15,35
18 x	1	17,6
18 x	1,5	17,35
18 x	2	17,1
20 x	1	19,6
20 x	1,5	19,35
20 x	2	19,1
24 x	2	23,1
30 x	2	29,1
36 x	3	34,65
42 x	4	40,15
48 x	3	46,65

UNC

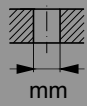
Nom. size		
D inch	P/1" (tpi)	
Nr. 4 -	40	2,55
Nr. 5 -	40	2,9
Nr. 6 -	32	3,15
Nr. 8 -	32	3,8
Nr. 10 -	24	4,35
Nr. 12 -	24	5
1/4 -	20	5,75
3/8 -	16	8,8
7/16 -	14	10,25
1/2 -	13	11,8
9/16 -	12	13,3
5/8 -	11	14,8
3/4 -	10	17,85
7/8 -	9	20,9
1" -	8	23,9

UNF

Nom. size		
D inch	P/1" (tpi)	
Nr. 2 -	64	2,02
Nr. 3 -	56	2,32
Nr. 4 -	48	2,62
Nr. 5 -	44	2,92
Nr. 6 -	40	3,22
Nr. 8 -	36	3,85
Nr. 10 -	32	4,45
Nr. 12 -	28	5,1
1/4 -	28	5,95
5/16 -	24	7,45
3/8 -	24	9,05
7/16 -	20	10,55
1/2 -	20	12,15
9/16 -	18	13,65
5/8 -	18	15,25
3/4 -	16	18,35
7/8 -	14	21,4
1" -	12	24,45

G

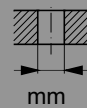
Nom. size		
D inch	P/1" (tpi)	
G 1/16 -	28	7,25
1/8 -	28	9,25
1/4 -	19	12,55
3/8 -	19	16,05
1/2 -	14	20,1
5/8 -	14	22,05
3/4 -	14	25,6
7/8 -	14	29,35
1" -	11	32,15

11.4. Formulas to calculate technological parameters for drilling and tapping

Relationships of peripheral speed and rotational speed and tool diameter

Cutting speed V_c [m/min]

$$v_c = \frac{d_1 \times \pi \times n}{1000}$$

Spindle rotation speed [RPM]

$$n = \frac{1000 \times v_c}{d_1 \times \pi}$$

Feeding speed V_f [mm/min]

- when tapping

$$v_f = p \times n$$

- when drilling

$$v_f = f_o \times n$$

$$f_o = \frac{v_f}{n}$$

Torque when tapping M_d [Nm]

$$M_d = \frac{p^2 \times d_1 \times k_c}{8000}$$

Torque when drilling M_c [Nm]

$$M_c = \frac{F_c \times z \times d_1}{4000}$$

Cutting force per one tooth F_c [N]

$$F_c = \frac{d_1 \times f_o \times k_c}{2}$$

Power P [kW]

$$P = \frac{M_{c,d} \times 2 \times \pi \times n}{60000}$$

Key:

d_1 - nominal diameter of tool [mm]

v_c - cutting speed [m/min]

n - spindle rotation speed [RPM]

p - thread pitch [mm]

P - power [kW]

v_f - feeding speed [m/min]

f_o - feed per revolution [RPM]

k_c - specific resistance of workpiece material [MPa]

M_d - torque when tapping [Nm]

z - cutting edges

11.5. Recommended diameter for thread cutting rods

M	
THREAD	ø d
M 1	0,96
M 1,1	1,05
M 1,2	1,15
M 1,4	1,35
M 1,6	1,55
M 1,8	1,75
M 2	1,95
M 2,2	2,15
M 2,5	2,42
M 3	2,92
M 3,5	3,41
M 4	3,90
M 4,5	4,40
M 5	4,90
M 6	5,88
M 7	6,88
M 8	7,86
M 9	8,86
M 10	9,85
M 11	10,85
M 12	11,83
M 14	13,82
M 16	15,82
M 18	17,79
M 20	19,79
M 22	21,79
M 24	23,76
M 27	26,76
M 30	29,73
M 33	32,73
M 36	35,70
M 39	38,70
M 42	41,68
M 45	44,68
M 48	47,66
M 52	51,66
M 56	55,65
M 60	59,65
M 64	63,62
M 68	67,62

MF	
THREAD	ø d
M3,5x0,5	3,43
M4x0,5	3,92
M4,5x0,5	4,43
M5x0,5	4,92
M5x0,75	4,91
M5,5x0,5	5,43
M5,5x0,75	5,42
M6x0,5	5,92
M6x0,75	5,90
M7x0,75	6,90
M8x0,5	7,92
M8x0,75	7,90
M8x1	7,88
M9x0,75	8,90
M9x1	8,88
M10x0,75	9,90
M10x1	9,88
M10x1,25	9,86
M11x0,75	10,91
M11x1	10,88
M12x1	11,88
M12x1,25	11,86
M12x1,5	11,85
M14x1	13,88
M14x1,5	13,85

MF cd.	
THREAD	ø d
M15x1	14,88
M15x1,5	14,85
M16x1	15,88
M16x1,5	15,85
M17x1	16,88
M17x1,5	16,85
M18x1	17,88
M18 x1,5	17,85
M18x2	17,82
M20x1	19,88
M20x1,5	19,85
M20x2	19,82
M22x1	21,88
M22x1,5	21,85
M22x2	21,82
M24x1	23,88
M24x1,5	23,85
M24x2	23,82
M25x1	24,88
M25x1,5	24,85
M25x2	24,82
M26x1,5	25,85
M27x1	26,88
M27x1,5	26,85
M27x2	26,82
M28x1	27,88
M28x1,5	27,85
M28x2	27,82
M30x1	29,88
M30x1,5	29,85
M30x2	29,82
M30x3	29,76
M32x1,5	31,85
M32x2	31,82
M33x1,5	32,85
M33x2	32,82
M33x3	32,76
M35x1,5	34,85
M36x1,5	35,85
M36x2	35,82
M36x3	35,76
M38x1,5	37,85
M39x1,5	38,85
M39x2	38,82
M39x3	38,76
M40x1,5	39,85
M40x2	39,82
M40x3	39,76
M42x1,5	41,85
M42x2	41,82
M42x3	41,76
M45x1,5	44,85
M45x2	44,82
M45x3	44,76
M48x1,5	47,85
M48x2	47,82
M48x3	47,76
M48x4	47,73
M50x1,5	49,85
M50x2	49,82
M50x3	49,76
M52x1,5	51,85
M52x2	51,82
M52x3	51,76
M52x4	51,73
M55x1,5	54,85
M55x2	54,82
M55x3	54,76
M55x4	54,73
M56x1,5	55,85
M56x2	55,82
M56x3	55,76
M56x4	55,73

G	
THREAD	ø d
G - 1/8"	9,62
G - 1/4"	13,03
G - 3/8"	16,54
G - 1/2"	20,81
G - 5/8"	22,77
G - 3/4"	26,30
G - 7/8"	30,06
G - 1"	33,07
G - 1.1/8"	37,72
G - 1.1/4"	41,73
G - 1.3/8"	44,14
G - 1.1/2"	47,62
G - 1.3/4"	53,57
G - 2"	59,43
G - 2.1/4"	65,49

BSW	
THREAD	ø d
1/8 - 40	3,09
3/16 - 24	4,66
1/4 - 20	6,24
5/16 - 18	7,82
3/8 - 16	9,40
7/16 - 14	10,98
1/2 - 12	12,56
9/16 - 12	14,14
5/8 - 11	15,72
3/4 - 10	18,89
7/8 - 9	22,10
1 - 8	25,27

NPT	
THREAD	ø d
1/8"	9,99
1/4"	13,26
3/8"	16,67
1/2"	20,71
3/4"	26,03
1"	32,59

UNC	
THREAD	ø d
No 5 - 40	3,09
No 6 - 32	3,41
No 8 - 32	4,07
No 10 - 24	4,71
No 12 - 24	5,37
1/4 - 20	6,22
5/16 - 18	7,80
3/8 - 16	9,37
7/16 - 14	10,95
1/2 - 13	12,52
9/16 - 12	14,10
5/8 - 11	15,68
3/4 - 10	18,84
7/8 - 9	22,00
1 - 8	25,16
1.1/8 - 7	28,31
1.1/4 - 7	31,49
1.3/8 - 6	34,63
1.1/2 - 6	37,80
1.3/4 - 5	44,12
2 - 4.1/2	50,45

UNF	
THREAD	ø d
No 5 - 44	3,10
No 6 - 40	3,42
No 8 - 36	4,08
No 10 - 32	4,73
No 12 - 28	5,38
1/4 - 28	6,24
5/16 - 24	7,82
3/8 - 24	9,41
7/16 - 20	10,98
1/2 - 20	12,56
9/16 - 18	14,14
5/8 - 18	15,73
3/4 - 16	18,89
7/8 - 14	22,05
1 - 12	25,21
1.1/8 - 12	28,38
1.1/4 - 12	31,55
1.3/8 - 12	34,73
1.1/2 - 12	37,90

R	
THREAD	ø d
R - 1/8"	9,48
R - 1/4"	12,78
R - 3/8"	16,26
R - 1/2"	20,44
R - 3/4"	25,85
R - 1"	32,60

BSF	
THREAD	ø d
3/16 - 32	4,76
1/4 - 26	6,25
5/16 - 22	7,83
3/8 - 20	9,41
7/16 - 18	10,99
1/2 - 16	12,57
9/16 - 16	14,16
5/8 - 14	15,73
3/4 - 12	18,89
7/8 - 11	22,11
1 - 10	25,28

Pg	
THREAD	ø d
Pg 7	12,40
Pg 9	15,10
Pg 11	18,50
Pg 13,5	20,30
Pg 16	22,40
Pg 21	28,15
Pg 29	36,85
Pg 36	46,85
Pg 42	53,85
Pg 48	59,15

11.6. Relationships of peripheral speed and rotational speed and tool diameter

Ød ₁ [mm]	$V = \pi \cdot d_1 n / 1000$ [m/min]														
	2	3	4	5	6	8	10	12	15	18	20	25	30	35	40
3	212	318	424	531	637	849	1061	1273	1592	1910	2122	2653	3183	3714	4244
3,5	182	273	364	455	546	728	909	1091	1364	1637	1819	2274	2728	3183	3638
4	159	239	318	398	477	637	796	955	1194	1432	1592	1989	2387	2785	3183
4,5	141	212	283	354	424	566	707	849	1061	1273	1415	1768	2122	2476	2829
5	127	191	255	318	382	509	637	764	955	1146	1273	1592	1910	2228	2546
6	106	159	212	265	318	424	531	637	796	955	1061	1326	1592	1857	2122
7	91	136	182	227	273	364	455	546	682	819	909	1137	1364	1592	1819
8	80	119	159	199	239	318	398	477	597	716	796	995	1194	1393	1592
9	71	106	141	177	212	283	354	424	531	673	707	884	1061	1238	1415
10	64	95	127	159	191	255	318	382	477	573	637	796	955	1114	1273
11	58	87	116	145	174	231	289	347	434	521	579	723	868	1013	1157
12	53	80	106	133	159	212	265	318	398	477	531	663	796	928	1061
14	45	68	91	114	136	182	227	273	341	409	455	568	682	796	909
16	40	60	80	99	119	159	199	239	298	358	398	497	597	696	796
18	35	53	71	88	106	141	177	212	265	318	354	442	531	619	707
20	32	48	64	80	95	127	159	191	239	286	318	398	477	557	637
22	29	43	58	72	87	116	145	174	217	260	289	362	434	506	579
24	27	40	53	66	80	106	133	159	199	239	265	332	398	464	531
27	24	35	47	59	71	94	118	141	177	212	236	295	354	413	472
30	21	32	42	53	64	85	106	127	159	191	212	265	318	371	424
33	19	29	39	48	58	77	96	116	145	174	193	241	289	338	386
36	18	27	35	44	53	71	88	106	133	159	177	221	265	309	354
39	16	24	33	41	49	65	82	98	122	147	163	204	245	286	326
42	15	23	30	38	45	61	76	91	114	136	152	189	227	265	303
45	14	21	28	35	42	57	71	85	106	127	141	177	212	248	283
48	13	20	27	33	40	53	66	80	99	119	133	166	199	232	265
52	12	18	24	31	37	49	61	73	92	110	122	153	184	214	245

Relationships of resistances Rm, HRC, HB, HV 10

Rm [MPa]	HRC	HB	HV 10	Rm [MPa]	HRC	HB	HV 10	Rm [MPa]	HRC	HB	HV 10
240		71	75	690		204	215	1360	43	402	423
255		76	80	705		209	220	1400	44	413	434
270		81	85	720		214	225	1440	45	424	446
285		86	90	740		219	230	1480	46	435	458
305		90	95	755		223	235	1530	47	449	473
320		95	100	770		228	240	1570	48	460	484
335		100	105	785		233	245	1620	49	472	497
350		105	110	800	22	238	250	1680	50	488	514
370		109	115	820	23	242	255	1730	51	501	527
385		114	120	835	24	247	260	1890	52	517	544
400		119	125	860	25	255	268	1845	53	532	560
415		124	130	870	26	258	272	1910	54	549	578
430		128	135	900	27	266	280	1980	55	567	596
450		133	140	920	28	273	287	2050	56	584	615
465		138	145	940	29	278	293	2140	57	607	639
480		143	150	970	30	287	302		58	622	655
495		147	155	995	31	295	310		59		675
510		152	160	1020	32	301	317		60		698
530		157	165	1050	33	311	327		61		720
545		162	170	1080	34	319	336		62		745
560		166	175	1110	35	328	345		63		773
575		171	180	1140	36	337	355		64		800
595		176	185	1170	37	346	364		65		829
610		181	190	1200	38	354	373		66		864
625		185	195	1230	39	363	382		67		900
640		190	200	1260	40	372	392		68		940
660		195	205	1300	41	383	403				
675		199	210	1330	42	393	413				

11.7. Limit dimensions of pitch diameter - internal thread
ISO metric thread

Nominal size		6H		6G	
M	MF	min	max	min	max
M 2		1,740	1,830	1,759	1,849
M 2,2		1,908	2,003	1,928	2,023
M 2,5		2,208	2,303	2,228	2,323
M 3		2,675	2,775	2,695	2,795
M 3,5		3,110	3,222	3,131	3,243
M 4		3,545	3,663	3,567	3,685
	M 4x0,5	3,675	3,775	3,695	3,795
M 4,5		4,013	4,131	4,035	4,153
M 5		4,480	4,605	4,504	4,629
	M 5x0,5	4,675	4,775	4,695	4,795
M 6		5,350	5,500	5,376	5,526
	M 6x0,75	5,513	5,645	5,535	5,667
M 7		6,350	6,500	6,376	6,526
M 8		7,188	7,348	7,216	7,376
	M 8x0,75	7,513	7,645	7,535	7,667
	M 8x1	7,350	7,500	7,376	7,526
M 9		8,188	8,348	8,216	8,376
M 10		9,026	9,206	9,058	9,238
	M 10x0,75	9,513	9,645	9,535	9,667
	M 10x1	9,350	9,500	9,376	9,526
	M 10x1,25	9,188	9,348	9,216	9,376
M 12		10,863	11,063	10,897	11,097
	M 12x1	11,350	11,510	11,376	11,536
	M 12x1,25	11,188	11,368	11,216	11,396
	M 12x1,5	11,026	11,216	11,058	11,248
M 14		12,701	12,913	12,739	12,951
	M 14x1,5	13,026	13,216	13,058	13,248
M 16		14,701	14,913	14,739	14,951
	M 16x1,5	15,026	15,216	15,058	15,248
M 18		16,376	16,600	16,418	16,642
	M 18x1,5	17,026	17,216	17,058	17,248
M 20		18,376	18,600	18,418	18,642
	M 20x1,5	19,026	19,216	19,058	19,248
	M 20x2	18,701	18,913	18,739	18,951
M 22		20,376	20,600	20,418	20,642
	M 22x1,5	21,026	21,216	21,058	21,248
M 24		22,051	22,316	22,099	22,364
	M 24x1,5	23,026	23,226	23,058	23,258
	M 24x2	22,701	22,925	22,739	22,963
	M 26x1,5	25,026	25,226	25,058	25,258
M 27		25,051	25,316	25,099	25,364
	M 27x1,5	26,026	26,226	26,058	26,258
	M 27x2	25,701	25,925	25,739	25,963
	M 28x1,5	27,026	27,226	27,058	27,258
M 30		27,727	28,007	27,780	28,060
	M 30x1,5	29,026	29,226	29,058	29,258
	M 30x2	28,701	28,925	28,739	28,963
	M 32x1,5	31,026	31,226	31,058	31,258
	M 32x2	30,701	30,925	30,739	30,963
M 33		30,727	31,007	30,780	31,060
	M 33x1,5	32,026	32,226	32,058	32,258
	M 33x2	31,701	31,925	31,739	31,963
M 36		33,402	33,702	33,462	33,762
	M 36x1,5	35,026	35,226	35,058	35,258
	M 36x2	34,701	34,925	34,739	34,963
	M 36x3	34,051	34,316	34,099	34,364
M 39		36,402	36,702	36,462	36,762
	M 39x1,5	38,026	38,226	38,058	38,258
	M 39x2	37,701	37,925	37,739	37,963
	M 39x3	37,051	37,316	37,099	37,364
	M 40x1,5	39,026	39,226	39,058	39,258
M 42		39,077	39,392	39,140	39,455
	M 42x1,5	41,026	41,226	41,058	41,258
	M 42x2	40,701	40,925	40,739	40,963
	M 42x3	40,051	40,316	40,099	40,364
M 45		42,077	42,392	42,140	42,455
	M 45x1,5	44,026	44,226	44,058	44,258
	M 45x2	43,701	43,925	43,739	43,963
	M 45x3	43,051	43,316	43,099	43,364
M 48		44,752	45,087	44,823	45,158
	M 48x1,5	47,026	47,238	47,058	47,270
	M 48x2	46,701	46,937	46,739	46,975
	M 48x3	46,051	46,331	46,099	46,379
M 52		48,752	49,087	48,823	49,158
	M 52x2	50,701	50,937	50,739	50,975
	M 52x3	50,051	50,331	50,099	50,379

American unified thread UNC and UNF

Nominal size		2B / 3B	2B	3B
UNC	UNF	min	max	max
No 5 - 40		2,764	2,847	2,827
	No 5 - 44	2,799	2,880	2,860
No 6 - 32		2,990	3,084	3,058
	No 6 - 40	3,094	3,180	3,157
No 8 - 32		3,650	3,746	3,721
	No 8 - 36	3,708	3,800	3,777
No 10 - 24		4,138	4,247	4,219
	No 10 - 32	4,310	4,409	4,384
No 12 - 24		4,798	4,910	4,882
	No 12 - 28	4,897	5,004	4,976
1/4 - 20		5,524	5,648	5,616
	1/4 - 28	5,761	5,870	5,842
5/16 - 18		7,021	7,155	7,120
	5/16 - 24	7,249	7,371	7,341
3/8 - 16		8,494	8,639	8,603
	3/8 - 24	8,837	8,961	8,931
7/16 - 14		9,934	10,089	10,051
	7/16 - 20	10,287	10,424	10,391
1/2 - 13		11,430	11,595	11,552
	1/2 - 20	11,874	12,017	11,981
9/16 - 12		12,913	13,086	13,043
	9/16 - 18	13,371	13,520	13,482
5/8 - 11		14,376	14,559	14,514
	5/8 - 18	14,958	15,110	15,072
3/4 - 10		17,399	17,595	17,544
	3/4 - 16	18,019	18,184	18,143
7/8 - 9		20,391	20,599	20,546
	7/8 - 14	21,026	21,224	21,181
1 - 8		23,338	23,561	23,505
	1 - 12	24,026	24,224	24,171
1.1/8 - 7		26,218	26,457	26,398
	1.1/8 - 12	27,201	27,424	27,351
1.1/4 - 7		29,393	29,637	29,576
	1.1/4 - 12	30,376	30,619	30,528
1.3/8 - 6		32,174	32,438	32,372
	1.3/8 - 12	33,551	33,799	33,706
1.1/2 - 6		35,349	35,616	35,550
	1.1/2 - 12	36,726	36,937	36,886
1.3/4 - 5		41,151	41,445	41,372
2 - 4.1/2		47,135	47,450	47,371

Whitworth pipe thread G

Nominal size	min	max
G-1/16"	7,142	7,249
G-1/8"	9,147	9,254
G-1/4"	12,301	12,426
G-3/8"	15,806	15,931
G-1/2"	19,793	19,935
G-5/8"	21,749	21,891
G-3/4"	25,279	25,421
G-7/8"	29,039	29,181
G-1"	31,770	31,950
G-1.1/8"	36,418	36,598
G-1.1/4"	40,431	40,611
G-1.3/8"	42,844	43,024
G-1.1/2"	46,324	46,504
G-1.3/4"	52,267	52,447
G-2"	58,135	58,315

FORM OF TOOL SELECTION



FANAR fills
 Date:..... Representative:..... Inq. nr

Date:

TAP FORMING TAP

CUSTOMER'S DATA

Name and company adress:

Contact person:tel.....

1. Thread type

1.1. Size: 1.2. Tolerance:

1.3. Features and dimensions of threaded hole/bar

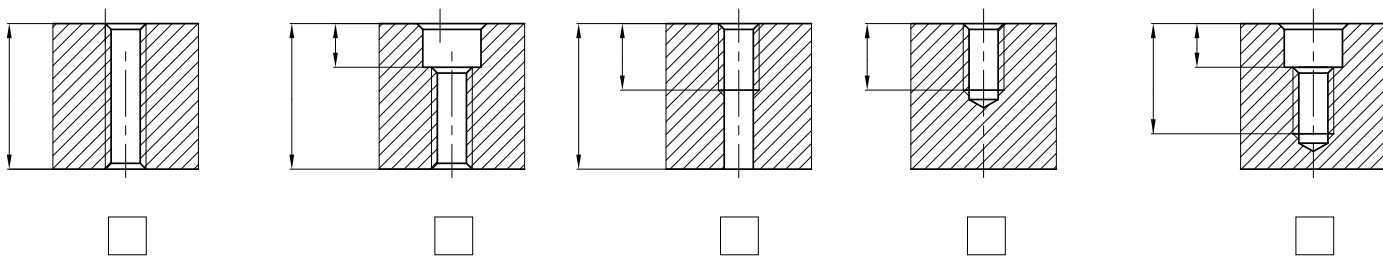

2. Threading and machine

2.1. Type of machine:

2.2. Method of threading: horizontal vertical 2.3. Forced feed: yes no

2.4. Type of holder / handle:

Axial float: yes no

Radial float: yes no

Friction clutch: yes no

2.5. Cutting speed:m/min,obr/min

2.6. Lubrification: hand auto Lubricant:

3. Working material

3.1. Type of element:

3.2. Material (symbol):

3.3. Hardness:HBHRC; Extension strength Rm.....N/mm²

3.4. Type of threaded hole/bar: Drilled Casted Reamed Other:

4. Tool

4.1. Currently used tool (type):

4.2. Service life:

4.3. Desirable dimensions:

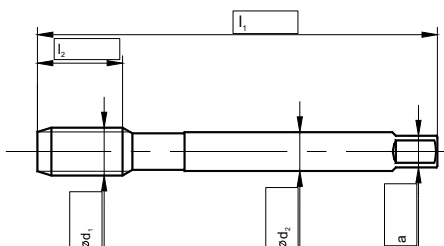

5. Notes

Suggested price:

FORM OF TOOL SELECTION



FANAR fills

Date:..... Representative:..... Inq. nr

Date:

SCREWING DIE

CUSTOMER'S DATA

Name and company adress:

Contact person:tel.....

1. Thread type

1.1. Size:

1.2. Tolerance:

1.3. Features and dimensions of threaded hole/bar

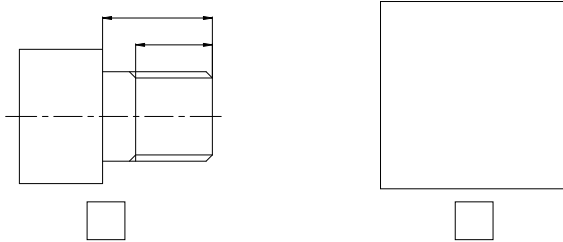

2. Threading and machine

2.1. Type of machine:

2.2. Method of threading: horizontal vertical 2.3. Forced feed: yes no

2.4. Type of holder / handle:

Axial float: yes no

Radial float: yes no

Friction clutch: yes no

2.5. Cutting speed:m/min,V.p.m

2.6. Lubrification: hand auto Lubricant:

3. Working material

3.1. Type of element:

3.2. Material (symbol):

3.3. Hardness:HBHRC; Extension strength Rm.....N/mm²

3.4. Type of threaded hole/bar: Drilled Casted Reamed Other:

4. Tool

4.1. Currently used tool (type):

4.2. Service life:

4.3. Desirable dimensions:

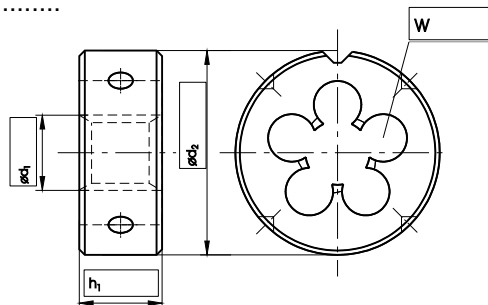

5. Notes

Suggested price:

FORM OF TOOL SELECTION



FANAR fills

Date:..... Representative:..... Inq. nr

Date:

SPECIAL DRILL

CUSTOMER'S DATA

Name and company address:

Contact person:tel.....

1. Sketch of the machined part:

1.1. Name of detail:..... 1.2. Workpiece material:.....

1.3. Hardness:

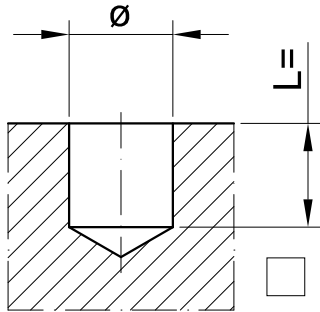

2. Tool:

2.1. Tool drawing nr:.....

2.2. Suggested material:

2.3. Suggested PVD coating:.....

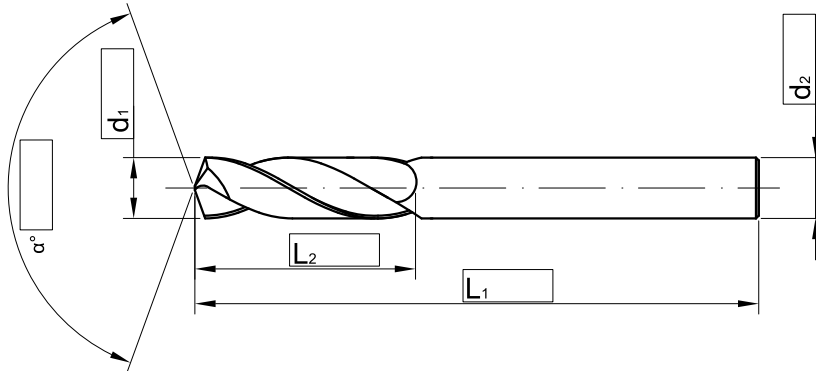

3. Execution:

3.1. Flutes: Right spiral Left spiral Straight Spiral angle:

3.2. Rotation direction: Right hand Left hand

3.3. Cooling: External Internal Non-cooling

3.4. Shank: DIN-6535-HA DIN-6535-HB DIN-65350HE

4. Machine:

4.1. Type of machine:

4.2. Type of spindle:

4.3. Power[kW]:

4.4. Max. rotating speed[RPM]:

5. Notes

Suggested price:

FORM OF TOOL SELECTION



FANAR fills

Date:..... Representative:..... Inq. nr

Date:

SPECIAL 1-STEP DRILL

CUSTOMER'S DATA

Name and company address:

Contact person:tel.....

1. Sketch of the machined part:

1.1. Name of detail:..... 1.2. Workpiece material:.....

1.3. Hardness:

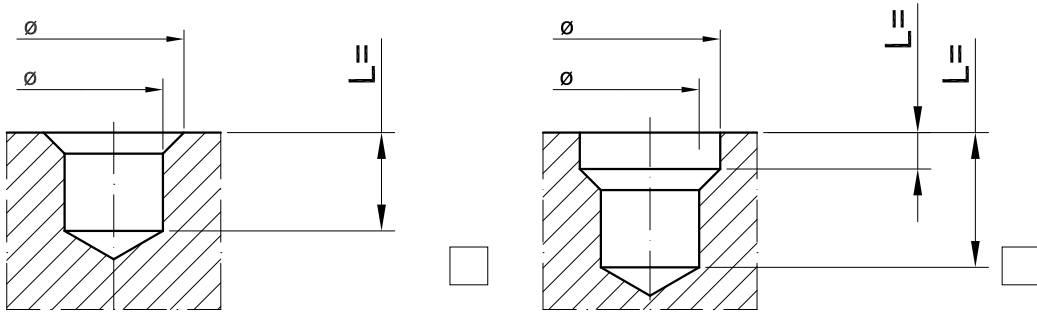

2. Tool:

2.1. Tool drawing nr:.....

2.2. Suggested material:

2.3. Suggested PVD coating:.....

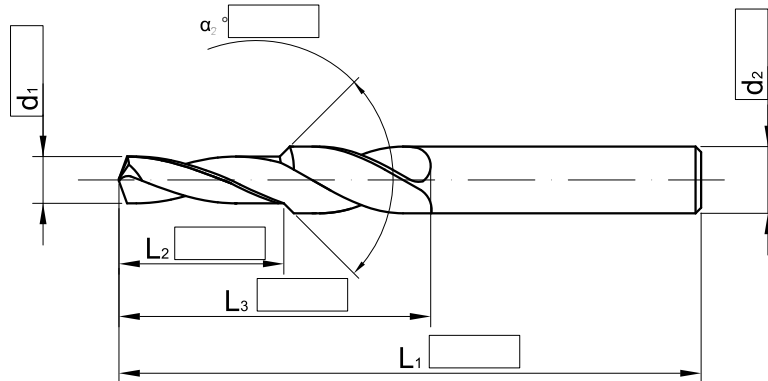

3. Execution:

3.1. Flutes: Right spiral Left spiral Straight Spiral angle:

3.2. Rotation direction: Right hand Left hand

3.3. Cooling: External Internal Non-cooling

3.4. Shank: DIN-6535-HA DIN-6535-HB DIN-65350HE

4. Machine:

4.1. Type of machine:

4.2. Type of spindle:

4.3. Power[kW]:

4.4. Max. rotating speed[RPM]:

5. Notes

Suggested price:

FORM OF TOOL SELECTION



FANAR fills

Date:..... Representative:..... Inq. nr

Date:

SPECIAL 2-STEP DRILL

CUSTOMER'S DATA

Name and company address:

Contact person:tel.....

1. Sketch of the machined part:

1.1. Name of detail:..... 1.2. Workpiece material:.....

1.3. Hardness:

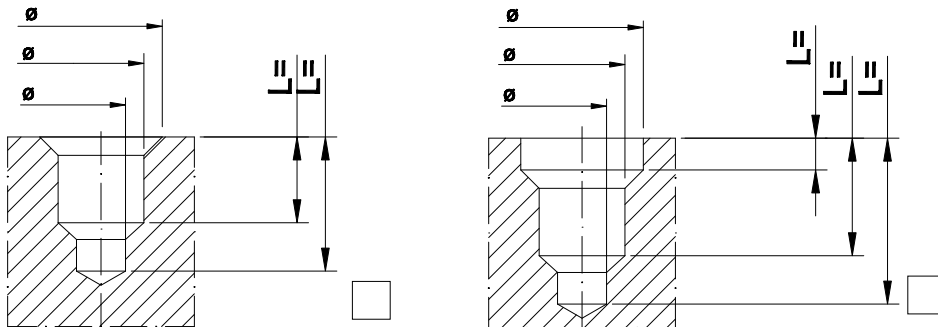

2. Tool:

2.1. Tool drawing nr:.....

2.2. Suggested material:

2.3. Suggested PVD coating:.....

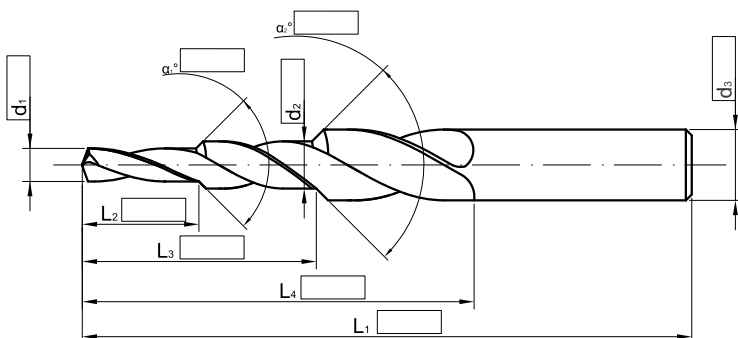

3. Execution:

- 3.1. Flutes: Right spiral Left spiral Straight Spiral angle:
- 3.2. Rotation direction: Right hand Left hand
- 3.3. Cooling: External Internal Non-cooling
- 3.4. Shank: DIN-6535-HA DIN-6535-HB DIN-65350HE

4. Machine:

- 4.1. Type of machine:
- 4.2. Type of spindle:
- 4.3. Power[kW]:
- 4.4. Max. rotating speed[RPM]:

5. Notes

.....

Suggested price:

FORM OF TOOL SELECTION



FANAR fills
 Date:..... Representative:..... Inq. nr

Date:

SPECIAL DRILL

CUSTOMER'S DATA

Name and company address:

Contact person:tel.....

1. Sketch of the machined part:

1.1. Name of detail:..... 1.2. Workpiece material:.....

1.3. Hardness:

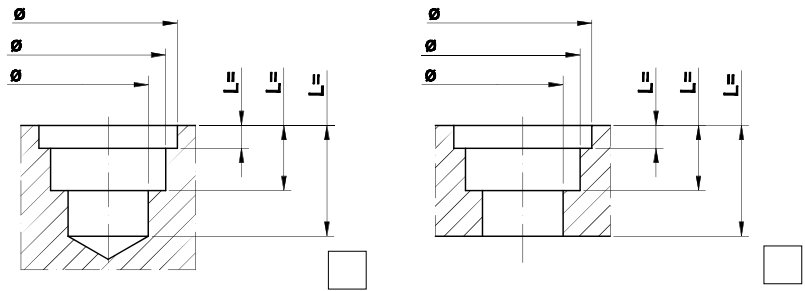

2. Tool:

2.1. Tool drawing nr:.....

2.2. Suggested material:

2.3. Suggested PVD coating:.....

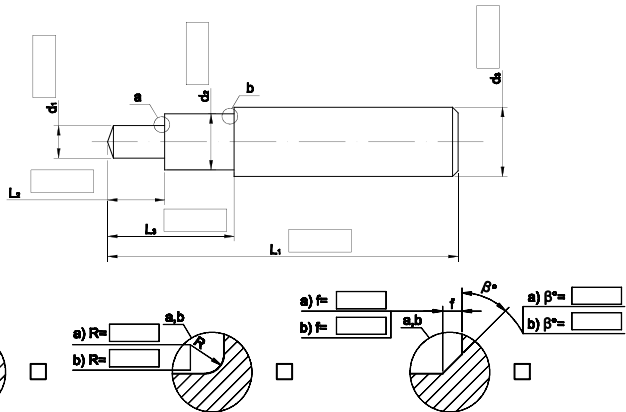

3. Execution:

- 3.1. Flutes: Right spiral Left spiral Straight Spiral angle:
- 3.2. Rotation direction: Right hand Left hand
- 3.3. Cooling: External Internal Non-cooling
- 3.4. Shank: DIN-6535-HA DIN-6535-HB DIN-65350HE

4. Machine:

- 4.1. Type of machine:
- 4.2. Type of spindle:
- 4.3. Power[kW]:
- 4.4. Max. rotating speed[RPM]:

5. Notes

Suggested price:

